

Catalogue

supermagnete.de



Dear Customer

We offer you the strongest magnets in many shapes and sizes. Nearly all of our magnets are made of Neodymium Iron Boron (NdFeB). These are the strongest permanent magnets in existence. They are many times stronger than typical magnets.

You have to experience these magnets yourself in order to understand why they are called "super magnets".

This catalogue displays the same articles that are available in our web shop. You can find more detailed information and additional photos in the item descriptions at www.supermagnete.de. We have made every effort to simplify the order process for you.

I hope you enjoy your shopping experience!

Marion Zollinger, Chief Executive Officer

Our Mailing Address (not a store!):

supermagnete.de

Webcraft GmbH

Industriepark 206

78244 Gottmadingen

Germany

Tel. +49 7731 939 839 2

support@supermagnete.de

Validity of product pricing

The product prices shown here match the shop prices effective on 26.01.2021. We strive to provide a high degree of price stability but are subject to market-based price fluctuations which can be attributed to trends in raw material pricing or currency fluctuations, for instance. For information on current prices, we recommend you look them up in the shop under www.supermagnete.de or call our customer service at +49 7731 939 839 2.

Disc magnets neodymium

<p>S-01-01-N Disc magnet Ø 1 mm, height 1 mm Weight: 0,006 g Nickel-plated (Ni-Cu-Ni) Magnetisation: N45 strength: approx. 31 g</p>	<p>Price in EUR 20 pcs. 0,21 ea. from 60 pcs. 0,17 ea. from 140 pcs. 0,15 ea. from 360 pcs. 0,13 ea.</p>	<p>They don't come much smaller than this! Here comes the equivalent to our smallest cube. It's hard to believe, but this little disc magnet is strong enough to pin a little note to the wall.</p>
<p>S-1.5-0.5-N Disc magnet Ø 1,5 mm, height 0,5 mm Weight: 0,0067 g Nickel-plated (Ni-Cu-Ni) Magnetisation: N45 strength: approx. 33 g</p>	<p>Price in EUR 20 pcs. 0,25 ea. from 60 pcs. 0,21 ea. from 140 pcs. 0,18 ea. from 360 pcs. 0,16 ea.</p>	
<p>S-02-0.7-N Disc magnet Ø 2 mm, height 0,7 mm Weight: 0,017 g Nickel-plated (Ni-Cu-Ni) Magnetisation: N45 strength: approx. 74 g</p>	<p>Price in EUR 20 pcs. 0,25 ea. from 60 pcs. 0,21 ea. from 140 pcs. 0,18 ea. from 360 pcs. 0,15 ea.</p>	
<p>S-02-01-N Disc magnet Ø 2 mm, height 1 mm Weight: 0,024 g Nickel-plated (Ni-Cu-Ni) Magnetisation: N48 strength: approx. 110 g</p>	<p>Price in EUR 20 pcs. 0,22 ea. from 60 pcs. 0,18 ea. from 140 pcs. 0,16 ea. from 360 pcs. 0,14 ea.</p>	<p>Bestseller: More than 2 million sold!</p>
<p>S-02-02-N Disc magnet Ø 2 mm, height 2 mm Weight: 0,048 g Nickel-plated (Ni-Cu-Ni) Magnetisation: N48 strength: approx. 150 g</p>	<p>Price in EUR 20 pcs. 0,23 ea. from 60 pcs. 0,19 ea. from 140 pcs. 0,17 ea. from 360 pcs. 0,14 ea.</p>	
<p>S-2.5-01-N52N Disc magnet Ø 2,5 mm, height 1 mm Weight: 0,037 g Nickel-plated (Ni-Cu-Ni) Magnetisation: N52 strength: approx. 160 g</p>	<p>Price in EUR 20 pcs. 0,24 ea. from 60 pcs. 0,20 ea. from 140 pcs. 0,18 ea. from 360 pcs. 0,15 ea.</p>	<p>A tiny disc magnet with extremely strong N52 magnetisation.</p>
<p>S-03-01-N Disc magnet Ø 3 mm, height 1 mm Weight: 0,054 g Nickel-plated (Ni-Cu-Ni) Magnetisation: N48 strength: approx. 190 g</p>	<p>Price in EUR 20 pcs. 0,23 ea. from 60 pcs. 0,19 ea. from 140 pcs. 0,16 ea. from 360 pcs. 0,14 ea.</p>	<p>We now carry this pipsqueak with a weight of 0,05 g at the request of our customers from the model-maker scene.</p>
<p>S-03-02-N Disc magnet Ø 3 mm, height 2 mm Weight: 0,11 g Nickel-plated (Ni-Cu-Ni) Magnetisation: N48 strength: approx. 300 g</p>	<p>Price in EUR 20 pcs. 0,25 ea. from 60 pcs. 0,20 ea. from 140 pcs. 0,18 ea. from 360 pcs. 0,15 ea.</p>	

<p>S-03-03-N Disc magnet Ø 3 mm, height 3 mm Weight: 0,16 g Nickel-plated (Ni-Cu-Ni) Magnetisation: N45 strength: approx. 330 g</p>	<p>Price in EUR 20 pcs. 0,25 ea. from 60 pcs. 0,21 ea. from 140 pcs. 0,18 ea. from 360 pcs. 0,16 ea.</p>	
<p>S-04-01-N Disc magnet Ø 4 mm, height 1 mm Weight: 0,096 g Nickel-plated (Ni-Cu-Ni) Magnetisation: N45 strength: approx. 250 g</p>	<p>Price in EUR 20 pcs. 0,24 ea. from 60 pcs. 0,20 ea. from 140 pcs. 0,17 ea. from 360 pcs. 0,15 ea.</p>	Tiny disc magnet. Still holds 2 A4 sheets!
<p>S-04-1.5-N Disc magnet Ø 4 mm, height 1,5 mm Weight: 0,14 g Nickel-plated (Ni-Cu-Ni) Magnetisation: N45 strength: approx. 350 g</p>	<p>Price in EUR 40 pcs. 0,19 ea. from 80 pcs. 0,17 ea. from 160 pcs. 0,16 ea.</p>	
<p>S-04-02-N Disc magnet Ø 4 mm, height 2 mm Weight: 0,19 g Nickel-plated (Ni-Cu-Ni) Magnetisation: N45 strength: approx. 420 g</p>	<p>Price in EUR 20 pcs. 0,25 ea. from 60 pcs. 0,21 ea. from 140 pcs. 0,18 ea. from 360 pcs. 0,16 ea.</p>	Bestseller: More than 4,75 million sold!
<p>S-04-03-N Disc magnet Ø 4 mm, height 3 mm Weight: 0,29 g Nickel-plated (Ni-Cu-Ni) Magnetisation: N45 strength: approx. 530 g</p>	<p>Price in EUR 10 pcs. 0,26 ea. from 40 pcs. 0,21 ea. from 80 pcs. 0,19 ea. from 160 pcs. 0,17 ea.</p>	
<p>S-04-04-N Disc magnet Ø 4 mm, height 4 mm Weight: 0,38 g Nickel-plated (Ni-Cu-Ni) Magnetisation: N45 strength: approx. 590 g</p>	<p>Price in EUR 20 pcs. 0,28 ea. from 60 pcs. 0,24 ea. from 140 pcs. 0,21 ea. from 360 pcs. 0,18 ea.</p>	
<p>S-05-01-N Disc magnet Ø 5 mm, height 1 mm Weight: 0,15 g Nickel-plated (Ni-Cu-Ni) Magnetisation: N45 strength: approx. 320 g</p>	<p>Price in EUR 10 pcs. 0,28 ea. from 40 pcs. 0,23 ea. from 80 pcs. 0,20 ea. from 160 pcs. 0,18 ea.</p>	
<p>S-05-02-N40N Disc magnet Ø 5 mm, height 2 mm Weight: 0,3 g Nickel-plated (Ni-Cu-Ni) Magnetisation: N40 strength: approx. 520 g</p>	<p>Price in EUR 10 pcs. 0,31 ea. from 40 pcs. 0,25 ea. from 80 pcs. 0,22 ea. from 160 pcs. 0,20 ea.</p>	Same article as S-05-02-N52N, but with weaker magnetisation (N40 instead of N52).
<p>S-05-02-N52N Disc magnet Ø 5 mm, height 2 mm Weight: 0,3 g Nickel-plated (Ni-Cu-Ni) Magnetisation: N52 strength: approx. 680 g</p>	<p>Price in EUR 10 pcs. 0,31 ea. from 40 pcs. 0,25 ea. from 80 pcs. 0,22 ea. from 160 pcs. 0,20 ea.</p>	Small disc magnet with extremely strong N52 magnetisation. Holds 6 pieces of A4 paper to a metal wall. It will hold a single piece of paper, a note, or a recipe very firmly in place.

<p>S-05-03-N Disc magnet Ø 5 mm, height 3 mm Weight: 0,45 g Nickel-plated (Ni-Cu-Ni) Magnetisation: N42 strength: approx. 700 g</p>	<p>Price in EUR 10 pcs. 0,32 ea. from 40 pcs. 0,26 ea. from 80 pcs. 0,23 ea. from 160 pcs. 0,21 ea.</p>	<p>More than 5,6 million sold</p>
<p>S-05-04-N Disc magnet Ø 5 mm, height 4 mm Weight: 0,6 g Nickel-plated (Ni-Cu-Ni) Magnetisation: N45 strength: approx. 860 g</p>	<p>Price in EUR 10 pcs. 0,35 ea. from 40 pcs. 0,28 ea. from 80 pcs. 0,25 ea. from 160 pcs. 0,23 ea.</p>	
<p>S-05-05-N Disc magnet Ø 5 mm, height 5 mm Weight: 0,75 g Nickel-plated (Ni-Cu-Ni) Magnetisation: N45 strength: approx. 940 g</p>	<p>Price in EUR 20 pcs. 0,31 ea. from 60 pcs. 0,27 ea. from 140 pcs. 0,24 ea. from 360 pcs. 0,21 ea.</p>	<p>Even this small magnet, which weighs less than 1 gramme, is able to attract another magnet through a human finger.</p>
<p>S-05-05-T Disc magnet Ø 5 mm, height 5 mm Weight: 0,75 g teflon-coated Magnetisation: N45 strength: approx. 940 g</p>	<p>Price in EUR 10 pcs. 0,48 ea. from 40 pcs. 0,39 ea. from 80 pcs. 0,35 ea. from 160 pcs. 0,32 ea.</p>	<p>Its Teflon coating gives this disc magnet a dark-grey colour. The Teflon makes the magnet nearly waterproof and very abrasion-proof.</p>
<p>S-06-01-N Disc magnet Ø 6 mm, height 1 mm Weight: 0,21 g Nickel-plated (Ni-Cu-Ni) Magnetisation: N45 strength: approx. 400 g</p>	<p>Price in EUR 20 pcs. 0,26 ea. from 60 pcs. 0,22 ea. from 140 pcs. 0,19 ea. from 360 pcs. 0,16 ea.</p>	<p>The extra flat magnet for your crazy ideas! An invitation with an original magnetic closure? A box whose top closes as if by magic? You can realize these and many other ideas with our flattest disc magnet.</p>
<p>S-06-02-G Disc magnet Ø 6 mm, height 2 mm Weight: 0,43 g Gold-plated (Ni-Cu-Ni-Au) Magnetisation: N45 strength: approx. 740 g</p>	<p>Price in EUR 10 pcs. 0,35 ea. from 40 pcs. 0,29 ea. from 80 pcs. 0,26 ea. from 160 pcs. 0,23 ea.</p>	
<p>S-06-02-N Disc magnet Ø 6 mm, height 2 mm Weight: 0,43 g Nickel-plated (Ni-Cu-Ni) Magnetisation: N45 strength: approx. 740 g</p>	<p>Price in EUR 10 pcs. 0,32 ea. from 40 pcs. 0,26 ea. from 80 pcs. 0,23 ea. from 160 pcs. 0,21 ea.</p>	<p>Extra super strong (=N45) disc magnet. Even such a pipsqueak can hold 7 pieces of A4 paper (80g/m²) to a metal plate (see photos).</p>
<p>S-06-03-N Disc magnet Ø 6 mm, height 3 mm Weight: 0,64 g Nickel-plated (Ni-Cu-Ni) Magnetisation: N45 strength: approx. 990 g</p>	<p>Price in EUR 10 pcs. 0,35 ea. from 40 pcs. 0,28 ea. from 80 pcs. 0,25 ea. from 160 pcs. 0,23 ea.</p>	
<p>S-06-04-N Disc magnet Ø 6 mm, height 4 mm Weight: 0,86 g Nickel-plated (Ni-Cu-Ni) Magnetisation: N45 strength: approx. 1,2 kg</p>	<p>Price in EUR 10 pcs. 0,37 ea. from 40 pcs. 0,30 ea. from 80 pcs. 0,27 ea. from 160 pcs. 0,25 ea.</p>	

<p>S-06-06-N Disc magnet Ø 6 mm, height 6 mm Weight: 1,3 g Nickel-plated (Ni-Cu-Ni) Magnetisation: N48 strength: approx. 1,5 kg</p>	<p>Price in EUR 10 pcs. 0,44 ea. from 40 pcs. 0,36 ea. from 80 pcs. 0,33 ea. from 160 pcs. 0,30 ea.</p>	
<p>S-08-01-N Disc magnet Ø 8 mm, height 1 mm Weight: 0,38 g Nickel-plated (Ni-Cu-Ni) Magnetisation: N45 strength: approx. 540 g</p>	<p>Price in EUR 10 pcs. 0,32 ea. from 40 pcs. 0,25 ea. from 80 pcs. 0,23 ea. from 160 pcs. 0,20 ea.</p>	
<p>S-08-02-N Disc magnet Ø 8 mm, height 2 mm Weight: 0,76 g Nickel-plated (Ni-Cu-Ni) Magnetisation: N45 strength: approx. 1,1 kg</p>	<p>Price in EUR 20 pcs. 0,32 ea. from 60 pcs. 0,27 ea. from 140 pcs. 0,24 ea. from 360 pcs. 0,21 ea.</p>	<p>A small flat neodymium magnet with an adhesive force of about 1 kg. Our customers use it, for instance, for magnetic buttons or manual training in school.</p>
<p>S-08-03-G Disc magnet Ø 8 mm, height 3 mm Weight: 1,1 g Gold-plated (Ni-Cu-Ni-Au) Magnetisation: N40 strength: approx. 1,3 kg</p>	<p>Price in EUR 10 pcs. 0,43 ea. from 40 pcs. 0,36 ea. from 80 pcs. 0,32 ea. from 160 pcs. 0,29 ea.</p>	
<p>S-08-03-E Disc magnet Ø 8 mm, height 3 mm Weight: 1,1 g Epoxy coating (Ni-Cu-Ni-Epoxy) Magnetisation: N45 strength: approx. 1,5 kg</p>	<p>Price in EUR 10 pcs. 0,42 ea. from 40 pcs. 0,35 ea. from 80 pcs. 0,32 ea. from 160 pcs. 0,29 ea.</p>	<p>A disc magnet 8 x 3 mm with a Ni-Cu-Ni base coating and a top coat of black epoxy resin. It can be glued or cast with epoxy resin.</p>
<p>S-08-03-N Disc magnet Ø 8 mm, height 3 mm Weight: 1,1 g Nickel-plated (Ni-Cu-Ni) Magnetisation: N45 strength: approx. 1,5 kg</p>	<p>Price in EUR 20 pcs. 0,34 ea. from 60 pcs. 0,29 ea. from 140 pcs. 0,26 ea. from 360 pcs. 0,23 ea.</p>	<p>A good size for various craft projects, name tags at weddings, small refrigerator magnets, hanging-up posters...</p>
<p>S-08-04-N Disc magnet Ø 8 mm, height 4 mm Weight: 1,5 g Nickel-plated (Ni-Cu-Ni) Magnetisation: N45 strength: approx. 1,8 kg</p>	<p>Price in EUR 10 pcs. 0,42 ea. from 40 pcs. 0,35 ea. from 80 pcs. 0,32 ea. from 160 pcs. 0,29 ea.</p>	
<p>S-08-05-E Disc magnet Ø 8 mm, height 5 mm Weight: 1,9 g Epoxy coating (Ni-Cu-Ni-Epoxy) Magnetisation: N45 strength: approx. 2 kg</p>	<p>Price in EUR 10 pcs. 0,49 ea. from 40 pcs. 0,41 ea. from 80 pcs. 0,37 ea. from 160 pcs. 0,34 ea.</p>	
<p>S-08-05-N Disc magnet Ø 8 mm, height 5 mm Weight: 1,9 g Nickel-plated (Ni-Cu-Ni) Magnetisation: N45 strength: approx. 2 kg</p>	<p>Price in EUR 10 pcs. 0,47 ea. from 40 pcs. 0,38 ea. from 80 pcs. 0,35 ea. from 160 pcs. 0,32 ea.</p>	<p>A solid but small disc magnet with an adhesive force of 2 kg. A practical but safe size - one of our magnet bestsellers.</p>

<p>S-08-06-N52N Disc magnet Ø 8 mm, height 6 mm Weight: 2,3 g Nickel-plated (Ni-Cu-Ni) Magnetisation: N52 strength: approx. 2,6 kg</p>	<p>Price in EUR</p> <p>20 pcs. 0,55 ea. from 60 pcs. 0,48 ea. from 140 pcs. 0,43 ea. from 360 pcs. 0,38 ea.</p>	<p>Small, compact disc magnet with extremely strong N52 magnetisation. Despite its small size it can hold up to 2,5 kg!</p>
<p>S-08-08-K Disc magnet Ø 8 mm, height 8 mm Weight: 3,1 g copper-plated (Ni-Cu) Magnetisation: N45 strength: approx. 2,5 kg</p>	<p>Price in EUR</p> <p>10 pcs. 0,59 ea. from 40 pcs. 0,49 ea. from 80 pcs. 0,45 ea. from 160 pcs. 0,42 ea.</p>	<p>Strong disc magnets in trendy copper-colour! These magnets shimmer reddish-brown-golden and are the eye-catcher on glass magnetic boards and magnetic boards.</p>
<p>S-08-08-N Disc magnet Ø 8 mm, height 8 mm Weight: 3,1 g Nickel-plated (Ni-Cu-Ni) Magnetisation: N45 strength: approx. 2,5 kg</p>	<p>Price in EUR</p> <p>10 pcs. 0,59 ea. from 40 pcs. 0,49 ea. from 80 pcs. 0,45 ea. from 160 pcs. 0,42 ea.</p>	<p>This disc magnet works well on magnetic glass boards.</p>
<p>S-09-03-N52N Disc magnet Ø 9 mm, height 3 mm Weight: 1,5 g Nickel-plated (Ni-Cu-Ni) Magnetisation: N52 strength: approx. 2 kg</p>	<p>Price in EUR</p> <p>10 pcs. 0,50 ea. from 40 pcs. 0,41 ea. from 80 pcs. 0,38 ea. from 160 pcs. 0,35 ea.</p>	<p>The small flat disc magnet with the extremely strong N52 magnetisation. Despite its small dimensions it features an adhesive force of almost 2 kg.</p>
<p>S-09-05-N Disc magnet Ø 9 mm, height 5 mm Weight: 2,4 g Nickel-plated (Ni-Cu-Ni) Magnetisation: N50 strength: approx. 2,7 kg</p>	<p>Price in EUR</p> <p>10 pcs. 0,59 ea. from 40 pcs. 0,49 ea. from 80 pcs. 0,45 ea. from 160 pcs. 0,41 ea.</p>	
<p>S-10-0.6-N Disc magnet Ø 10 mm, height 0,6 mm Weight: 0,36 g Nickel-plated (Ni-Cu-Ni) Magnetisation: N35 strength: approx. 310 g</p>	<p>Price in EUR</p> <p>20 pcs. 0,28 ea. from 60 pcs. 0,24 ea. from 140 pcs. 0,21 ea. from 360 pcs. 0,18 ea.</p>	
<p>S-10-01-N Disc magnet Ø 10 mm, height 1 mm Weight: 0,6 g Nickel-plated (Ni-Cu-Ni) Magnetisation: N35 strength: approx. 540 g</p>	<p>Price in EUR</p> <p>20 pcs. 0,30 ea. from 60 pcs. 0,25 ea. from 140 pcs. 0,22 ea. from 360 pcs. 0,19 ea.</p>	
<p>S-10-1.5-N Disc magnet Ø 10 mm, height 1,5 mm Weight: 0,9 g Nickel-plated (Ni-Cu-Ni) Magnetisation: N42 strength: approx. 970 g</p>	<p>Price in EUR</p> <p>20 pcs. 0,33 ea. from 60 pcs. 0,28 ea. from 140 pcs. 0,25 ea. from 360 pcs. 0,22 ea.</p>	
<p>S-10-1.5-N52N Disc magnet Ø 10 mm, height 1,5 mm Weight: 0,9 g Nickel-plated (Ni-Cu-Ni) Magnetisation: N52 strength: approx. 1,2 kg</p>	<p>Price in EUR</p> <p>20 pcs. 0,37 ea. from 60 pcs. 0,31 ea. from 140 pcs. 0,28 ea. from 360 pcs. 0,25 ea.</p>	<p>This disc magnet looks identical to the S-10-1.5-N, but thanks to the N52 magnetisation it features an even higher adhesive force.</p>

<p>S-10-02-N Disc magnet Ø 10 mm, height 2 mm Weight: 1,2 g Nickel-plated (Ni-Cu-Ni) Magnetisation: N42 strength: approx. 1,3 kg</p>	<p>Price in EUR</p> <p>20 pcs. 0,35 ea. from 60 pcs. 0,30 ea. from 140 pcs. 0,27 ea. from 360 pcs. 0,24 ea.</p>	<p>An adhesive force of about 1 kg with a 10 mm diameter and a 2 mm thickness make this disc magnet a top seller. It might be because you can embed it nicely.</p>
<p>S-10-2.5-N Disc magnet Ø 10 mm, height 2,5 mm Weight: 1,5 g Nickel-plated (Ni-Cu-Ni) Magnetisation: N42 strength: approx. 1,6 kg</p>	<p>Price in EUR</p> <p>10 pcs. 0,41 ea. from 40 pcs. 0,34 ea. from 80 pcs. 0,31 ea. from 160 pcs. 0,28 ea.</p>	
<p>S-10-03-N Disc magnet Ø 10 mm, height 3 mm Weight: 1,8 g Nickel-plated (Ni-Cu-Ni) Magnetisation: N42 strength: approx. 1,8 kg</p>	<p>Price in EUR</p> <p>10 pcs. 0,45 ea. from 40 pcs. 0,37 ea. from 80 pcs. 0,33 ea. from 160 pcs. 0,31 ea.</p>	<p>This reasonably priced magnet is wonderfully suitable for various craft projects. If you, for example, glue it to glass beads, you will have a very strong refrigerator or whiteboard magnet that can easily hold 15 pieces of A4 paper!</p>
<p>S-10-03-N52N Disc magnet Ø 10 mm, height 3 mm Weight: 1,8 g Nickel-plated (Ni-Cu-Ni) Magnetisation: N52 strength: approx. 2,3 kg</p>	<p>Price in EUR</p> <p>10 pcs. 0,53 ea. from 40 pcs. 0,43 ea. from 80 pcs. 0,39 ea. from 160 pcs. 0,36 ea.</p>	<p>This disc magnet looks identical to the S-10-03-N, but possesses an even higher adhesive force, thanks to the N52 magnetisation, which makes it even more versatile</p>
<p>S-10-04-N Disc magnet Ø 10 mm, height 4 mm Weight: 2,4 g Nickel-plated (Ni-Cu-Ni) Magnetisation: N42 strength: approx. 2,3 kg</p>	<p>Price in EUR</p> <p>10 pcs. 0,51 ea. from 40 pcs. 0,42 ea. from 80 pcs. 0,39 ea. from 160 pcs. 0,35 ea.</p>	
<p>S-10-05-DN Disc magnet Ø 10 mm, height 5 mm Weight: 3 g Nickel-plated (Ni-Cu-Ni) Magnetisation: N45 strength: approx. 1 kg</p>	<p>Price in EUR</p> <p>5 pcs. 0,79 ea. from 15 pcs. 0,69 ea. from 40 pcs. 0,61 ea. from 80 pcs. 0,57 ea.</p>	<p>Diametrically magnetised disc magnet.</p>
<p>S-10-05-E Disc magnet Ø 10 mm, height 5 mm Weight: 3 g Epoxy coating (Ni-Cu-Ni-Epoxy) Magnetisation: N42 strength: approx. 2 kg</p>	<p>Price in EUR</p> <p>5 pcs. 0,70 ea. from 15 pcs. 0,62 ea. from 40 pcs. 0,56 ea. from 80 pcs. 0,52 ea.</p>	<p>A disc magnet 10 x 5 mm with a Ni-Cu-Ni base coating and a top coat of black epoxy resin. It can be glued or cast with epoxy resin.</p>
<p>S-10-05-N Disc magnet Ø 10 mm, height 5 mm Weight: 3 g Nickel-plated (Ni-Cu-Ni) Magnetisation: N42 strength: approx. 2,6 kg</p>	<p>Price in EUR</p> <p>10 pcs. 0,57 ea. from 40 pcs. 0,48 ea. from 80 pcs. 0,44 ea. from 160 pcs. 0,41 ea.</p>	<p>These handy all-purpose magnets are so nicely-sized and so strong for such an unbelievable price that there will be no excuse for finding yourself without them in an emergency. :-)</p>
<p>S-10-05-N52N Disc magnet Ø 10 mm, height 5 mm Weight: 3 g Nickel-plated (Ni-Cu-Ni) Magnetisation: N52 strength: approx. 3,3 kg</p>	<p>Price in EUR</p> <p>5 pcs. 0,74 ea. from 15 pcs. 0,63 ea. from 40 pcs. 0,56 ea. from 80 pcs. 0,51 ea.</p>	<p>This disc magnet looks identical to the S-10-05-N, but possesses an even higher adhesive force, thanks to the N52 magnetisation, which makes it even more versatile</p>

<p>S-10-10-N Disc magnet Ø 10 mm, height 10 mm Weight: 6 g Nickel-plated (Ni-Cu-Ni) Magnetisation: N45 strength: approx. 3,9 kg</p>	<p>Price in EUR</p> <p>5 pcs. 0,92 ea. from 15 pcs. 0,80 ea. from 40 pcs. 0,72 ea. from 80 pcs. 0,66 ea.</p>	<p>In between disc magnet and rod magnet. With almost 4 kg adhesive force extremely strong for its size. Great price-performance ratio.</p>
<p>S-12-01-N Disc magnet Ø 12 mm, height 1 mm Weight: 0,86 g Nickel-plated (Ni-Cu-Ni) Magnetisation: N42 strength: approx. 770 g</p>	<p>Price in EUR</p> <p>20 pcs. 0,34 ea. from 60 pcs. 0,29 ea. from 140 pcs. 0,26 ea. from 360 pcs. 0,23 ea.</p>	
<p>S-12-02-N Disc magnet Ø 12 mm, height 2 mm Weight: 1,7 g Nickel-plated (Ni-Cu-Ni) Magnetisation: N45 strength: approx. 1,7 kg</p>	<p>Price in EUR</p> <p>10 pcs. 0,46 ea. from 40 pcs. 0,38 ea. from 80 pcs. 0,35 ea. from 160 pcs. 0,32 ea.</p>	
<p>S-12-03-N Disc magnet Ø 12 mm, height 3 mm Weight: 2,6 g Nickel-plated (Ni-Cu-Ni) Magnetisation: N45 strength: approx. 2,4 kg</p>	<p>Price in EUR</p> <p>10 pcs. 0,35 ea. from 40 pcs. 0,30 ea. from 80 pcs. 0,28 ea. from 160 pcs. 0,26 ea.</p>	
<p>S-12-04-N Disc magnet Ø 12 mm, height 4 mm Weight: 3,4 g Nickel-plated (Ni-Cu-Ni) Magnetisation: N45 strength: approx. 3,1 kg</p>	<p>Price in EUR</p> <p>5 pcs. 0,69 ea. from 15 pcs. 0,60 ea. from 40 pcs. 0,53 ea. from 80 pcs. 0,49 ea.</p>	
<p>S-12-05-N Disc magnet Ø 12 mm, height 5 mm Weight: 4,3 g Nickel-plated (Ni-Cu-Ni) Magnetisation: N45 strength: approx. 3,6 kg</p>	<p>Price in EUR</p> <p>5 pcs. 0,76 ea. from 15 pcs. 0,65 ea. from 40 pcs. 0,58 ea. from 80 pcs. 0,53 ea.</p>	
<p>S-12-06-DN Disc magnet Ø 12 mm, height 6 mm Weight: 5,2 g Nickel-plated (Ni-Cu-Ni) Magnetisation: N42 strength: approx. 1,9 kg</p>	<p>Price in EUR</p> <p>5 pcs. 1,04 ea. from 15 pcs. 0,91 ea. from 40 pcs. 0,81 ea. from 80 pcs. 0,76 ea.</p>	<p>Diametrically magnetised disc magnet.</p>
<p>S-12-06-K Disc magnet Ø 12 mm, height 6 mm Weight: 5,2 g copper-plated (Ni-Cu) Magnetisation: N45 strength: approx. 4,1 kg</p>	<p>Price in EUR</p> <p>5 pcs. 0,88 ea. from 15 pcs. 0,77 ea. from 40 pcs. 0,68 ea. from 80 pcs. 0,63 ea.</p>	<p>Strong disc magnets in trendy copper-colour! These magnets shimmer reddish-brown-golden and are the eye-catcher on glass magnetic boards and magnetic boards.</p>
<p>S-12-06-N Disc magnet Ø 12 mm, height 6 mm Weight: 5,2 g Nickel-plated (Ni-Cu-Ni) Magnetisation: N45 strength: approx. 4,1 kg</p>	<p>Price in EUR</p> <p>5 pcs. 0,86 ea. from 15 pcs. 0,75 ea. from 40 pcs. 0,67 ea. from 80 pcs. 0,61 ea.</p>	<p>If you feel that it would be a good idea to hang the shopping list on the refrigerator with this magnet, then you haven't quite grasped the concept of super magnets: Forget it! You'll never be able to get it off the refrigerator with your bare hands!</p>

<p>S-12-08-N Disc magnet Ø 12 mm, height 8 mm Weight: 6,9 g Nickel-plated (Ni-Cu-Ni) Magnetisation: N45 strength: approx. 4,8 kg</p>	<p>Price in EUR</p> <p>5 pcs. 1,04 ea. from 15 pcs. 0,91 ea. from 40 pcs. 0,82 ea. from 80 pcs. 0,76 ea.</p>	
<p>S-12-10-N Disc magnet Ø 12 mm, height 10 mm Weight: 8,6 g Nickel-plated (Ni-Cu-Ni) Magnetisation: N45 strength: approx. 5,3 kg</p>	<p>Price in EUR</p> <p>5 pcs. 1,18 ea. from 15 pcs. 1,04 ea. from 40 pcs. 0,93 ea. from 80 pcs. 0,86 ea.</p>	
<p>S-13-01-N Disc magnet Ø 13 mm, height 1 mm Weight: 1 g Nickel-plated (Ni-Cu-Ni) Magnetisation: N45 strength: approx. 910 g</p>	<p>Price in EUR</p> <p>20 pcs. 0,35 ea. from 60 pcs. 0,30 ea. from 140 pcs. 0,26 ea. from 360 pcs. 0,23 ea.</p>	
<p>S-13-02-N Disc magnet Ø 13 mm, height 2 mm Weight: 2 g Nickel-plated (Ni-Cu-Ni) Magnetisation: N45 strength: approx. 1,8 kg</p>	<p>Price in EUR</p> <p>10 pcs. 0,48 ea. from 40 pcs. 0,40 ea. from 80 pcs. 0,37 ea. from 160 pcs. 0,34 ea.</p>	
<p>S-15-02-N Disc magnet Ø 15 mm, height 2 mm Weight: 2,7 g Nickel-plated (Ni-Cu-Ni) Magnetisation: N40 strength: approx. 1,9 kg</p>	<p>Price in EUR</p> <p>10 pcs. 0,56 ea. from 40 pcs. 0,47 ea. from 80 pcs. 0,43 ea. from 160 pcs. 0,39 ea.</p>	
<p>S-15-03-N Disc magnet Ø 15 mm, height 3 mm Weight: 4 g Nickel-plated (Ni-Cu-Ni) Magnetisation: N45 strength: approx. 3,2 kg</p>	<p>Price in EUR</p> <p>5 pcs. 0,73 ea. from 15 pcs. 0,63 ea. from 40 pcs. 0,56 ea. from 80 pcs. 0,52 ea.</p>	<p>Top seller! For this disc magnet with its adhesive force of approx. 3 kg, normal whiteboard and magnetic board applications do not present a real challenge. This magnet is simply created for a higher purpose and it favours a heavier burden.</p>
<p>S-15-03-N52N Disc magnet Ø 15 mm, height 3 mm Weight: 4 g Nickel-plated (Ni-Cu-Ni) Magnetisation: N52 strength: approx. 3,7 kg</p>	<p>Price in EUR</p> <p>5 pcs. 0,91 ea. from 15 pcs. 0,78 ea. from 40 pcs. 0,69 ea. from 80 pcs. 0,63 ea.</p>	<p>This disc magnet looks identical to the S-15-03-N, but possesses an even higher adhesive force, thanks to the N52 magnetisation, which makes it even more versatile</p>
<p>S-15-05-N Disc magnet Ø 15 mm, height 5 mm Weight: 6,7 g Nickel-plated (Ni-Cu-Ni) Magnetisation: N42 strength: approx. 4,5 kg</p>	<p>Price in EUR</p> <p>5 pcs. 0,98 ea. from 15 pcs. 0,86 ea. from 40 pcs. 0,77 ea. from 80 pcs. 0,71 ea.</p>	<p>This inconspicuous disc magnet has an adhesive force of more than 4 kg and can be easily embedded. A great price-performance ratio!</p>
<p>S-15-08-K Disc magnet Ø 15 mm, height 8 mm Weight: 11 g copper-plated (Ni-Cu) Magnetisation: N42 strength: approx. 6,2 kg</p>	<p>Price in EUR</p> <p>5 pcs. 1,26 ea. from 15 pcs. 1,11 ea. from 40 pcs. 0,99 ea. from 80 pcs. 0,92 ea.</p>	<p>Strong disc magnets in trendy copper-colour! These magnets shimmer reddish-brown-golden and are the eye-catcher on glass magnetic boards, on which they securely hold even cardboard.</p>

<p>S-15-08-N Disc magnet Ø 15 mm, height 8 mm Weight: 11 g Nickel-plated (Ni-Cu-Ni) Magnetisation: N42 strength: approx. 6,2 kg</p>	<p>Price in EUR</p> <p>5 pcs. 1,30 ea. from 15 pcs. 1,14 ea. from 40 pcs. 1,02 ea. from 80 pcs. 0,95 ea.</p>	<p>A good in-between size! Not so painfully big, but definitely impressively strong. This magnet can hold 35 sheets of A4 paper on a metal cabinet. If this one is not going to be a big hit, I'll go get another job.</p>
<p>S-18-02-N Disc magnet Ø 18 mm, height 2 mm Weight: 3,9 g Nickel-plated (Ni-Cu-Ni) Magnetisation: N45 strength: approx. 2,6 kg</p>	<p>Price in EUR</p> <p>5 pcs. 0,81 ea. from 15 pcs. 0,71 ea. from 40 pcs. 0,63 ea. from 80 pcs. 0,58 ea.</p>	
<p>S-20-1.5-N Disc magnet Ø 20 mm, height 1,5 mm Weight: 3,6 g Nickel-plated (Ni-Cu-Ni) Magnetisation: N38 strength: approx. 1,8 kg</p>	<p>Price in EUR</p> <p>5 pcs. 0,70 ea. from 15 pcs. 0,60 ea. from 40 pcs. 0,53 ea. from 80 pcs. 0,49 ea.</p>	
<p>S-20-02-N Disc magnet Ø 20 mm, height 2 mm Weight: 4,8 g Nickel-plated (Ni-Cu-Ni) Magnetisation: N45 strength: approx. 2,9 kg</p>	<p>Price in EUR</p> <p>5 pcs. 0,88 ea. from 15 pcs. 0,77 ea. from 40 pcs. 0,68 ea. from 80 pcs. 0,63 ea.</p>	<p>An extremely flat disc magnet with an adhesive force of 2 kg. Affordable and discreet - one of our bestsellers! Perfect for closures and fasteners of all kind.</p>
<p>S-20-02-N52N Disc magnet Ø 20 mm, height 2 mm Weight: 4,8 g Nickel-plated (Ni-Cu-Ni) Magnetisation: N52 strength: approx. 3,4 kg</p>	<p>Price in EUR</p> <p>5 pcs. 1,02 ea. from 15 pcs. 0,88 ea. from 40 pcs. 0,79 ea. from 80 pcs. 0,73 ea.</p>	<p>This disc magnet looks identical to the S-20-02-N, but possesses an even higher adhesive force, thanks to the N52 magnetisation, which makes it even more versatile</p>
<p>S-20-03-N Disc magnet Ø 20 mm, height 3 mm Weight: 7,2 g Nickel-plated (Ni-Cu-Ni) Magnetisation: N45 strength: approx. 4,3 kg</p>	<p>Price in EUR</p> <p>5 pcs. 1,08 ea. from 15 pcs. 0,95 ea. from 40 pcs. 0,85 ea. from 80 pcs. 0,79 ea.</p>	
<p>S-20-04-N Disc magnet Ø 20 mm, height 4 mm Weight: 9,6 g Nickel-plated (Ni-Cu-Ni) Magnetisation: N42 strength: approx. 5,3 kg</p>	<p>Price in EUR</p> <p>5 pcs. 1,32 ea. from 15 pcs. 1,16 ea. from 40 pcs. 1,04 ea. from 80 pcs. 0,97 ea.</p>	
<p>S-20-05-T Disc magnet Ø 20 mm, height 5 mm Weight: 12 g teflon-coated Magnetisation: N42 strength: approx. 6,4 kg</p>	<p>Price in EUR</p> <p>5 pcs. 1,58 ea. from 15 pcs. 1,40 ea. from 40 pcs. 1,27 ea. from 80 pcs. 1,18 ea.</p>	<p>Its Teflon coating gives this disc magnet a dark-grey colour. The Teflon makes the magnet nearly waterproof and very abrasion-proof.</p>
<p>S-20-05-N Disc magnet Ø 20 mm, height 5 mm Weight: 12 g Nickel-plated (Ni-Cu-Ni) Magnetisation: N42 strength: approx. 6,4 kg</p>	<p>Price in EUR</p> <p>5 pcs. 1,36 ea. from 15 pcs. 1,20 ea. from 40 pcs. 1,07 ea. from 80 pcs. 1,00 ea.</p>	<p>If you have to keep an eye on the thickness, for example, embedding a magnet in a cabinet door, then this 5 mm thin magnet is just the thing... and it still has an impressive attractive force!</p>

S-20-06-N		Price in EUR	
Disc magnet Ø 20 mm, height 6 mm		1 pc.	2,11 ea.
Weight: 14 g	from	3 pcs.	1,84 ea.
Nickel-plated (Ni-Cu-Ni)	from	10 pcs.	1,61 ea.
Magnetisation: N42	from	20 pcs.	1,50 ea.
strength: approx. 7,5 kg	from	40 pcs.	1,40 ea.
S-20-07-N		Price in EUR	
Disc magnet Ø 20 mm, height 7 mm		5 pcs.	1,82 ea.
Weight: 17 g	from	15 pcs.	1,60 ea.
Nickel-plated (Ni-Cu-Ni)	from	40 pcs.	1,44 ea.
Magnetisation: N42	from	80 pcs.	1,34 ea.
strength: approx. 8,4 kg			
S-20-08-N		Price in EUR	
Disc magnet Ø 20 mm, height 8 mm		1 pc.	2,58 ea.
Weight: 19 g	from	3 pcs.	2,26 ea.
Nickel-plated (Ni-Cu-Ni)	from	10 pcs.	1,98 ea.
Magnetisation: N42	from	20 pcs.	1,85 ea.
strength: approx. 9,3 kg	from	40 pcs.	1,73 ea.
S-20-09-N		Price in EUR	
Disc magnet Ø 20 mm, height 9 mm		1 pc.	2,81 ea.
Weight: 21 g	from	3 pcs.	2,47 ea.
Nickel-plated (Ni-Cu-Ni)	from	10 pcs.	2,17 ea.
Magnetisation: N42	from	20 pcs.	2,02 ea.
strength: approx. 10 kg	from	40 pcs.	1,89 ea.
S-20-10-N		Price in EUR	Wow! With this item you definitely get the most bang for your buck! Hard core! And a very good value (such prices are almost indecent).
Disc magnet Ø 20 mm, height 10 mm		1 pc.	2,90 ea.
Weight: 24 g	from	3 pcs.	2,54 ea.
Nickel-plated (Ni-Cu-Ni)	from	10 pcs.	2,22 ea.
Magnetisation: N42	from	20 pcs.	2,06 ea.
strength: approx. 11 kg	from	40 pcs.	1,92 ea.
S-20-12-N		Price in EUR	
Disc magnet Ø 20 mm, height 12 mm		1 pc.	3,49 ea.
Weight: 29 g	from	3 pcs.	3,08 ea.
Nickel-plated (Ni-Cu-Ni)	from	10 pcs.	2,72 ea.
Magnetisation: N42	from	20 pcs.	2,54 ea.
strength: approx. 12 kg	from	40 pcs.	2,38 ea.
S-20-15-N		Price in EUR	
Disc magnet Ø 20 mm, height 15 mm		1 pc.	4,16 ea.
Weight: 36 g	from	3 pcs.	3,68 ea.
Nickel-plated (Ni-Cu-Ni)	from	10 pcs.	3,25 ea.
Magnetisation: N42	from	20 pcs.	3,04 ea.
strength: approx. 13 kg	from	40 pcs.	2,86 ea.
S-20-20-N		Price in EUR	
Disc magnet Ø 20 mm, height 20 mm		1 pc.	5,17 ea.
Weight: 48 g	from	3 pcs.	4,57 ea.
Nickel-plated (Ni-Cu-Ni)	from	10 pcs.	4,03 ea.
Magnetisation: N42	from	20 pcs.	3,77 ea.
strength: approx. 15 kg	from	40 pcs.	3,54 ea.
S-25-02-N		Price in EUR	
Disc magnet Ø 25 mm, height 2 mm		5 pcs.	1,15 ea.
Weight: 7,5 g	from	15 pcs.	1,01 ea.
Nickel-plated (Ni-Cu-Ni)	from	40 pcs.	0,91 ea.
Magnetisation: N38	from	80 pcs.	0,85 ea.
strength: approx. 3,1 kg			

<p>S-25-03-N Disc magnet Ø 25 mm, height 3 mm Weight: 11 g Nickel-plated (Ni-Cu-Ni) Magnetisation: N45 strength: approx. 5,5 kg</p>	<p>Price in EUR</p> <p>5 pcs. 1,50 ea. from 15 pcs. 1,32 ea. from 40 pcs. 1,19 ea. from 80 pcs. 1,11 ea.</p>	
<p>S-25-05-N Disc magnet Ø 25 mm, height 5 mm Weight: 19 g Nickel-plated (Ni-Cu-Ni) Magnetisation: N42 strength: approx. 8,3 kg</p>	<p>Price in EUR</p> <p>1 pc. 2,58 ea. from 3 pcs. 2,25 ea. from 10 pcs. 1,96 ea. from 20 pcs. 1,82 ea. from 40 pcs. 1,70 ea.</p>	<p>The S-25-05-N is a real power pack: With an adhesive force of 8,8 kg, it is suitable for both industrial and specific applications that call for extraordinary adhesive force.</p>
<p>S-25-07-N Disc magnet Ø 25 mm, height 7 mm Weight: 26 g Nickel-plated (Ni-Cu-Ni) Magnetisation: N42 strength: approx. 11 kg</p>	<p>Price in EUR</p> <p>1 pc. 3,31 ea. from 3 pcs. 2,90 ea. from 10 pcs. 2,53 ea. from 20 pcs. 2,35 ea. from 40 pcs. 2,19 ea.</p>	
<p>S-30-03-N Disc magnet Ø 30 mm, height 3 mm Weight: 16 g Nickel-plated (Ni-Cu-Ni) Magnetisation: N45 strength: approx. 6,7 kg</p>	<p>Price in EUR</p> <p>1 pc. 2,40 ea. from 3 pcs. 2,11 ea. from 10 pcs. 1,84 ea. from 20 pcs. 1,72 ea. from 40 pcs. 1,60 ea.</p>	
<p>S-30-07-N Disc magnet Ø 30 mm, height 7 mm Weight: 38 g Nickel-plated (Ni-Cu-Ni) Magnetisation: N42 strength: approx. 14 kg</p>	<p>Price in EUR</p> <p>1 pc. 4,41 ea. from 3 pcs. 3,88 ea. from 10 pcs. 3,41 ea. from 20 pcs. 3,18 ea. from 40 pcs. 2,98 ea.</p>	
<p>S-30-10-N Disc magnet Ø 30 mm, height 10 mm Weight: 54 g Nickel-plated (Ni-Cu-Ni) Magnetisation: N45 strength: approx. 20 kg</p>	<p>Price in EUR</p> <p>1 pc. 6,16 ea. from 3 pcs. 5,47 ea. from 10 pcs. 4,86 ea. from 20 pcs. 4,56 ea. from 40 pcs. 4,30 ea.</p>	
<p>S-30-15-N Disc magnet Ø 30 mm, height 15 mm Weight: 81 g Nickel-plated (Ni-Cu-Ni) Magnetisation: N42 strength: approx. 24 kg</p>	<p>Price in EUR</p> <p>1 pc. 8,28 ea. from 3 pcs. 7,38 ea. from 10 pcs. 6,58 ea. from 20 pcs. 6,19 ea. from 40 pcs. 5,85 ea.</p>	
<p>S-35-05-N Disc magnet Ø 35 mm, height 5 mm Weight: 37 g Nickel-plated (Ni-Cu-Ni) Magnetisation: N42 strength: approx. 12 kg</p>	<p>Price in EUR</p> <p>1 pc. 4,52 ea. from 3 pcs. 3,98 ea. from 10 pcs. 3,50 ea. from 20 pcs. 3,26 ea. from 40 pcs. 3,06 ea.</p>	
<p>S-35-20-N Disc magnet Ø 35 mm, height 20 mm Weight: 150 g Nickel-plated (Ni-Cu-Ni) Magnetisation: N45 strength: approx. 38 kg</p>	<p>Price in EUR</p> <p>1 pc. 14,55 ea. from 3 pcs. 13,06 ea. from 10 pcs. 11,72 ea. from 20 pcs. 11,07 ea. from 40 pcs. 10,50 ea.</p>	

S-45-30-N Disc magnet Ø 45 mm, height 30 mm Weight: 360 g Nickel-plated (Ni-Cu-Ni) Magnetisation: N45 strength: approx. 69 kg	Price in EUR 1 pc. 32,34 ea. from 3 pcs. 29,25 ea. from 10 pcs. 26,50 ea. from 20 pcs. 25,16 ea. from 40 pcs. 23,97 ea.	Our second-strongest disc magnet. Given its holding power of 69 kg, one must naturally take extra care when handling these. With a diameter of 4,5 cm, this magnet hardly looks suspicious. Ah, but looks can be deceiving!
S-60-05-N Disc magnet Ø 60 mm, height 5 mm Weight: 110 g Nickel-plated (Ni-Cu-Ni) Magnetisation: N42 strength: approx. 21 kg	Price in EUR 1 pc. 11,98 ea. from 3 pcs. 10,73 ea. from 10 pcs. 9,61 ea. from 20 pcs. 9,06 ea. from 40 pcs. 8,58 ea.	
S-70-35-N Disc magnet Ø 70 mm, height 35 mm Weight: 1 kg Nickel-plated (Ni-Cu-Ni) Magnetisation: N45 strength: approx. 140 kg	Price in EUR 1 pc. 82,30 ea. from 3 pcs. 75,14 ea. from 10 pcs. 68,73 ea. from 20 pcs. 65,62 ea. from 40 pcs. 62,87 ea.	A power magnet full of extremes: The largest and strongest disc magnet we ever had in our assortment.

Rod magnets made of neodymium

All rod magnets have their north and south poles on the even circular surfaces (axial magnetisation). The sole exception is the S-04-10-DN, which is diametrically magnetised.

<p>S-02-03-N Rod magnet Ø 2 mm, height 3 mm Weight: 0,072 g Nickel-plated (Ni-Cu-Ni) Magnetisation: N45 strength: approx. 160 g</p>	<p>Price in EUR</p> <p>20 pcs. 0,21 ea. from 60 pcs. 0,18 ea. from 140 pcs. 0,15 ea. from 360 pcs. 0,13 ea.</p>	
<p>S-02-04-N Rod magnet Ø 2 mm, height 4 mm Weight: 0,096 g Nickel-plated (Ni-Cu-Ni) Magnetisation: N45 strength: approx. 160 g</p>	<p>Price in EUR</p> <p>20 pcs. 0,23 ea. from 60 pcs. 0,19 ea. from 140 pcs. 0,17 ea. from 360 pcs. 0,14 ea.</p>	
<p>S-02-05-N Rod magnet Ø 2 mm, height 5 mm Weight: 0,12 g Nickel-plated (Ni-Cu-Ni) Magnetisation: N45 strength: approx. 170 g</p>	<p>Price in EUR</p> <p>20 pcs. 0,23 ea. from 60 pcs. 0,19 ea. from 140 pcs. 0,17 ea. from 360 pcs. 0,15 ea.</p>	
<p>S-03-06-N Rod magnet Ø 3 mm, height 6 mm Weight: 0,32 g Nickel-plated (Ni-Cu-Ni) Magnetisation: N48 strength: approx. 400 g</p>	<p>Price in EUR</p> <p>20 pcs. 0,27 ea. from 60 pcs. 0,23 ea. from 140 pcs. 0,20 ea. from 360 pcs. 0,17 ea.</p>	
<p>S-03-08-N Rod magnet Ø 3 mm, height 8 mm Weight: 0,43 g Nickel-plated (Ni-Cu-Ni) Magnetisation: N48 strength: approx. 410 g</p>	<p>Price in EUR</p> <p>10 pcs. 0,34 ea. from 40 pcs. 0,28 ea. from 80 pcs. 0,25 ea. from 160 pcs. 0,23 ea.</p>	
<p>S-03-10-N Rod magnet Ø 3 mm, height 10 mm Weight: 0,54 g Nickel-plated (Ni-Cu-Ni) Magnetisation: N45 strength: approx. 390 g</p>	<p>Price in EUR</p> <p>20 pcs. 0,34 ea. from 60 pcs. 0,29 ea. from 140 pcs. 0,26 ea. from 360 pcs. 0,23 ea.</p>	
<p>S-04-05-Z Rod magnet Ø 4 mm, height 5 mm Weight: 0,48 g Zinc-plated (Ni-Cu-Ni-Zn) Magnetisation: N45 strength: approx. 630 g</p>	<p>Price in EUR</p> <p>20 pcs. 0,31 ea. from 60 pcs. 0,27 ea. from 140 pcs. 0,24 ea. from 360 pcs. 0,21 ea.</p>	<p>A small zinc-plated rod magnet: In addition to the normal Ni-Cu-Ni coating a layer of zinc is added, which gives the rod magnet a slightly blue and matt hue.</p>
<p>S-04-07-N Rod magnet Ø 4 mm, height 7 mm Weight: 0,67 g Nickel-plated (Ni-Cu-Ni) Magnetisation: N45 strength: approx. 670 g</p>	<p>Price in EUR</p> <p>20 pcs. 0,31 ea. from 60 pcs. 0,26 ea. from 140 pcs. 0,23 ea. from 360 pcs. 0,20 ea.</p>	

<p>S-04-10-AN Rod magnet Ø 4 mm, height 10 mm Weight: 0,96 g Nickel-plated (Ni-Cu-Ni) Magnetisation: N45 strength: approx. 700 g</p>	<p>Price in EUR 5 pcs. 0,46 ea. from 15 pcs. 0,39 ea. from 40 pcs. 0,34 ea. from 80 pcs. 0,31 ea.</p>	<p>These rod magnets axially magnetised.</p>
<p>S-04-10-DN Rod magnet Ø 4 mm, height 10 mm Weight: 0,96 g Nickel-plated (Ni-Cu-Ni) Magnetisation: N45 strength: approx. 1,1 kg</p>	<p>Price in EUR 10 pcs. 0,41 ea. from 40 pcs. 0,34 ea. from 80 pcs. 0,31 ea. from 160 pcs. 0,28 ea.</p>	<p>Please note: This rod magnet is diametrically magnetised. This means that these rods will not join end-to-end lengthwise, but rather side-by-side, like fish fingers.</p>
<p>S-04-13-N Rod magnet Ø 4 mm, height 12,5 mm Weight: 1,2 g Nickel-plated (Ni-Cu-Ni) Magnetisation: N42 strength: approx. 660 g</p>	<p>Price in EUR 10 pcs. 0,44 ea. from 40 pcs. 0,36 ea. from 80 pcs. 0,33 ea. from 160 pcs. 0,30 ea.</p>	<p>Small rod magnet, exactly half as long as the S-04-25-N.</p>
<p>S-04-25-N Rod magnet Ø 4 mm, height 25 mm Weight: 2,4 g Nickel-plated (Ni-Cu-Ni) Magnetisation: N42 strength: approx. 670 g</p>	<p>Price in EUR 5 pcs. 0,73 ea. from 15 pcs. 0,63 ea. from 40 pcs. 0,56 ea. from 80 pcs. 0,51 ea.</p>	<p>This slim rod magnet is wonderfully suitable for combining with steel spheres.</p>
<p>S-05-08-N Rod magnet Ø 5 mm, height 8,47 mm Weight: 1,3 g Nickel-plated (Ni-Cu-Ni) Magnetisation: N45 strength: approx. 1,1 kg</p>	<p>Price in EUR 10 pcs. 0,42 ea. from 40 pcs. 0,35 ea. from 80 pcs. 0,32 ea. from 160 pcs. 0,29 ea.</p>	<p>Very small, strong rod magnet. This magnet is especially suitable as a fridge magnet, for use on a magnetic board, or on a magnetic strip. It has an enormous adhesive force and is also comfortable to hold.</p>
<p>S-05-10-N Rod magnet Ø 5 mm, height 10 mm Weight: 1,5 g Nickel-plated (Ni-Cu-Ni) Magnetisation: N45 strength: approx. 1,1 kg</p>	<p>Price in EUR 10 pcs. 0,48 ea. from 40 pcs. 0,40 ea. from 80 pcs. 0,36 ea. from 160 pcs. 0,33 ea.</p>	
<p>S-05-13-N Rod magnet Ø 5 mm, height 12,5 mm Weight: 1,9 g Nickel-plated (Ni-Cu-Ni) Magnetisation: N45 strength: approx. 1,1 kg</p>	<p>Price in EUR 10 pcs. 0,53 ea. from 40 pcs. 0,44 ea. from 80 pcs. 0,41 ea. from 160 pcs. 0,37 ea.</p>	<p>Rod magnet, exactly half as long as S-05-25-N - in this photo, made into a tetrahedron combined with steel spheres.</p>
<p>S-05-14-N Rod magnet Ø 5 mm, height 13,96 mm Weight: 2,1 g Nickel-plated (Ni-Cu-Ni) Magnetisation: N45 strength: approx. 1,1 kg</p>	<p>Price in EUR 10 pcs. 0,58 ea. from 40 pcs. 0,48 ea. from 80 pcs. 0,44 ea. from 160 pcs. 0,40 ea.</p>	
<p>S-05-25-N Rod magnet Ø 5 mm, height 25 mm Weight: 3,7 g Nickel-plated (Ni-Cu-Ni) Magnetisation: N45 strength: approx. 1,1 kg</p>	<p>Price in EUR 5 pcs. 0,87 ea. from 15 pcs. 0,75 ea. from 40 pcs. 0,67 ea. from 80 pcs. 0,61 ea.</p>	<p>Rod magnet with 5 mm diameter, with even a stronger magnetisation than our 4 mm rods. In comparison with the 4 mm magnets, you can create even larger and more stable sculptures with these 5 mm rod magnets.</p>

<p>S-06-08-N Rod magnet Ø 6 mm, height 8 mm Weight: 1,7 g Nickel-plated (Ni-Cu-Ni) Magnetisation: N48 strength: approx. 1,6 kg</p>	<p>Price in EUR</p> <p>10 pcs. 0,52 ea. from 40 pcs. 0,43 ea. from 80 pcs. 0,39 ea. from 160 pcs. 0,36 ea.</p>	
<p>S-06-10-N Rod magnet Ø 6 mm, height 10 mm Weight: 2,1 g Nickel-plated (Ni-Cu-Ni) Magnetisation: N40 strength: approx. 1,4 kg</p>	<p>Price in EUR</p> <p>10 pcs. 0,57 ea. from 40 pcs. 0,47 ea. from 80 pcs. 0,43 ea. from 160 pcs. 0,40 ea.</p>	This magnet is well suited for a magnetic wall. It is strong but easy to grasp.
<p>S-06-13-N Rod magnet Ø 6 mm, height 13 mm Weight: 2,8 g Nickel-plated (Ni-Cu-Ni) Magnetisation: N48 strength: approx. 1,7 kg</p>	<p>Price in EUR</p> <p>5 pcs. 0,76 ea. from 15 pcs. 0,66 ea. from 40 pcs. 0,58 ea. from 80 pcs. 0,53 ea.</p>	Extra strong, small rod magnet. It is wonderfully suitable for attaching paper to a magnetic board or magnetic strip in a very secure and elegant manner.
<p>S-06-25-N Rod magnet Ø 6,35 mm, height 25,4 mm Weight: 6,1 g Nickel-plated (Ni-Cu-Ni) Magnetisation: N42 strength: approx. 1,7 kg</p>	<p>Price in EUR</p> <p>5 pcs. 1,18 ea. from 15 pcs. 1,03 ea. from 40 pcs. 0,92 ea. from 80 pcs. 0,85 ea.</p>	Strong rod magnets. In this photo with a steel sphere in the centre. Every rod magnet is so strong, that each can hold 80 additional rod magnets without a problem.
<p>S-08-30-N Rod magnet Ø 8 mm, height 30 mm Weight: 11 g Nickel-plated (Ni-Cu-Ni) Magnetisation: N42 strength: approx. 2,7 kg</p>	<p>Price in EUR</p> <p>5 pcs. 1,74 ea. from 15 pcs. 1,52 ea. from 40 pcs. 1,36 ea. from 80 pcs. 1,27 ea.</p>	
<p>SALE-126 Rod magnet Ø 9,37 mm, height 26,35 mm Weight: 14 g no coating Magnetisation: 45SH strength: approx. 4 kg</p>	<p>Price in EUR</p> <p>1 pc. 3,94 ea. from 3 pcs. 3,55 ea. from 10 pcs. 3,21 ea. from 20 pcs. 3,04 ea. from 40 pcs. 2,89 ea.</p>	Please note: This rod magnet is diametrically magnetised. This means that these rods will not join end-to-end lengthwise, but rather side-by-side, like fish fingers.
<p>S-10-20-N Rod magnet Ø 10 mm, height 20 mm Weight: 12 g Nickel-plated (Ni-Cu-Ni) Magnetisation: N45 strength: approx. 4,4 kg</p>	<p>Price in EUR</p> <p>1 pc. 2,57 ea. from 3 pcs. 2,23 ea. from 10 pcs. 1,93 ea. from 20 pcs. 1,78 ea. from 40 pcs. 1,65 ea.</p>	
<p>S-10-40-N Rod magnet Ø 10 mm, height 40 mm Weight: 24 g Nickel-plated (Ni-Cu-Ni) Magnetisation: N40 strength: approx. 4,1 kg</p>	<p>Price in EUR</p> <p>1 pc. 3,76 ea. from 3 pcs. 3,28 ea. from 10 pcs. 2,85 ea. from 20 pcs. 2,65 ea. from 40 pcs. 2,46 ea.</p>	
<p>S-12-60-N Rod magnet Ø 12 mm, height 60 mm Weight: 52 g Nickel-plated (Ni-Cu-Ni) Magnetisation: N38 strength: approx. 5,6 kg</p>	<p>Price in EUR</p> <p>1 pc. 9,84 ea. from 3 pcs. 8,67 ea. from 10 pcs. 7,63 ea. from 20 pcs. 7,13 ea. from 40 pcs. 6,68 ea.</p>	

S-15-100-N

Rod magnet Ø 15 mm,
height 100 mm
Weight: 130 g
Nickel-plated (Ni-Cu-Ni)
Magnetisation: N35
strength: approx. 8,2 kg

Price in EUR

	1 pc.	37,64 ea.
from	3 pcs.	33,63 ea.
from	10 pcs.	30,04 ea.
from	20 pcs.	28,30 ea.

Giant rod magnet.

The poles are located on the even circular areas.

The classic model for the old school experiment with iron filings.

Block magnets neodymium

<p>Q-05-1.5-01-N Block magnet 5 x 1,5 x 1 mm Weight: 0,057 g Nickel-plated (Ni-Cu-Ni) Magnetisation: N45 strength: approx. 140 g</p>	<p>Price in EUR</p> <p>20 pcs. 0,21 ea. from 60 pcs. 0,17 ea. from 140 pcs. 0,15 ea. from 360 pcs. 0,13 ea.</p>	<p>Although this magnet is capable of securing a piece of A4 paper or a business card to the wall, it's not really suitable for these tasks. Model builders are much happier to use this magnet in tuning their engines.</p>
<p>Q-05-2.5-1.5-HN Block magnet 5 x 2,5 x 1,5 mm Weight: 0,14 g Nickel-plated (Ni-Cu-Ni) Magnetisation: 44H strength: approx. 350 g</p>	<p>Price in EUR</p> <p>20 pcs. 0,24 ea. from 60 pcs. 0,20 ea. from 140 pcs. 0,17 ea. from 360 pcs. 0,15 ea.</p>	<p>Some model plane motors get so hot that this magnet must be used: It keeps its magnetisation at temperatures up to 120 degrees Celsius.</p>
<p>Q-05-2.5-02-HN Block magnet 5 x 2,5 x 2 mm Weight: 0,19 g Nickel-plated (Ni-Cu-Ni) Magnetisation: 44H strength: approx. 450 g</p>	<p>Price in EUR</p> <p>20 pcs. 0,24 ea. from 60 pcs. 0,20 ea. from 140 pcs. 0,17 ea. from 360 pcs. 0,15 ea.</p>	<p>This magnet can also be used at temperatures up to 120 degrees Celsius.</p>
<p>Q-05-04-01-G Block magnet 5 x 4 x 1 mm Weight: 0,15 g Gold-plated (Ni-Cu-Ni-Au) Magnetisation: N50 strength: approx. 350 g</p>	<p>Price in EUR</p> <p>20 pcs. 0,25 ea. from 60 pcs. 0,21 ea. from 140 pcs. 0,18 ea. from 360 pcs. 0,16 ea.</p>	<p>The pipsqueak! Desired by model plane enthusiasts, but also designed with your average magnet freak in mind!</p>
<p>Q-05-04-01-N Block magnet 5 x 4 x 1 mm Weight: 0,15 g Nickel-plated (Ni-Cu-Ni) Magnetisation: N50 strength: approx. 350 g</p>	<p>Price in EUR</p> <p>20 pcs. 0,25 ea. from 60 pcs. 0,21 ea. from 140 pcs. 0,18 ea. from 360 pcs. 0,15 ea.</p>	
<p>Q-05-04-1.5-N Block magnet 5 x 4 x 1,5 mm Weight: 0,23 g Nickel-plated (Ni-Cu-Ni) Magnetisation: N48 strength: approx. 500 g</p>	<p>Price in EUR</p> <p>20 pcs. 0,26 ea. from 60 pcs. 0,22 ea. from 140 pcs. 0,19 ea. from 360 pcs. 0,16 ea.</p>	<p>Another special size for model plane enthusiasts.</p>
<p>Q-05-05-01-HN Block magnet 5 x 5 x 1 mm Weight: 0,19 g Nickel-plated (Ni-Cu-Ni) Magnetisation: 44H strength: approx. 350 g</p>	<p>Price in EUR</p> <p>20 pcs. 0,24 ea. from 60 pcs. 0,20 ea. from 140 pcs. 0,18 ea. from 360 pcs. 0,15 ea.</p>	<p>This magnet can be used at temperatures of up to 120 degrees Celsius, as opposed to most of the other magnets on this website, which can be used at a maximum of 80 degrees Celsius. Interesting for model plane builders.</p>
<p>Q-CDM48-G Block magnet 5 x 5 x 1 mm Weight: 0,19 g Gold-plated (Ni-Cu-Ni-Au) Magnetisation: N48 strength: approx. 350 g</p>	<p>Price in EUR</p> <p>20 pcs. 0,28 ea. from 60 pcs. 0,23 ea. from 140 pcs. 0,20 ea. from 360 pcs. 0,18 ea.</p>	<p>We produced this magnet especially for the CD-ROM model airplane engine do-it-yourselfers. Naturally, there are lots of other uses for this small gold-plated magnet. It holds, for example, 2-3 pieces of A4 paper.</p>

<p>Q-CDM48-N Block magnet 5 x 5 x 1 mm Weight: 0,19 g Nickel-plated (Ni-Cu-Ni) Magnetisation: N48 strength: approx. 350 g</p>	<p>Price in EUR</p> <p>20 pcs. 0,28 ea. from 60 pcs. 0,24 ea. from 140 pcs. 0,21 ea. from 360 pcs. 0,18 ea.</p>	<p>This very small block magnet holds, for instance, 2-3 A4 sheets. It looks really good when you use 2 or 4 magnets per sheet. Very discreet with only 1 mm thickness.</p>
<p>Q-CDM50-G Block magnet 5 x 5 x 1,2 mm Weight: 0,23 g Gold-plated (Ni-Cu-Ni-Au) Magnetisation: N50 strength: approx. 450 g</p>	<p>Price in EUR</p> <p>20 pcs. 0,30 ea. from 60 pcs. 0,25 ea. from 140 pcs. 0,22 ea. from 360 pcs. 0,19 ea.</p>	<p>And here we have the ultimate CD-ROM model airplane engine do-it-yourself magnet! Due to high demand, we made this magnet a bit thicker (1,2 mm instead of 1,0 mm) and increased the magnetisation a bit (N50 instead of N48).</p>
<p>Q-CDM50-N Block magnet 5 x 5 x 1,2 mm Weight: 0,23 g Nickel-plated (Ni-Cu-Ni) Magnetisation: N50 strength: approx. 450 g</p>	<p>Price in EUR</p> <p>20 pcs. 0,31 ea. from 60 pcs. 0,26 ea. from 140 pcs. 0,22 ea. from 360 pcs. 0,19 ea.</p>	<p>Small block magnet with especially high magnetisation N50.</p>
<p>Q-05-05-02-G Block magnet 5 x 5 x 2 mm Weight: 0,38 g Gold-plated (Ni-Cu-Ni-Au) Magnetisation: N45 strength: approx. 650 g</p>	<p>Price in EUR</p> <p>10 pcs. 0,33 ea. from 40 pcs. 0,26 ea. from 80 pcs. 0,24 ea. from 160 pcs. 0,21 ea.</p>	<p>Extra strong (N45) and plated with real gold! Ideal for stylish posting of notes. Holds 7 pieces of A4 paper to a metal sheet! The adhesive force on a piece of steel is over 1/2 kg!</p>
<p>Q-05-05-02-N Block magnet 5 x 5 x 2 mm Weight: 0,38 g Nickel-plated (Ni-Cu-Ni) Magnetisation: N45 strength: approx. 650 g</p>	<p>Price in EUR</p> <p>10 pcs. 0,33 ea. from 40 pcs. 0,26 ea. from 80 pcs. 0,23 ea. from 160 pcs. 0,21 ea.</p>	<p>Small block magnet, extra-strong thanks to N45 magnetisation. A classy way to hang up notes - holds 7 A4 sheets on a metal surface!</p>
<p>Q-05-05-03-N52N Block magnet 5 x 5 x 3 mm Weight: 0,57 g Nickel-plated (Ni-Cu-Ni) Magnetisation: N52 strength: approx. 1 kg</p>	<p>Price in EUR</p> <p>20 pcs. 0,30 ea. from 60 pcs. 0,25 ea. from 140 pcs. 0,22 ea. from 360 pcs. 0,19 ea.</p>	<p>Thanks to the extremely strong N52 magnetisation, this small block magnet features an adhesive force of 1 kg.</p>
<p>Q-06-04-02-HN Block magnet 6 x 4 x 2 mm Weight: 0,36 g Nickel-plated (Ni-Cu-Ni) Magnetisation: 44H strength: approx. 640 g</p>	<p>Price in EUR</p> <p>10 pcs. 0,31 ea. from 40 pcs. 0,25 ea. from 80 pcs. 0,22 ea. from 160 pcs. 0,20 ea.</p>	<p>Temperature resistant to 120 degrees Celsius.</p>
<p>Q-06-05-02-HN Block magnet 6 x 5 x 2 mm Weight: 0,46 g Nickel-plated (Ni-Cu-Ni) Magnetisation: 48H strength: approx. 600 g</p>	<p>Price in EUR</p> <p>20 pcs. 0,30 ea. from 60 pcs. 0,25 ea. from 140 pcs. 0,22 ea. from 360 pcs. 0,19 ea.</p>	<p>Temperature resistant to 120 degrees Celsius.</p>
<p>Q-07-06-1.2-G Block magnet 7 x 6 x 1,2 mm Weight: 0,38 g Gold-plated (Ni-Cu-Ni-Au) Magnetisation: N50 strength: approx. 600 g</p>	<p>Price in EUR</p> <p>20 pcs. 0,31 ea. from 60 pcs. 0,26 ea. from 140 pcs. 0,23 ea. from 360 pcs. 0,20 ea.</p>	

<p>Q-07-06-1.2-N Block magnet 7 x 6 x 1,2 mm Weight: 0,38 g Nickel-plated (Ni-Cu-Ni) Magnetisation: N50 strength: approx. 600 g</p>	<p>Price in EUR 20 pcs. 0,31 ea. from 60 pcs. 0,26 ea. from 140 pcs. 0,23 ea. from 360 pcs. 0,20 ea.</p>	
<p>Q-08-04-03-N Block magnet 8 x 4 x 3 mm Weight: 0,73 g Nickel-plated (Ni-Cu-Ni) Magnetisation: N45 strength: approx. 900 g</p>	<p>Price in EUR 20 pcs. 0,31 ea. from 60 pcs. 0,26 ea. from 140 pcs. 0,23 ea. from 360 pcs. 0,20 ea.</p>	
<p>Q-08-05-05-Z Block magnet 8 x 5 x 5 mm Weight: 1,5 g Zinc-plated (Zn) Magnetisation: N45 strength: approx. 1,1 kg</p>	<p>Price in EUR 10 pcs. 0,44 ea. from 40 pcs. 0,36 ea. from 80 pcs. 0,33 ea. from 160 pcs. 0,30 ea.</p>	<p>Contrary to our standard articles, these block magnets are made of zinc and not nickel-coated. Zinc gives them a slightly blue and matt appearance.</p>
<p>Q-08-08-04-N Block magnet 8 x 8 x 4 mm Weight: 1,9 g Nickel-plated (Ni-Cu-Ni) Magnetisation: N45 strength: approx. 1,5 kg</p>	<p>Price in EUR 10 pcs. 0,52 ea. from 40 pcs. 0,43 ea. from 80 pcs. 0,39 ea. from 160 pcs. 0,36 ea.</p>	
<p>Q-10-03-02-HN Block magnet 10 x 3 x 2 mm Weight: 0,46 g Nickel-plated (Ni-Cu-Ni) Magnetisation: 44H strength: approx. 700 g</p>	<p>Price in EUR 10 pcs. 0,33 ea. from 40 pcs. 0,26 ea. from 80 pcs. 0,24 ea. from 160 pcs. 0,21 ea.</p>	<p>Up to 120 degrees Celsius. This magnet is often used by model airplane enthusiasts who construct their own engines. The stronger the magnet, the smaller and lighter the engine can be made.</p>
<p>Q-10-04-01-G Block magnet 10 x 4 x 1 mm Weight: 0,3 g Gold-plated (Ni-Cu-Ni-Au) Magnetisation: N50 strength: approx. 580 g</p>	<p>Price in EUR 20 pcs. 0,30 ea. from 60 pcs. 0,25 ea. from 140 pcs. 0,22 ea. from 360 pcs. 0,19 ea.</p>	
<p>Q-10-04-01-N Block magnet 10 x 4 x 1 mm Weight: 0,3 g Nickel-plated (Ni-Cu-Ni) Magnetisation: N50 strength: approx. 580 g</p>	<p>Price in EUR 20 pcs. 0,30 ea. from 60 pcs. 0,25 ea. from 140 pcs. 0,22 ea. from 360 pcs. 0,19 ea.</p>	
<p>Q-10-04-1.2-G Block magnet 10 x 4 x 1,2 mm Weight: 0,36 g Gold-plated (Ni-Cu-Ni-Au) Magnetisation: N50 strength: approx. 700 g</p>	<p>Price in EUR 20 pcs. 0,32 ea. from 60 pcs. 0,27 ea. from 140 pcs. 0,24 ea. from 360 pcs. 0,21 ea.</p>	
<p>Q-10-04-1.2-N Block magnet 10 x 4 x 1,2 mm Weight: 0,36 g Nickel-plated (Ni-Cu-Ni) Magnetisation: N50 strength: approx. 700 g</p>	<p>Price in EUR 20 pcs. 0,32 ea. from 60 pcs. 0,27 ea. from 140 pcs. 0,24 ea. from 360 pcs. 0,20 ea.</p>	

Q-10-04-1.5-G		Price in EUR	
Block magnet		20 pcs.	0,34 ea.
10 x 4 x 1,5 mm	from	60 pcs.	0,29 ea.
Weight: 0,46 g	from	140 pcs.	0,25 ea.
Gold-plated (Ni-Cu-Ni-Au)	from	360 pcs.	0,22 ea.
Magnetisation: N50			
strength: approx. 900 g			
Q-10-04-1.5-N		Price in EUR	
Block magnet		20 pcs.	0,34 ea.
10 x 4 x 1,5 mm	from	60 pcs.	0,29 ea.
Weight: 0,46 g	from	140 pcs.	0,25 ea.
Nickel-plated (Ni-Cu-Ni)	from	360 pcs.	0,22 ea.
Magnetisation: N50			
strength: approx. 900 g			
Q-10-04-02-G		Price in EUR	
Block magnet 10 x 4 x 2 mm		10 pcs.	0,40 ea.
Weight: 0,61 g	from	40 pcs.	0,33 ea.
Gold-plated (Ni-Cu-Ni-Au)	from	80 pcs.	0,29 ea.
Magnetisation: N50	from	160 pcs.	0,27 ea.
strength: approx. 1,1 kg			
Q-10-04-02-N		Price in EUR	
Block magnet 10 x 4 x 2 mm		20 pcs.	0,33 ea.
Weight: 0,61 g	from	60 pcs.	0,27 ea.
Nickel-plated (Ni-Cu-Ni)	from	140 pcs.	0,24 ea.
Magnetisation: N50	from	360 pcs.	0,21 ea.
strength: approx. 1,1 kg			
Q-10-05-01-G		Price in EUR	
Block magnet 10 x 5 x 1 mm		20 pcs.	0,31 ea.
Weight: 0,38 g	from	60 pcs.	0,26 ea.
Gold-plated (Ni-Cu-Ni-Au)	from	140 pcs.	0,23 ea.
Magnetisation: N50	from	360 pcs.	0,20 ea.
strength: approx. 650 g			
Q-10-05-01-N		Price in EUR	
Block magnet 10 x 5 x 1 mm		20 pcs.	0,31 ea.
Weight: 0,38 g	from	60 pcs.	0,26 ea.
Nickel-plated (Ni-Cu-Ni)	from	140 pcs.	0,23 ea.
Magnetisation: N50	from	360 pcs.	0,20 ea.
strength: approx. 650 g			
Q-10-05-1.2-G		Price in EUR	
Block magnet		20 pcs.	0,34 ea.
10 x 5 x 1,2 mm	from	60 pcs.	0,29 ea.
Weight: 0,46 g	from	140 pcs.	0,25 ea.
Gold-plated (Ni-Cu-Ni-Au)	from	360 pcs.	0,22 ea.
Magnetisation: N50			
strength: approx. 800 g			
Q-10-05-1.2-N		Price in EUR	
Block magnet		20 pcs.	0,33 ea.
10 x 5 x 1,2 mm	from	60 pcs.	0,28 ea.
Weight: 0,46 g	from	140 pcs.	0,25 ea.
Nickel-plated (Ni-Cu-Ni)	from	360 pcs.	0,21 ea.
Magnetisation: N50			
strength: approx. 800 g			
Q-10-05-1.5-G		Price in EUR	
Block magnet		20 pcs.	0,39 ea.
10 x 5 x 1,5 mm	from	60 pcs.	0,33 ea.
Weight: 0,57 g	from	140 pcs.	0,29 ea.
Gold-plated (Ni-Cu-Ni-Au)	from	360 pcs.	0,25 ea.
Magnetisation: N50			
strength: approx. 980 g			

<p>Q-10-05-1.5-N Block magnet 10 x 5 x 1,5 mm Weight: 0,57 g Nickel-plated (Ni-Cu-Ni) Magnetisation: N50 strength: approx. 980 g</p>	<p>Price in EUR 20 pcs. 0,38 ea. from 60 pcs. 0,33 ea. from 140 pcs. 0,29 ea. from 360 pcs. 0,25 ea.</p>	
<p>Q-10-05-02-G Block magnet 10 x 5 x 2 mm Weight: 0,76 g Gold-plated (Ni-Cu-Ni-Au) Magnetisation: N50 strength: approx. 1,2 kg</p>	<p>Price in EUR 10 pcs. 0,44 ea. from 40 pcs. 0,35 ea. from 80 pcs. 0,32 ea. from 160 pcs. 0,29 ea.</p>	
<p>Q-10-05-02-N Block magnet 10 x 5 x 2 mm Weight: 0,76 g Nickel-plated (Ni-Cu-Ni) Magnetisation: N50 strength: approx. 1,2 kg</p>	<p>Price in EUR 10 pcs. 0,42 ea. from 40 pcs. 0,34 ea. from 80 pcs. 0,31 ea. from 160 pcs. 0,28 ea.</p>	
<p>Q-10-05-03-N Block magnet 10 x 5 x 3 mm Weight: 1,1 g Nickel-plated (Ni-Cu-Ni) Magnetisation: N45 strength: approx. 1,5 kg</p>	<p>Price in EUR 10 pcs. 0,42 ea. from 40 pcs. 0,34 ea. from 80 pcs. 0,31 ea. from 160 pcs. 0,28 ea.</p>	
<p>Q-10-06-06-Z Block magnet 10 x 6 x 6 mm Weight: 2,7 g Zinc-plated (Zn) Magnetisation: N45 strength: approx. 2,1 kg</p>	<p>Price in EUR 10 pcs. 0,57 ea. from 40 pcs. 0,48 ea. from 80 pcs. 0,44 ea. from 160 pcs. 0,40 ea.</p>	<p>Contrary to our standard articles, these block magnets are made of zinc and not nickel-coated. Zinc gives them a slightly blue and matt appearance.</p>
<p>Q-10-10-01-N Block magnet 10 x 10 x 1 mm Weight: 0,76 g Nickel-plated (Ni-Cu-Ni) Magnetisation: N42 strength: approx. 600 g</p>	<p>Price in EUR 10 pcs. 0,44 ea. from 40 pcs. 0,35 ea. from 80 pcs. 0,32 ea. from 160 pcs. 0,29 ea.</p>	
<p>Q-10-10-1.2-N52N Block magnet 10 x 10 x 1,2 mm Weight: 0,91 g Nickel-plated (Ni-Cu-Ni) Magnetisation: N52 strength: approx. 1 kg</p>	<p>Price in EUR 10 pcs. 0,49 ea. from 40 pcs. 0,40 ea. from 80 pcs. 0,36 ea. from 160 pcs. 0,32 ea.</p>	<p>Thanks to its extremely strong N52 magnetisation, this very flat block magnet has an adhesive force of 1 kg.</p>
<p>Q-10-10-02-N Block magnet 10 x 10 x 2 mm Weight: 1,5 g Nickel-plated (Ni-Cu-Ni) Magnetisation: N45 strength: approx. 1 kg</p>	<p>Price in EUR 10 pcs. 0,50 ea. from 40 pcs. 0,41 ea. from 80 pcs. 0,37 ea. from 160 pcs. 0,34 ea.</p>	
<p>Q-10-10-03-N Block magnet 10 x 10 x 3 mm Weight: 2,3 g Nickel-plated (Ni-Cu-Ni) Magnetisation: N42 strength: approx. 1,7 kg</p>	<p>Price in EUR 10 pcs. 0,55 ea. from 40 pcs. 0,45 ea. from 80 pcs. 0,41 ea. from 160 pcs. 0,37 ea.</p>	

<p>Q-10-10-04-K Block magnet 10 x 10 x 4 mm Weight: 3 g copper-plated (Ni-Cu) Magnetisation: N40 strength: approx. 2,2 kg</p>	<p>Price in EUR</p> <p>5 pcs. 0,78 ea. from 15 pcs. 0,67 ea. from 40 pcs. 0,59 ea. from 80 pcs. 0,54 ea.</p>	<p>Strong block magnets in trendy copper-colour! These magnets shimmer reddish-brown-golden and are the eye-catcher on glass magnetic boards and magnetic boards.</p>
<p>Q-10-10-04-N Block magnet 10 x 10 x 4 mm Weight: 3 g Nickel-plated (Ni-Cu-Ni) Magnetisation: N40 strength: approx. 2,2 kg</p>	<p>Price in EUR</p> <p>10 pcs. 0,62 ea. from 40 pcs. 0,52 ea. from 80 pcs. 0,47 ea. from 160 pcs. 0,44 ea.</p>	<p>These block magnets have the right size for attaching postcards to a glass magnetic board for instance.</p>
<p>Q-10-10-05-N Block magnet 10 x 10 x 5 mm Weight: 3,8 g Nickel-plated (Ni-Cu-Ni) Magnetisation: N42 strength: approx. 2,8 kg</p>	<p>Price in EUR</p> <p>5 pcs. 0,80 ea. from 15 pcs. 0,69 ea. from 40 pcs. 0,61 ea. from 80 pcs. 0,55 ea.</p>	<p>We couldn't think of any unique comments to make about this magnet. It's simply a good average model.</p>
<p>Q-12-07-02-HN Block magnet 12 x 7 x 2 mm Weight: 1,3 g Nickel-plated (Ni-Cu-Ni) Magnetisation: 44H strength: approx. 1,3 kg</p>	<p>Price in EUR</p> <p>10 pcs. 0,54 ea. from 40 pcs. 0,44 ea. from 80 pcs. 0,40 ea. from 160 pcs. 0,36 ea.</p>	<p>Temperature resistant to 120 degrees Celsius.</p>
<p>Q-12-08-02-N Block magnet 12 x 8 x 2 mm Weight: 1,5 g Nickel-plated (Ni-Cu-Ni) Magnetisation: N50 strength: approx. 1,5 kg</p>	<p>Price in EUR</p> <p>10 pcs. 0,50 ea. from 40 pcs. 0,41 ea. from 80 pcs. 0,37 ea. from 160 pcs. 0,34 ea.</p>	
<p>Q-15-04-04-MN Block magnet 15 x 4 x 4 mm Weight: 1,8 g Nickel-plated (Ni-Cu-Ni) Magnetisation: 45M strength: approx. 1,7 kg</p>	<p>Price in EUR</p> <p>10 pcs. 0,53 ea. from 40 pcs. 0,44 ea. from 80 pcs. 0,40 ea. from 160 pcs. 0,36 ea.</p>	<p>The axis of magnetisation is along the 4 mm axis. Temperature-resistant up to 100 degrees Celsius. The right size for your first attempts with Halbach-Arrays.</p>
<p>Q-15-15-03-N Block magnet 15 x 15 x 3 mm Weight: 5,1 g Nickel-plated (Ni-Cu-Ni) Magnetisation: N45 strength: approx. 3,4 kg</p>	<p>Price in EUR</p> <p>5 pcs. 1,10 ea. from 15 pcs. 0,96 ea. from 40 pcs. 0,85 ea. from 80 pcs. 0,78 ea.</p>	
<p>Q-15-15-08-N Block magnet 15 x 15 x 8 mm Weight: 14 g Nickel-plated (Ni-Cu-Ni) Magnetisation: N42 strength: approx. 7,6 kg</p>	<p>Price in EUR</p> <p>5 pcs. 2,65 ea. from 15 pcs. 2,29 ea. from 40 pcs. 2,02 ea. from 80 pcs. 1,86 ea.</p>	<p>Imagine this: an adhesive force of more than 7 kg in such a small piece. Instead of daily training with dumbbells, just try to pull this magnet away from a steel plate a few times...</p>
<p>Q-18-08-04-Z Block magnet 18 x 8 x 4 mm Weight: 4,4 g Zinc-plated (Zn) Magnetisation: N45 strength: approx. 2,7 kg</p>	<p>Price in EUR</p> <p>5 pcs. 0,87 ea. from 15 pcs. 0,76 ea. from 40 pcs. 0,67 ea. from 80 pcs. 0,62 ea.</p>	<p>Contrary to our standard articles, these block magnets are made of zinc and not nickel-coated. Zinc gives them a slightly blue and matt appearance.</p>

<p>Q-18-15-10-Z Block magnet 18 x 15 x 10 mm Weight: 21 g Zinc-plated (Zn) Magnetisation: N45 strength: approx. 9,8 kg</p>	<p>Price in EUR</p> <p>1 pc. 3,17 ea. from 3 pcs. 2,77 ea. from 10 pcs. 2,41 ea. from 20 pcs. 2,23 ea. from 40 pcs. 2,08 ea.</p>	<p>Contrary to our standard articles, these block magnets are made of zinc and not nickel-coated. Zinc gives them a slightly blue and matt appearance.</p>
<p>Q-18-18-04-Z Block magnet 18 x 18 x 4 mm Weight: 9,8 g Zinc-plated (Zn) Magnetisation: N45 strength: approx. 4,1 kg</p>	<p>Price in EUR</p> <p>5 pcs. 1,53 ea. from 15 pcs. 1,34 ea. from 40 pcs. 1,20 ea. from 80 pcs. 1,12 ea.</p>	<p>Contrary to our standard articles, these block magnets are made of zinc and not nickel-coated. Zinc gives them a slightly blue and matt appearance.</p>
<p>Q-19-13-06-LN Block magnet 19,05 x 12,7 x 6,35 mm Weight: 12 g Nickel-plated (Ni-Cu-Ni) Magnetisation: N42 (Axis 19,05 mm) strength: approx. 4,1 kg</p>	<p>Price in EUR</p> <p>5 pcs. 1,71 ea. from 15 pcs. 1,50 ea. from 40 pcs. 1,34 ea. from 80 pcs. 1,25 ea.</p>	<p>The same size as the Q-19-13-06-N, but magnetised lengthwise. the two magnet poles are located on the two end faces (6 x 13 mm). The adhesive force of this magnet is somewhat smaller due to the smaller adhesive surface but, because of this, they are much easier to hold and easier to separate.</p>
<p>Q-19-13-06-N Block magnet 19,05 x 12,7 x 6,35 mm Weight: 12 g Nickel-plated (Ni-Cu-Ni) Magnetisation: N42 strength: approx. 6,5 kg</p>	<p>Price in EUR</p> <p>5 pcs. 1,65 ea. from 15 pcs. 1,44 ea. from 40 pcs. 1,29 ea. from 80 pcs. 1,20 ea.</p>	<p>A totally great deal! You get a very large magnet for a ludicrously low price. This one is certainly strong enough to give your fingertips a good pinch if you're not careful enough. It holds 40 pieces of A4 (80g/m²) to a metal plate!</p>
<p>Q-20-04-02-N Block magnet 20 x 4 x 2 mm Weight: 1,2 g Nickel-plated (Ni-Cu-Ni) Magnetisation: N45 strength: approx. 1,2 kg</p>	<p>Price in EUR</p> <p>10 pcs. 0,42 ea. from 40 pcs. 0,34 ea. from 80 pcs. 0,31 ea. from 160 pcs. 0,28 ea.</p>	<p>Extra strong (N45) magnets. These magnets are often used by model airplane builders. Heat resistant up to 80 degrees Celsius.</p>
<p>Q-20-04-03-N Block magnet 20 x 4 x 3 mm Weight: 1,8 g Nickel-plated (Ni-Cu-Ni) Magnetisation: N48 strength: approx. 2,4 kg</p>	<p>Price in EUR</p> <p>10 pcs. 0,54 ea. from 40 pcs. 0,44 ea. from 80 pcs. 0,40 ea. from 160 pcs. 0,37 ea.</p>	
<p>Q-20-05-02-HN Block magnet 20 x 5 x 2 mm Weight: 1,5 g Nickel-plated (Ni-Cu-Ni) Magnetisation: 44H strength: approx. 1,5 kg</p>	<p>Price in EUR</p> <p>10 pcs. 0,53 ea. from 40 pcs. 0,44 ea. from 80 pcs. 0,40 ea. from 160 pcs. 0,37 ea.</p>	<p>This is an especially thin and very flat block magnet. It can sustain a very high maximum operation temperature of 120°C (magnetisation 44H).</p>
<p>Q-20-05-05-Z Block magnet 20 x 5 x 5 mm Weight: 3,8 g Zinc-plated (Zn) Magnetisation: N42 strength: approx. 2,5 kg</p>	<p>Price in EUR</p> <p>5 pcs. 0,75 ea. from 15 pcs. 0,65 ea. from 40 pcs. 0,57 ea. from 80 pcs. 0,52 ea.</p>	<p>Contrary to our standard articles, these block magnets are made of zinc and not nickel-coated. Zinc gives them a slightly blue and matt appearance.</p>
<p>Q-20-10-02-N Block magnet 20 x 10 x 2 mm Weight: 3 g Nickel-plated (Ni-Cu-Ni) Magnetisation: N45 strength: approx. 2,1 kg</p>	<p>Price in EUR</p> <p>5 pcs. 0,74 ea. from 15 pcs. 0,64 ea. from 40 pcs. 0,56 ea. from 80 pcs. 0,52 ea.</p>	<p>A very flat block magnet with an adhesive force of about 2 kg. Especially suitable for tight spaces.</p>

<p>Q-20-10-05-N Block magnet 20 x 10 x 5 mm Weight: 7,6 g Nickel-plated (Ni-Cu-Ni) Magnetisation: N42 strength: approx. 3,8 kg</p>	<p>Price in EUR</p> <p>5 pcs. 1,29 ea. from 15 pcs. 1,13 ea. from 40 pcs. 1,00 ea. from 80 pcs. 0,93 ea.</p>	
<p>Q-20-20-03-N Block magnet 20 x 20 x 3 mm Weight: 9,1 g Nickel-plated (Ni-Cu-Ni) Magnetisation: N45 strength: approx. 4,2 kg</p>	<p>Price in EUR</p> <p>5 pcs. 1,47 ea. from 15 pcs. 1,28 ea. from 40 pcs. 1,15 ea. from 80 pcs. 1,06 ea.</p>	<p>Flat, thin magnet. Suitable for permanent installation, for example, with glue. Can also be used to attach two metal objects, for example, metal signs to metal doors or cars, etc. Super strong!</p>
<p>Q-20-20-05-N Block magnet 20 x 20 x 5 mm Weight: 15 g Nickel-plated (Ni-Cu-Ni) Magnetisation: N42 strength: approx. 6 kg</p>	<p>Price in EUR</p> <p>1 pc. 2,52 ea. from 3 pcs. 2,19 ea. from 10 pcs. 1,90 ea. from 20 pcs. 1,76 ea. from 40 pcs. 1,63 ea.</p>	<p>A very flat, square block magnet. Very popular in the areas of metal, machine and plant construction as well as interior fittings.</p>
<p>Q-20-20-10-N Block magnet 20 x 20 x 10 mm Weight: 30 g Nickel-plated (Ni-Cu-Ni) Magnetisation: N42 strength: approx. 12 kg</p>	<p>Price in EUR</p> <p>1 pc. 4,29 ea. from 3 pcs. 3,75 ea. from 10 pcs. 3,28 ea. from 20 pcs. 3,04 ea. from 40 pcs. 2,84 ea.</p>	<p>A magnet for the serious magnetist. Only someone with very strong hands can separate two of these magnets from each other. Our customers lovingly called this one "THE SKIN PINCHER". Not for children or magnet weaklings!</p>
<p>Q-22-8.5-1.4-SHN Block magnet 22 x 8,5 x 1,4 mm Weight: 2 g Nickel-plated (Ni-Cu-Ni) Magnetisation: 35SH strength: approx. 1,3 kg</p>	<p>Price in EUR</p> <p>10 pcs. 0,58 ea. from 40 pcs. 0,48 ea. from 80 pcs. 0,44 ea. from 160 pcs. 0,40 ea.</p>	<p>This is an especially flat and thin block magnet. It is well suited for brushless motors and is therefore popular with model builders. It can sustain a very high maximum operation temperature of 150°C.</p>
<p>Q-25-06-02-SN Block magnet 25 x 6 x 2 mm Weight: 2,3 g Nickel-plated (Ni-Cu-Ni) Magnetisation: 45SH strength: approx. 1,7 kg</p>	<p>Price in EUR</p> <p>5 pcs. 0,90 ea. from 15 pcs. 0,78 ea. from 40 pcs. 0,69 ea. from 80 pcs. 0,63 ea.</p>	<p>This is an especially flat and thin block magnet. It is well suited for brushless motors and is therefore popular with model builders. It can sustain a very high maximum operation temperature of 150°C.</p>
<p>Q-25-08-01-N Block magnet 25 x 8 x 1 mm Weight: 1,5 g Nickel-plated (Ni-Cu-Ni) Magnetisation: N48 strength: approx. 1,1 kg</p>	<p>Price in EUR</p> <p>10 pcs. 0,56 ea. from 40 pcs. 0,46 ea. from 80 pcs. 0,42 ea. from 160 pcs. 0,38 ea.</p>	
<p>Q-25-15-06-N Block magnet 25 x 15 x 6 mm Weight: 17 g Nickel-plated (Ni-Cu-Ni) Magnetisation: N45 strength: approx. 7 kg</p>	<p>Price in EUR</p> <p>1 pc. 2,81 ea. from 3 pcs. 2,45 ea. from 10 pcs. 2,12 ea. from 20 pcs. 1,97 ea. from 40 pcs. 1,83 ea.</p>	
<p>Q-25-25-13-N Block magnet 25,4 x 25,4 x 12,7 mm Weight: 62 g Nickel-plated (Ni-Cu-Ni) Magnetisation: N40 strength: approx. 20 kg</p>	<p>Price in EUR</p> <p>1 pc. 7,32 ea. from 3 pcs. 6,44 ea. from 10 pcs. 5,66 ea. from 20 pcs. 5,28 ea. from 40 pcs. 4,95 ea.</p>	<p>We simply call this one THE GIANT. Very, very powerful. If two of these become stuck together, you'll have a hard time separating them with only your bare hands, and then only with a great deal of effort. Not suitable for children!</p>

<p>Q-30-07-2.5-HE Block magnet 30 x 7 x 2,5 mm Weight: 4 g Epoxy coating (Ni-Cu-Ni-Epoxy) Magnetisation: 38H strength: approx. 2,1 kg</p>	<p>Price in EUR</p> <table> <tr><td>5 pcs.</td><td>1,09 ea.</td></tr> <tr><td>from 15 pcs.</td><td>0,94 ea.</td></tr> <tr><td>from 40 pcs.</td><td>0,83 ea.</td></tr> <tr><td>from 80 pcs.</td><td>0,76 ea.</td></tr> </table>	5 pcs.	1,09 ea.	from 15 pcs.	0,94 ea.	from 40 pcs.	0,83 ea.	from 80 pcs.	0,76 ea.	<p>A flat industrial magnet with a Ni-Cu-Ni base coat and a black epoxy resin cover coating. It can be glued together well with epoxy resin.</p>		
5 pcs.	1,09 ea.											
from 15 pcs.	0,94 ea.											
from 40 pcs.	0,83 ea.											
from 80 pcs.	0,76 ea.											
<p>Q-30-10-05-N Block magnet 30 x 10 x 5 mm Weight: 11 g Nickel-plated (Ni-Cu-Ni) Magnetisation: N42 strength: approx. 6,5 kg</p>	<p>Price in EUR</p> <table> <tr><td>5 pcs.</td><td>1,62 ea.</td></tr> <tr><td>from 15 pcs.</td><td>1,42 ea.</td></tr> <tr><td>from 40 pcs.</td><td>1,27 ea.</td></tr> <tr><td>from 80 pcs.</td><td>1,17 ea.</td></tr> </table>	5 pcs.	1,62 ea.	from 15 pcs.	1,42 ea.	from 40 pcs.	1,27 ea.	from 80 pcs.	1,17 ea.			
5 pcs.	1,62 ea.											
from 15 pcs.	1,42 ea.											
from 40 pcs.	1,27 ea.											
from 80 pcs.	1,17 ea.											
<p>Q-30-10-10-Z Block magnet 30 x 10 x 10 mm Weight: 23 g Zinc-plated (Zn) Magnetisation: N40 strength: approx. 8,8 kg</p>	<p>Price in EUR</p> <table> <tr><td>1 pc.</td><td>3,16 ea.</td></tr> <tr><td>from 3 pcs.</td><td>2,75 ea.</td></tr> <tr><td>from 10 pcs.</td><td>2,40 ea.</td></tr> <tr><td>from 20 pcs.</td><td>2,22 ea.</td></tr> <tr><td>from 40 pcs.</td><td>2,07 ea.</td></tr> </table>	1 pc.	3,16 ea.	from 3 pcs.	2,75 ea.	from 10 pcs.	2,40 ea.	from 20 pcs.	2,22 ea.	from 40 pcs.	2,07 ea.	<p>Contrary to our standard articles, these block magnets are made of zinc and not nickel-coated. Zinc gives them a slightly blue and matt appearance.</p>
1 pc.	3,16 ea.											
from 3 pcs.	2,75 ea.											
from 10 pcs.	2,40 ea.											
from 20 pcs.	2,22 ea.											
from 40 pcs.	2,07 ea.											
<p>Q-30-12-12-Z Block magnet 30 x 12 x 12 mm Weight: 33 g Zinc-plated (Zn) Magnetisation: N52 strength: approx. 9,4 kg</p>	<p>Price in EUR</p> <table> <tr><td>1 pc.</td><td>5,20 ea.</td></tr> <tr><td>from 3 pcs.</td><td>4,57 ea.</td></tr> <tr><td>from 10 pcs.</td><td>4,00 ea.</td></tr> <tr><td>from 20 pcs.</td><td>3,73 ea.</td></tr> <tr><td>from 40 pcs.</td><td>3,48 ea.</td></tr> </table>	1 pc.	5,20 ea.	from 3 pcs.	4,57 ea.	from 10 pcs.	4,00 ea.	from 20 pcs.	3,73 ea.	from 40 pcs.	3,48 ea.	<p>Contrary to our standard articles, these block magnets are made of zinc and not nickel-coated. Zinc gives them a slightly blue and matt appearance.</p>
1 pc.	5,20 ea.											
from 3 pcs.	4,57 ea.											
from 10 pcs.	4,00 ea.											
from 20 pcs.	3,73 ea.											
from 40 pcs.	3,48 ea.											
<p>Q-30-15-06-Z Block magnet 30 x 15 x 6 mm Weight: 21 g Zinc-plated (Zn) Magnetisation: 42SH strength: approx. 8,8 kg</p>	<p>Price in EUR</p> <table> <tr><td>1 pc.</td><td>3,77 ea.</td></tr> <tr><td>from 3 pcs.</td><td>3,30 ea.</td></tr> <tr><td>from 10 pcs.</td><td>2,88 ea.</td></tr> <tr><td>from 20 pcs.</td><td>2,67 ea.</td></tr> <tr><td>from 40 pcs.</td><td>2,49 ea.</td></tr> </table>	1 pc.	3,77 ea.	from 3 pcs.	3,30 ea.	from 10 pcs.	2,88 ea.	from 20 pcs.	2,67 ea.	from 40 pcs.	2,49 ea.	<p>Contrary to our standard articles, these block magnets are made of zinc and not nickel-coated. Zinc gives them a slightly blue and matt appearance.</p>
1 pc.	3,77 ea.											
from 3 pcs.	3,30 ea.											
from 10 pcs.	2,88 ea.											
from 20 pcs.	2,67 ea.											
from 40 pcs.	2,49 ea.											
<p>Q-30-30-15-N Block magnet 30 x 30 x 15 mm Weight: 100 g Nickel-plated (Ni-Cu-Ni) Magnetisation: N45 strength: approx. 35 kg</p>	<p>Price in EUR</p> <table> <tr><td>1 pc.</td><td>12,55 ea.</td></tr> <tr><td>from 3 pcs.</td><td>11,11 ea.</td></tr> <tr><td>from 10 pcs.</td><td>9,83 ea.</td></tr> <tr><td>from 20 pcs.</td><td>9,21 ea.</td></tr> <tr><td>from 40 pcs.</td><td>8,65 ea.</td></tr> </table>	1 pc.	12,55 ea.	from 3 pcs.	11,11 ea.	from 10 pcs.	9,83 ea.	from 20 pcs.	9,21 ea.	from 40 pcs.	8,65 ea.	
1 pc.	12,55 ea.											
from 3 pcs.	11,11 ea.											
from 10 pcs.	9,83 ea.											
from 20 pcs.	9,21 ea.											
from 40 pcs.	8,65 ea.											
<p>Q-40-10-05-N Block magnet 40 x 10 x 5 mm Weight: 15 g Nickel-plated (Ni-Cu-Ni) Magnetisation: N42 strength: approx. 9,5 kg</p>	<p>Price in EUR</p> <table> <tr><td>1 pc.</td><td>2,51 ea.</td></tr> <tr><td>from 3 pcs.</td><td>2,18 ea.</td></tr> <tr><td>from 10 pcs.</td><td>1,89 ea.</td></tr> <tr><td>from 20 pcs.</td><td>1,75 ea.</td></tr> <tr><td>from 40 pcs.</td><td>1,62 ea.</td></tr> </table>	1 pc.	2,51 ea.	from 3 pcs.	2,18 ea.	from 10 pcs.	1,89 ea.	from 20 pcs.	1,75 ea.	from 40 pcs.	1,62 ea.	<p>A slim, but very strong block magnet. Very popular in the areas of interior fittings, machine construction and cabinetmaking.</p>
1 pc.	2,51 ea.											
from 3 pcs.	2,18 ea.											
from 10 pcs.	1,89 ea.											
from 20 pcs.	1,75 ea.											
from 40 pcs.	1,62 ea.											
<p>Q-40-10-10-N Block magnet 40 x 10 x 10 mm Weight: 30 g Nickel-plated (Ni-Cu-Ni) Magnetisation: N42 strength: approx. 15 kg</p>	<p>Price in EUR</p> <table> <tr><td>1 pc.</td><td>4,49 ea.</td></tr> <tr><td>from 3 pcs.</td><td>3,91 ea.</td></tr> <tr><td>from 10 pcs.</td><td>3,40 ea.</td></tr> <tr><td>from 20 pcs.</td><td>3,15 ea.</td></tr> <tr><td>from 40 pcs.</td><td>2,92 ea.</td></tr> </table>	1 pc.	4,49 ea.	from 3 pcs.	3,91 ea.	from 10 pcs.	3,40 ea.	from 20 pcs.	3,15 ea.	from 40 pcs.	2,92 ea.	<p>A very slim block magnet with an adhesive force of impressive 15 kg. Our customers build it into lamps or wood/metal furniture.</p>
1 pc.	4,49 ea.											
from 3 pcs.	3,91 ea.											
from 10 pcs.	3,40 ea.											
from 20 pcs.	3,15 ea.											
from 40 pcs.	2,92 ea.											
<p>Q-40-15-05-N Block magnet 40 x 15 x 5 mm Weight: 23 g Nickel-plated (Ni-Cu-Ni) Magnetisation: N40 strength: approx. 8 kg</p>	<p>Price in EUR</p> <table> <tr><td>1 pc.</td><td>3,35 ea.</td></tr> <tr><td>from 3 pcs.</td><td>2,91 ea.</td></tr> <tr><td>from 10 pcs.</td><td>2,52 ea.</td></tr> <tr><td>from 20 pcs.</td><td>2,33 ea.</td></tr> <tr><td>from 40 pcs.</td><td>2,16 ea.</td></tr> </table>	1 pc.	3,35 ea.	from 3 pcs.	2,91 ea.	from 10 pcs.	2,52 ea.	from 20 pcs.	2,33 ea.	from 40 pcs.	2,16 ea.	
1 pc.	3,35 ea.											
from 3 pcs.	2,91 ea.											
from 10 pcs.	2,52 ea.											
from 20 pcs.	2,33 ea.											
from 40 pcs.	2,16 ea.											

<p>Q-40-18-05-N Block magnet 40 x 18 x 5 mm Weight: 27 g Nickel-plated (Ni-Cu-Ni) Magnetisation: N35 strength: approx. 8 kg</p>	<p>Price in EUR</p> <p>1 pc. 3,60 ea. from 3 pcs. 3,15 ea. from 10 pcs. 2,74 ea. from 20 pcs. 2,54 ea. from 40 pcs. 2,37 ea.</p>	
<p>Q-40-20-05-N Block magnet 40 x 20 x 5 mm Weight: 30 g Nickel-plated (Ni-Cu-Ni) Magnetisation: N42 strength: approx. 14 kg</p>	<p>Price in EUR</p> <p>1 pc. 4,52 ea. from 3 pcs. 3,94 ea. from 10 pcs. 3,42 ea. from 20 pcs. 3,17 ea. from 40 pcs. 2,94 ea.</p>	
<p>Q-40-20-10-N Block magnet 40 x 20 x 10 mm Weight: 61 g Nickel-plated (Ni-Cu-Ni) Magnetisation: N42 strength: approx. 25 kg</p>	<p>Price in EUR</p> <p>1 pc. 7,30 ea. from 3 pcs. 6,43 ea. from 10 pcs. 5,65 ea. from 20 pcs. 5,27 ea. from 40 pcs. 4,94 ea.</p>	<p>Neodymium block magnet with an adhesive force of 25 kg. Very popular with our customers in machine building and plant construction.</p>
<p>Q-40-40-20-N Block magnet 40 x 40 x 20 mm Weight: 240 g Nickel-plated (Ni-Cu-Ni) Magnetisation: N42 strength: approx. 60 kg</p>	<p>Price in EUR</p> <p>1 pc. 26,06 ea. from 3 pcs. 23,27 ea. from 10 pcs. 20,78 ea. from 20 pcs. 19,57 ea. from 40 pcs. 18,50 ea.</p>	<p>You'd like to do more than just comfortably hang up your sledgehammer, but you're not quite ready for the DEATH MAGNET? Then perhaps this is the right magnet for you: THE COLOSSUS!</p>
<p>Q-46-30-10-N Block magnet 46 x 30 x 10 mm Weight: 100 g Nickel-plated (Ni-Cu-Ni) Magnetisation: N40 strength: approx. 29 kg</p>	<p>Price in EUR</p> <p>1 pc. 11,91 ea. from 3 pcs. 10,48 ea. from 10 pcs. 9,21 ea. from 20 pcs. 8,59 ea. from 40 pcs. 8,04 ea.</p>	
<p>Q-50-15-15-N Block magnet 50 x 15 x 15 mm Weight: 86 g Nickel-plated (Ni-Cu-Ni) Magnetisation: N48 strength: approx. 33 kg</p>	<p>Price in EUR</p> <p>1 pc. 11,16 ea. from 3 pcs. 9,87 ea. from 10 pcs. 8,72 ea. from 20 pcs. 8,16 ea. from 40 pcs. 7,66 ea.</p>	
<p>Q-50-25-10-LN Block magnet 50 x 25 x 10 mm Weight: 95 g Nickel-plated (Ni-Cu-Ni) Magnetisation: N40 (Axis 50 mm) strength: approx. 12 kg</p>	<p>Price in EUR</p> <p>1 pc. 11,61 ea. from 3 pcs. 10,20 ea. from 10 pcs. 8,94 ea. from 20 pcs. 8,32 ea. from 40 pcs. 7,78 ea.</p>	<p>This magnet is magnetised lengthwise, meaning north and south pole are located on both of the smallest surfaces.</p>
<p>Q-50-50-12.5-N Block magnet 50 x 50 x 12,5 mm Weight: 240 g Nickel-plated (Ni-Cu-Ni) Magnetisation: N35 strength: approx. 47 kg</p>	<p>Price in EUR</p> <p>1 pc. 23,46 ea. from 3 pcs. 20,63 ea. from 10 pcs. 18,11 ea. from 20 pcs. 16,88 ea.</p>	<p>A flat block magnet with 50 x 50 x 12,5 mm dimensions.</p>
<p>Q-51-51-25-N Block magnet 50,8 x 50,8 x 25,4 mm Weight: 500 g Nickel-plated (Ni-Cu-Ni) Magnetisation: N40 strength: approx. 100 kg</p>	<p>Price in EUR</p> <p>1 pc. 43,33 ea. from 3 pcs. 38,47 ea. from 10 pcs. 34,13 ea.</p>	<p>We call this magnet THE DEATH MAGNET. I have no idea what you can reasonably do with this magnet - it is simply too intense for most applications. BE CAREFUL!!!</p>

<p>Q-60-30-15-N Block magnet 60 x 30 x 15 mm Weight: 210 g Nickel-plated (Ni-Cu-Ni) Magnetisation: N40 strength: approx. 56 kg</p>	<p>Price in EUR 1 pc. 21,58 ea. from 3 pcs. 19,11 ea. from 10 pcs. 16,90 ea. from 20 pcs. 15,83 ea. from 40 pcs. 14,88 ea.</p>	<p>With an adhesive force of over 50 kg, this block magnet is one of our strongest magnets. Its adhesive force bridges several centimetres of distance, e.g. through a thick book.</p>
<p>Q-70-70-30-N Block magnet 70 x 70 x 30 mm Weight: 1,1 kg Nickel-plated (Ni-Cu-Ni) Magnetisation: N40 strength: approx. 150 kg</p>	<p>Price in EUR 1 pc. 83,84 ea. from 3 pcs. 75,64 ea. from 10 pcs. 68,32 ea. from 20 pcs. 64,76 ea.</p>	<p>After the MONOLITH, the GOLIATH is the second strongest magnet in our assortment. Due to its high adhesive force, the GOLIATH is a very dangerous magnet and not suitable for magnet novices. Please follow the enclosed safety tips.</p>
<p>Q-111-89-20-E Block magnet 110,6 x 89 x 19,5 mm Weight: 1,5 kg Epoxy coating (Ni-Cu-Ni-Epoxy) Magnetisation: N45 strength: approx. 200 kg</p>	<p>Price in EUR 1 pc. 158,43 ea. from 3 pcs. 150,34 ea. from 10 pcs. 143,10 ea. from 20 pcs. 139,59 ea. from 40 pcs. 136,48 ea.</p>	<p>The MONOLITH is the strongest magnet we ever carried in our supermagnete assortment. Due to its high adhesive force, the MONOLITH is a very dangerous magnet and not suitable for magnet novices. It is imperative that you carefully review the enclosed safety tips.</p>

Cube magnets neodymium

All cube magnets have their north and south pole on two opposing surfaces.

<p>W-01-N Cube magnet 1 mm Weight: 0,0076 g Nickel-plated (Ni-Cu-Ni) Magnetisation: N45 strength: approx. 37 g</p>	<p>Price in EUR 20 pcs. 0,21 ea. from 60 pcs. 0,17 ea. from 140 pcs. 0,15 ea. from 360 pcs. 0,13 ea.</p>	<p>They don't come much smaller than this! It's hard to believe, but this mini-magnet has the strength to pin a little note to the wall.</p>
<p>W-03-N Cube magnet 3 mm Weight: 0,21 g Nickel-plated (Ni-Cu-Ni) Magnetisation: N45 strength: approx. 290 g</p>	<p>Price in EUR 20 pcs. 0,21 ea. from 60 pcs. 0,18 ea. from 140 pcs. 0,16 ea. from 360 pcs. 0,13 ea.</p>	
<p>W-04-N Cube magnet 4 mm Weight: 0,49 g Nickel-plated (Ni-Cu-Ni) Magnetisation: N42 strength: approx. 500 g</p>	<p>Price in EUR 20 pcs. 0,31 ea. from 40 pcs. 0,25 ea. from 80 pcs. 0,22 ea. from 160 pcs. 0,20 ea.</p>	
<p>W-05-G Cube magnet 5 mm Weight: 0,95 g Gold-plated (Ni-Cu-Ni-Au) Magnetisation: N42 strength: approx. 1,1 kg</p>	<p>Price in EUR 10 pcs. 0,44 ea. from 40 pcs. 0,36 ea. from 80 pcs. 0,33 ea. from 160 pcs. 0,30 ea.</p>	<p>Same cube as the W-05-N, but plated with real gold. Looks even finer.</p>
<p>W-05-N Cube magnet 5 mm Weight: 0,95 g Nickel-plated (Ni-Cu-Ni) Magnetisation: N42 strength: approx. 1,1 kg</p>	<p>Price in EUR 10 pcs. 0,37 ea. from 40 pcs. 0,30 ea. from 80 pcs. 0,27 ea. from 160 pcs. 0,25 ea.</p>	<p>A small cube magnet with 5 mm edge length. Its adhesive force of 1 kg is astounding for such a small magnet. A perfect and extremely discreet fridge or whiteboard magnet - one of our top sellers for good reason.</p>
<p>W-05-N50-G Cube magnet 5 mm Weight: 0,95 g Gold-plated (Ni-Cu-Ni-Au) Magnetisation: N50 strength: approx. 1,2 kg</p>	<p>Price in EUR 10 pcs. 0,48 ea. from 40 pcs. 0,39 ea. from 80 pcs. 0,36 ea. from 160 pcs. 0,33 ea.</p>	<p>Same article as W-05-G, but with the strongest possible magnetisation. Primarily interesting for model engine enthusiasts. For everyday jobs (hanging-up notes and photos, etc.), you'd do better with the cheaper W-05-G.</p>
<p>W-05-N50-N Cube magnet 5 mm Weight: 0,95 g Nickel-plated (Ni-Cu-Ni) Magnetisation: N50 strength: approx. 1,2 kg</p>	<p>Price in EUR 10 pcs. 0,48 ea. from 40 pcs. 0,39 ea. from 80 pcs. 0,36 ea. from 160 pcs. 0,33 ea.</p>	<p>Identical article to W-05-N, but with the highest magnetisation (N50). Most interesting for builders of model motors. For day to day use (to hang up notes and photos), the cheaper W-05-N is a better fit.</p>
<p>W-06-N Cube magnet 6 mm Weight: 1,6 g Nickel-plated (Ni-Cu-Ni) Magnetisation: N42 strength: approx. 1,3 kg</p>	<p>Price in EUR 5 pcs. 0,53 ea. from 15 pcs. 0,45 ea. from 40 pcs. 0,40 ea. from 80 pcs. 0,36 ea.</p>	<p>These cube magnets can hold small notes on a magnetic glass board, on a whiteboard several layers of paper.</p>

<p>W-07-K Cube magnet 7 mm Weight: 2,6 g copper-plated (Ni-Cu) Magnetisation: N42 strength: approx. 1,6 kg Colour: Copper</p>	<p>Price in EUR</p> <p>5 pcs. 0,67 ea. from 15 pcs. 0,58 ea. from 40 pcs. 0,50 ea. from 80 pcs. 0,46 ea.</p>	<p>Strong cube magnets in trendy copper-colour! These magnets shimmer reddish-brown-golden and are the eye-catcher on glass magnetic boards and magnetic boards.</p>
<p>W-07-N Cube magnet 7 mm Weight: 2,6 g Nickel-plated (Ni-Cu-Ni) Magnetisation: N42 strength: approx. 1,6 kg</p>	<p>Price in EUR</p> <p>5 pcs. 0,67 ea. from 15 pcs. 0,58 ea. from 40 pcs. 0,50 ea. from 80 pcs. 0,46 ea.</p>	<p>Super magnets that can hold it together. They have a proven track record as newspaper holder and bicycle clamp.</p>
<p>W-10-N Cube magnet 10 mm Weight: 7,6 g Nickel-plated (Ni-Cu-Ni) Magnetisation: N42 strength: approx. 3,8 kg Colour: Silver-coloured</p>	<p>Price in EUR</p> <p>5 pcs. 1,40 ea. from 15 pcs. 1,22 ea. from 40 pcs. 1,09 ea. from 80 pcs. 1,00 ea.</p>	<p>Cube-shaped magnets are somewhat unusual. These are strong enough to attract each other through the thickness of a hand. It takes a bit of determination to separate two of these magnets from each other.</p>
<p>W-12-N Cube magnet 12 mm Weight: 13 g Nickel-plated (Ni-Cu-Ni) Magnetisation: N48 strength: approx. 6,3 kg Colour: Silver-coloured</p>	<p>Price in EUR</p> <p>5 pcs. 2,04 ea. from 15 pcs. 1,79 ea. from 40 pcs. 1,60 ea. from 80 pcs. 1,49 ea.</p>	<p>A fat, strong cube magnet with an adhesive force of 6 kg. Two of these cubes can only be separated with a lot of effort.</p>

Sphere magnets made of neodymium

Please note: Due to the danger of swallowing, magnetic spheres are not suitable as toys for children and should be kept out of reach of small children. If they swallow several small magnets, they can accumulate in the intestines and cause life-threatening injuries.

<p>K-03-C Sphere magnet Ø 3 mm Weight: 0,11 g Chrome-plated (Ni-Cu-Ni-Cr) Magnetisation: N42 strength: approx. 130 g</p>	<p>Price in EUR</p> <p>20 pcs. 0,41 ea. from 60 pcs. 0,35 ea. from 140 pcs. 0,31 ea. from 360 pcs. 0,27 ea.</p>	<p>Unleash your creativity! With the small magnetic spheres you can always make new creations with little effort. Please let your friends also experiment with them.</p>
<p>K-05-C Sphere magnet Ø 5 mm Weight: 0,5 g Chrome-plated (Ni-Cu-Ni-Cr) Magnetisation: N42 strength: approx. 360 g</p>	<p>Price in EUR</p> <p>10 pcs. 0,52 ea. from 40 pcs. 0,43 ea. from 80 pcs. 0,39 ea. from 160 pcs. 0,36 ea.</p>	<p>Sphere magnets with 5 mm diameter.</p>
<p>K-05-N Sphere magnet Ø 5 mm Weight: 0,5 g Nickel-plated (Ni-Cu-Ni) Magnetisation: N35 strength: approx. 300 g</p>	<p>Price in EUR</p> <p>20 pcs. 0,17 ea. from 60 pcs. 0,15 ea. from 140 pcs. 0,14 ea. from 360 pcs. 0,13 ea.</p>	<p>Nickel-coated small sphere magnets for endless combining and experimenting. Available in units of 10. ATTENTION: Not suitable for children under 14!</p>
<p>K-06-C Sphere magnet Ø 6 mm Weight: 0,86 g Chrome-plated (Ni-Cu-Ni-Cr) Magnetisation: N38 strength: approx. 470 g</p>	<p>Price in EUR</p> <p>20 pcs. 0,51 ea. from 60 pcs. 0,45 ea. from 140 pcs. 0,40 ea. from 360 pcs. 0,36 ea.</p>	<p>Magnet spheres with a diameter of 6 mm.</p>
<p>K-08-C Sphere magnet Ø 8 mm Weight: 2 g Chrome-plated (Ni-Cu-Ni-Cr) Magnetisation: N38 strength: approx. 850 g</p>	<p>Price in EUR</p> <p>10 pcs. 0,89 ea. from 40 pcs. 0,76 ea. from 80 pcs. 0,71 ea. from 160 pcs. 0,66 ea.</p>	<p>Everyone's Favourite Magnet! This 8 mm magnetic sphere is chrome-plated and perfect for experimenting and combining with other magnets. Once you've held them in your hands, you won't want to put them down.</p>
<p>K-10-C Sphere magnet Ø 10 mm Weight: 4 g Chrome-plated (Ni-Cu-Ni-Cr) Magnetisation: N40 strength: approx. 1,4 kg</p>	<p>Price in EUR</p> <p>10 pcs. 1,11 ea. from 40 pcs. 0,97 ea. from 80 pcs. 0,91 ea. from 160 pcs. 0,86 ea.</p>	<p>Extra fat magnet spheres! 10 mm diameter and, naturally, super strong. For the advanced magnet connoisseur.</p>
<p>K-13-C Sphere magnet Ø 12,7 mm Weight: 8,2 g Chrome-plated (Ni-Cu-Ni-Cr) Magnetisation: N42 strength: approx. 2,4 kg</p>	<p>Price in EUR</p> <p>1 pc. 2,27 ea. from 3 pcs. 1,99 ea. from 10 pcs. 1,75 ea. from 20 pcs. 1,63 ea. from 40 pcs. 1,53 ea.</p>	<p>Ideal to combine with our steel balls, which are exactly the same size.</p>
<p>K-19-C Sphere magnet Ø 19 mm Weight: 27 g Chrome-plated (Ni-Cu-Ni-Cr) Magnetisation: N38 strength: approx. 4,9 kg</p>	<p>Price in EUR</p> <p>5 pcs. 4,05 ea. from 15 pcs. 3,70 ea. from 40 pcs. 3,44 ea. from 80 pcs. 3,28 ea.</p>	<p>Real monster-spheres! I know adults who were not able to separate these magnets from each other. These should be handled with care and are definitely not suitable for children! (No joke!)</p>

<p>K-26-C Sphere magnet Ø 26 mm Weight: 70 g Chrome-plated (Ni-Cu-Ni-Cr) Magnetisation: N38 strength: approx. 9,1 kg</p>	<p>Price in EUR</p> <p>1 pc. 13,39 ea. from 3 pcs. 12,30 ea. from 10 pcs. 11,33 ea. from 20 pcs. 10,86 ea. from 40 pcs. 10,44 ea.</p>	<p>We are definitely in the area of the absurd here. None of the women I know can separate these two magnetic spheres - except for this one alpinist...</p>
<p>K-30-C Sphere magnet Ø 30 mm Weight: 110 g Chrome-plated (Ni-Cu-Ni-Cr) Magnetisation: N40 strength: approx. 13 kg</p>	<p>Price in EUR</p> <p>1 pc. 18,19 ea. from 3 pcs. 17,06 ea. from 10 pcs. 16,05 ea. from 20 pcs. 15,56 ea. from 40 pcs. 15,13 ea.</p>	<p>A diameter of 30 mm is actually an absurd size for sphere magnets - each sphere has an adhesive force of over 13 kg! The surface coating will not last forever, since the point-shaped contact areas are exposed to enormous force.</p>
<p>K-40-C Sphere magnet Ø 40 mm Weight: 250 g Chrome-plated (Ni-Cu-Ni-Cr) Magnetisation: N40 strength: approx. 23 kg</p>	<p>Price in EUR</p> <p>1 pc. 46,83 ea. from 3 pcs. 43,66 ea. from 10 pcs. 40,82 ea. from 20 pcs. 39,44 ea. from 40 pcs. 38,22 ea.</p>	<p>A single sphere has an adhesive force of over 23 kg! It is practically impossible to separate two of these magnets by hand - you would need the help of a table edge.</p>

Ring magnets neodymium

Most ring magnets have their north and south poles on the even circular surfaces (axial magnetisation). The few exceptions that are diametrically magnetised are especially marked.

<p>R-06-02-02-G Ring magnet Ø 6/2 mm, height 2 mm Weight: 0,38 g Gold-plated (Ni-Cu-Ni-Au) Magnetisation: N45 strength: approx. 760 g</p>	<p>Price in EUR 10 pcs. 0,34 ea. from 40 pcs. 0,27 ea. from 80 pcs. 0,24 ea. from 160 pcs. 0,22 ea.</p>	<p>Real gold-plated little ring. Very strong. What do women say about this one? "Adorable!"</p>
<p>R-06-02-02-N Ring magnet Ø 6/2 mm, height 2 mm Weight: 0,38 g Nickel-plated (Ni-Cu-Ni) Magnetisation: N45 strength: approx. 760 g</p>	<p>Price in EUR 10 pcs. 0,34 ea. from 40 pcs. 0,27 ea. from 80 pcs. 0,25 ea. from 160 pcs. 0,22 ea.</p>	<p>A real small ring. Very strong. What do you say? "Cute!"</p>
<p>R-08-02-06-N Ring magnet Ø 8/2 mm, height 6 mm Weight: 2,1 g Nickel-plated (Ni-Cu-Ni) Magnetisation: N50 strength: approx. 2,4 kg</p>	<p>Price in EUR 10 pcs. 0,63 ea. from 40 pcs. 0,52 ea. from 80 pcs. 0,48 ea. from 160 pcs. 0,44 ea.</p>	
<p>R-09-07-11-N Ring magnet Ø 9/7 mm, height 11 mm Weight: 2,1 g Nickel-plated (Ni-Cu-Ni) Magnetisation: N50 strength: approx. 1,5 kg</p>	<p>Price in EUR 5 pcs. 1,65 ea. from 15 pcs. 1,45 ea. from 40 pcs. 1,31 ea. from 80 pcs. 1,21 ea.</p>	
<p>R-10-04-05-G Ring magnet Ø 10/4 mm, height 5 mm Weight: 2,5 g Gold-plated (Ni-Cu-Ni-Au) Magnetisation: N42 strength: approx. 2,5 kg</p>	<p>Price in EUR 5 pcs. 0,93 ea. from 15 pcs. 0,80 ea. from 40 pcs. 0,71 ea. from 80 pcs. 0,65 ea.</p>	<p>Gold-plated magnet ring. As with almost all of our ring magnets, the poles are located on the flat circular area.</p>
<p>R-10-04-05-N Ring magnet Ø 10/4 mm, height 5 mm Weight: 2,5 g Nickel-plated (Ni-Cu-Ni) Magnetisation: N42 strength: approx. 2,5 kg</p>	<p>Price in EUR 10 pcs. 0,57 ea. from 40 pcs. 0,48 ea. from 80 pcs. 0,44 ea. from 160 pcs. 0,40 ea.</p>	<p>Same article as R-10-04-05-G, but nickel-plated instead of gold-plated.</p>
<p>R-10-04-10-N Ring magnet Ø 10/4 mm, height 10 mm Weight: 5 g Nickel-plated (Ni-Cu-Ni) Magnetisation: N42 strength: approx. 3,1 kg</p>	<p>Price in EUR 5 pcs. 1,10 ea. from 15 pcs. 0,96 ea. from 40 pcs. 0,85 ea. from 80 pcs. 0,79 ea.</p>	
<p>R-10-04-15-N Ring magnet Ø 10/4 mm, height 15 mm Weight: 7,5 g Nickel-plated (Ni-Cu-Ni) Magnetisation: N42 strength: approx. 3,3 kg</p>	<p>Price in EUR 5 pcs. 1,42 ea. from 15 pcs. 1,25 ea. from 40 pcs. 1,12 ea. from 80 pcs. 1,04 ea.</p>	

<p>R-10-05-05-DN Ring magnet Ø 10/5 mm, height 5 mm Weight: 2,2 g Nickel-plated (Ni-Cu-Ni) Magnetisation: N45 strength: approx. 700 g</p>	<p>Price in EUR</p> <p>5 pcs. 0,92 ea. from 15 pcs. 0,80 ea. from 40 pcs. 0,71 ea. from 80 pcs. 0,66 ea.</p>	<p>Diametrically magnetised!</p>
<p>R-10-07-03-DN Ring magnet Ø 10/7 mm, height 3 mm Weight: 0,91 g Nickel-plated (Ni-Cu-Ni) Magnetisation: N45 strength: approx. 400 g</p>	<p>Price in EUR</p> <p>5 pcs. 0,72 ea. from 15 pcs. 0,62 ea. from 40 pcs. 0,55 ea. from 80 pcs. 0,50 ea.</p>	<p>Diametrically magnetised!</p>
<p>R-12-05-12-N Ring magnet Ø 12/5 mm, height 12 mm Weight: 8,5 g Nickel-plated (Ni-Cu-Ni) Magnetisation: N42 strength: approx. 4,4 kg</p>	<p>Price in EUR</p> <p>5 pcs. 1,75 ea. from 15 pcs. 1,54 ea. from 40 pcs. 1,39 ea. from 80 pcs. 1,30 ea.</p>	
<p>R-12-09-1.5-N Ring magnet Ø 12/9 mm, height 1,5 mm Weight: 0,56 g Nickel-plated (Ni-Cu-Ni) Magnetisation: N45 strength: approx. 1,5 kg</p>	<p>Price in EUR</p> <p>10 pcs. 0,42 ea. from 40 pcs. 0,35 ea. from 80 pcs. 0,32 ea. from 160 pcs. 0,29 ea.</p>	
<p>R-15-06-06-N Ring magnet Ø 15/6 mm, height 6 mm Weight: 6,8 g Nickel-plated (Ni-Cu-Ni) Magnetisation: N42 strength: approx. 5,1 kg</p>	<p>Price in EUR</p> <p>5 pcs. 1,21 ea. from 15 pcs. 1,06 ea. from 40 pcs. 0,94 ea. from 80 pcs. 0,87 ea.</p>	<p>A medium-sized ring - An animation to demonstrate repulsion can be found among the pictures in the article description in our web shop.</p>
<p>R-19-09-06-N Ring magnet Ø 19,1/9,5 mm, height 6,4 mm Weight: 10 g Nickel-plated (Ni-Cu-Ni) Magnetisation: N42 strength: approx. 7,5 kg</p>	<p>Price in EUR</p> <p>5 pcs. 1,89 ea. from 15 pcs. 1,66 ea. from 40 pcs. 1,50 ea. from 80 pcs. 1,39 ea.</p>	<p>Really big ring magnet. Two ring magnets reject each other vertically by approx. 5 cm.</p>
<p>R-20-04-05-N Ring magnet Ø 20/4,2 mm, height 5 mm Weight: 11 g Nickel-plated (Ni-Cu-Ni) Magnetisation: N45 strength: approx. 7,2 kg</p>	<p>Price in EUR</p> <p>1 pc. 2,38 ea. from 3 pcs. 2,07 ea. from 10 pcs. 1,79 ea. from 20 pcs. 1,66 ea. from 40 pcs. 1,54 ea.</p>	
<p>R-25-04-05-N Ring magnet Ø 25/4,2 mm, height 5 mm Weight: 18 g Nickel-plated (Ni-Cu-Ni) Magnetisation: N45 strength: approx. 9,4 kg</p>	<p>Price in EUR</p> <p>1 pc. 3,36 ea. from 3 pcs. 2,94 ea. from 10 pcs. 2,56 ea. from 20 pcs. 2,37 ea. from 40 pcs. 2,21 ea.</p>	
<p>R-27-16-05-N Ring magnet Ø 26,75/16 mm, height 5 mm Weight: 14 g Nickel-plated (Ni-Cu-Ni) Magnetisation: N42 strength: approx. 11 kg</p>	<p>Price in EUR</p> <p>1 pc. 2,81 ea. from 3 pcs. 2,45 ea. from 10 pcs. 2,13 ea. from 20 pcs. 1,97 ea. from 40 pcs. 1,83 ea.</p>	

R-40-23-06-N

Ring magnet Ø 40/23 mm,
height 6 mm
Weight: 38 g
Nickel-plated (Ni-Cu-Ni)
Magnetisation: N42
strength: approx. 21 kg

Price in EUR

	1 pc.	7,07 ea.
from	3 pcs.	6,17 ea.
from	10 pcs.	5,36 ea.
from	20 pcs.	4,97 ea.
from	40 pcs.	4,63 ea.

This is the largest of our "normal" ring magnets. With an adhesive force of over 20 kg it is a fierce magnet - please handle with care.

R-60-06-30-N

Ring magnet Ø 60/6 mm,
height 30 mm
Weight: 640 g
Nickel-plated (Ni-Cu-Ni)
Magnetisation: N45
strength: approx. 120 kg

Price in EUR

	1 pc.	68,05 ea.
from	3 pcs.	61,35 ea.
from	10 pcs.	55,36 ea.
from	20 pcs.	52,45 ea.

Giant ring (actually closer to a disc with a drill hole), that is suitable for tying with a piece of cord. You can use this to fish your bicycle (and who knows what else) out of the canal.

Cone magnets neodymium

These neodymium magnets are cone-shaped. On the small circular area the magnetic field lines are bundled, which gives the magnets a very high adhesive force. They are perfectly suitable for whiteboards, magnetic boards, etc. The stump holds notes securely and it can be easily removed by pulling it off to the side. If the base is attached to a metal surface, however, it is hard to remove.

<p>CN-10-05-04-N Cone magnet Ø 10/5 mm, height 4 mm Weight: 1,4 g Nickel-plated (Ni-Cu-Ni) Magnetisation: N45 strength: approx. 1,2 kg Sticks to whiteboard: 13 A4 sheets Colour: Silver-coloured</p>	<p>Price in EUR 5 pcs. 0,69 ea. from 15 pcs. 0,61 ea. from 40 pcs. 0,55 ea. from 120 pcs. 0,49 ea.</p>	<p>These cone magnets are neodymium magnets with special features: The magnetic flux lines are bundled on the small circular surface, and therefore the magnets possess a high adhesive force. The north pole is located on the small circular surface.</p>
<p>CN-15-08-06-N Cone magnet Ø 15/8 mm, height 6 mm Weight: 4,9 g Nickel-plated (Ni-Cu-Ni) Magnetisation: N42 strength: approx. 3,1 kg Sticks to whiteboard: 20 A4 sheets Colour: Silver-coloured</p>	<p>Price in EUR 5 pcs. 1,41 ea. from 15 pcs. 1,26 ea. from 40 pcs. 1,14 ea. from 120 pcs. 1,04 ea.</p>	<p>These cone magnets are neodymium magnets with special features: The magnetic flux lines are bundled on the small circular surface, and therefore the magnets possess a high adhesive force. The north pole is located on the small circular surface.</p>
<p>CN-20-10-08-N Cone magnet Ø 20/10 mm, height 8 mm Weight: 11 g Nickel-plated (Ni-Cu-Ni) Magnetisation: N38 strength: approx. 4,9 kg Sticks to whiteboard: 25 A4 sheets Colour: Silver-coloured</p>	<p>Price in EUR 1 pc. 2,83 ea. from 3 pcs. 2,53 ea. from 10 pcs. 2,25 ea. from 40 pcs. 1,99 ea. from 80 pcs. 1,87 ea.</p>	<p>These cone magnets are neodymium magnets with special features: The magnetic flux lines are bundled on the small circular surface, and therefore the magnets possess a high adhesive force. The north pole is located on the small circular surface.</p>
<p>CN-25-13-10-N Cone magnet Ø 25/13 mm, height 10 mm Weight: 22 g Nickel-plated (Ni-Cu-Ni) Magnetisation: N38 strength: approx. 8,6 kg Sticks to whiteboard: 35 A4 sheets Colour: Silver-coloured</p>	<p>Price in EUR 1 pc. 4,93 ea. from 3 pcs. 4,42 ea. from 10 pcs. 3,96 ea. from 40 pcs. 3,53 ea. from 80 pcs. 3,34 ea.</p>	<p>These cone magnets are neodymium magnets with special features: The magnetic flux lines are bundled on the small circular surface, and therefore the magnets possess a high adhesive force. The north pole is located on the small circular surface.</p>

Waterproof neodymium magnets: rustproof & with scratch protection

The neodymium magnets in this group are entirely coated by a layer of rubber, which provides the following advantages:

Scratch protection: Delicate surfaces, such as whiteboards or magnetic glass boards, are well protected

Waterproof: These magnets are rustproof and can be used outdoors as long as the rubber coating stays intact

Friction: The rubber coat substantially increases the magnetic adhesive force in shear direction

Due to the rubber coating the maximum adhesive force of these magnets is slightly lower, however, compared to similar-sized neodymium magnets without coating.

<p>M-BLOCK-01 Block magnets with plastic cover water-proof, 5 per set in different colours Weight: 89 g/set strength: approx. 5,5 kg</p>	<p>Price in EUR</p> <p>1 set 18,82/set from 3 sets 17,40/set from 10 sets 16,14/set from 20 sets 15,53/set from 40 sets 14,99/set</p>	<p>Strong neodymium block magnets with a colourful plastic coating. The plastic covers the magnets completely, so they can be used in wet surroundings without rusting. The plastic also protects fragile surfaces such as whiteboards from scratches.</p>
<p>M-DISC-01 Disc magnets with plastic cover Ø 9,4 mm water-proof, 10 per set in different colours Weight: 33 g/set strength: approx. 1 kg</p>	<p>Price in EUR</p> <p>1 set 11,09/set from 3 sets 10,20/set from 10 sets 9,41/set from 20 sets 9,03/set from 40 sets 8,69/set</p>	<p>Strong neodymium disc magnets with a colourful plastic coating. The plastic covers the magnets completely, so they can be used in wet surroundings without rusting. The plastic also protects fragile surfaces such as whiteboards from scratches.</p>
<p>M-DISC-02 Disc magnets with plastic cover Ø 13,4 mm water-proof, 5 per set in different colours Weight: 23 g/set strength: approx. 1,7 kg</p>	<p>Price in EUR</p> <p>1 set 7,20/set from 3 sets 6,59/set from 10 sets 6,05/set from 20 sets 5,79/set from 40 sets 5,55/set</p>	<p>Strong neodymium disc magnets with a colourful plastic coating. The plastic covers the magnets completely, so they can be used in wet surroundings without rusting. The plastic also protects fragile surfaces such as whiteboards from scratches.</p>
<p>S-15-03-R Disc magnet rubber coated Ø 16,8 mm, height 4,4 mm water-proof, neodymium, N45 Weight: 4 g strength: approx. 1,5 kg</p>	<p>Price in EUR</p> <p>5 pcs. 1,38 ea. from 15 pcs. 1,22 ea. from 40 pcs. 1,09 ea. from 80 pcs. 1,02 ea.</p>	<p>These neodymium magnets feature a rubber coating and are suitable for permanent outdoor or underwater use.</p>
<p>S-15-08-R Disc magnet rubber coated Ø 16,8 mm, height 9,4 mm water-proof, neodymium, N42 Weight: 11 g strength: approx. 3,7 kg</p>	<p>Price in EUR</p> <p>1 pc. 2,61 ea. from 3 pcs. 2,29 ea. from 10 pcs. 2,00 ea. from 20 pcs. 1,86 ea. from 40 pcs. 1,74 ea.</p>	<p>These neodymium magnets feature a rubber coating and are suitable for permanent outdoor or underwater use.</p>
<p>S-20-05-R Disc magnet rubber coated Ø 22 mm, height 6,4 mm water-proof, neodymium, N42 Weight: 12 g strength: approx. 3,9 kg</p>	<p>Price in EUR</p> <p>1 pc. 2,94 ea. from 3 pcs. 2,58 ea. from 10 pcs. 2,26 ea. from 20 pcs. 2,11 ea. from 40 pcs. 1,97 ea.</p>	<p>These neodymium magnets feature a rubber coating and are suitable for permanent outdoor or underwater use.</p>
<p>S-20-10-R Disc magnet rubber coated Ø 22 mm, height 11,4 mm water-proof, neodymium, N42 Weight: 24 g strength: approx. 7,1 kg</p>	<p>Price in EUR</p> <p>1 pc. 4,38 ea. from 3 pcs. 3,87 ea. from 10 pcs. 3,41 ea. from 20 pcs. 3,19 ea. from 40 pcs. 2,99 ea.</p>	<p>These neodymium magnets feature a rubber coating and are suitable for permanent outdoor or underwater use.</p>

Self-adhesive neodymium magnets

Flat neodymium magnets with self-adhesive backside are perfectly suitable as latches for paper and cardboard items, name tags and other arts and crafts purposes.

<p>S-06-0.75-STIC Disc magnet self-adhesive Ø 6 mm, height 0,75 mm Weight: 0,16 g Nickel-plated (Ni-Cu-Ni) Magnetisation: N35 strength: approx. 230 g Adhesive: 3M, No. 467MP Shelf life adhesive: 12 months (approx.) Path additional document: 3M_200MP_Adhesive_Family_TDS_2017.pdf Label additional document: Adhesive data sheet</p>	<p>Price in EUR 20 pcs. 0,26 ea. from 60 pcs. 0,22 ea. from 140 pcs. 0,20 ea. from 360 pcs. 0,17 ea.</p>	<p>The convenient solution if you want to glue on a disc magnet. This very flat small disc magnet (6 mm diameter, 0,75 mm thin) has a strong self-adhesive foam side.</p>
<p>S-08-0.75-STIC Disc magnet self-adhesive Ø 8 mm, height 0,75 mm Weight: 0,29 g Nickel-plated (Ni-Cu-Ni) Magnetisation: N35 strength: approx. 320 g Adhesive: 3M, No. 467MP Shelf life adhesive: 12 months (approx.) Path additional document: 3M_200MP_Adhesive_Family_TDS_2017.pdf Label additional document: Adhesive data sheet</p>	<p>Price in EUR 20 pcs. 0,25 ea. from 60 pcs. 0,21 ea. from 140 pcs. 0,19 ea. from 360 pcs. 0,16 ea.</p>	<p>No more annoying holes in your designer clothing: S-08-0.75-STIC holds name tags elegantly and without safety pins.</p>
<p>S-9.5-0.75-STIC Disc magnet self-adhesive Ø 9,5 mm, height 0,75 mm Weight: 0,4 g Nickel-plated (Ni-Cu-Ni) Magnetisation: N35 strength: approx. 380 g Adhesive: 3M, No. 467MP Shelf life adhesive: 12 months (approx.) Path additional document: 3M_200MP_Adhesive_Family_TDS_2017.pdf Label additional document: Adhesive data sheet</p>	<p>Price in EUR 20 pcs. 0,26 ea. from 60 pcs. 0,22 ea. from 140 pcs. 0,19 ea. from 360 pcs. 0,17 ea.</p>	<p>A convenient solution if you would like to glue on a disc magnet. This is a very flat disc magnet (9.5 mm diameter, 0.75 mm thin) with a self-adhesive side.</p>
<p>S-10-0.6-STIC Disc magnet self-adhesive Ø 10 mm, height 0,6 mm Weight: 0,36 g Nickel-plated (Ni-Cu-Ni) Magnetisation: N35 strength: approx. 310 g Adhesive: 3M, No. 467MP Shelf life adhesive: 12 months (approx.) Path additional document: 3M_200MP_Adhesive_Family_TDS_2017.pdf Label additional document: Adhesive data sheet</p>	<p>Price in EUR 20 pcs. 0,26 ea. from 60 pcs. 0,22 ea. from 140 pcs. 0,20 ea. from 360 pcs. 0,18 ea.</p>	<p>A convenient solution if you would like to glue on a disc magnet. This is a very flat disc magnet (10 mm diameter, 0.6 mm thin) with a self-adhesive side.</p>
<p>S-10-01-STIC Disc magnet self-adhesive Ø 10 mm, height 1 mm Weight: 0,6 g Nickel-plated (Ni-Cu-Ni) Magnetisation: N35 strength: approx. 540 g Adhesive: 3M, No. 467MP Shelf life adhesive: 12 months (approx.) Path additional document: 3M_200MP_Adhesive_Family_TDS_2017.pdf Label additional document: Adhesive data sheet</p>	<p>Price in EUR 20 pcs. 0,28 ea. from 60 pcs. 0,24 ea. from 140 pcs. 0,21 ea. from 360 pcs. 0,19 ea.</p>	<p>The convenient solution if you want to glue on the S-10-01-N. This is a flat disc magnet with a self-adhesive side. Just peel off the film and glue it on. One sales unit contains 10 magnetic pairs that attract each other.</p>
<p>S-12-02-FOAM Disc magnet self-adhesive Ø 12 mm, height 2 mm Weight: 1,7 g Nickel-plated (Ni-Cu-Ni) Magnetisation: N35 strength: approx. 1,3 kg Adhesive: 3M, No. 4920, 0,40 mm Shelf life adhesive: 18 months (approx.) Path additional document: data_sheet_3m_4920.pdf Label additional document: Adhesive data sheet</p>	<p>Price in EUR 20 pcs. 0,39 ea. from 60 pcs. 0,34 ea. from 140 pcs. 0,31 ea. from 360 pcs. 0,28 ea.</p>	<p>The convenient solution if you want to glue on the magnet S-12-02-N. This is a flat disc magnet with a self-adhesive side made of cushion foam. Just remove the foil and glue it on. One sales unit contains 10 magnetic pairs.</p>
<p>S-13-01-STIC Disc magnet self-adhesive Ø 13 mm, height 1 mm Weight: 1 g Nickel-plated (Ni-Cu-Ni) Magnetisation: N35 strength: approx. 710 g Adhesive: 3M, No. 467MP Shelf life adhesive: 12 months (approx.) Path additional document: 3M_200MP_Adhesive_Family_TDS_2017.pdf Label additional document: Adhesive data sheet</p>	<p>Price in EUR 20 pcs. 0,35 ea. from 60 pcs. 0,30 ea. from 140 pcs. 0,27 ea. from 360 pcs. 0,25 ea.</p>	<p>The convenient solution if you want to glue on a disc magnet. This very flat disc magnet (13 mm diameter, 1 mm thin) has a strong self-adhesive foam side.</p>
<p>S-15-01-STIC Disc magnet self-adhesive Ø 15 mm, height 1 mm Weight: 1,3 g Nickel-plated (Ni-Cu-Ni) Magnetisation: N35 strength: approx. 820 g Adhesive: 3M, No. 467MP Shelf life adhesive: 12 months (approx.) Path additional document: 3M_200MP_Adhesive_Family_TDS_2017.pdf Label additional document: Adhesive data sheet</p>	<p>Price in EUR 20 pcs. 0,39 ea. from 60 pcs. 0,34 ea. from 140 pcs. 0,31 ea. from 360 pcs. 0,28 ea.</p>	<p>The convenient solution if you want to glue on a disc magnet. It is a very flat disc magnet (15 mm diameter, 1 mm thin) with a self-adhesive side.</p>

<p>S-15-02-FOAM Disc magnet self-adhesive Ø 15 mm, height 2 mm Weight: 2,7 g Nickel-plated (Ni-Cu-Ni) Magnetisation: N35 strength: approx. 1,7 kg Adhesive: 3M, No. 4920, 0,40 mm Shelf life adhesive: 18 months (approx.) Path additional document: data_sheet_3m_4920.pdf Label additional document: Adhesive data sheet</p>	<p>Price in EUR</p> <p>10 pcs. 0,59 ea.</p> <p>from 40 pcs. 0,50 ea.</p> <p>from 80 pcs. 0,46 ea.</p> <p>from 160 pcs. 0,42 ea.</p>	<p>The convenient solution if you want to glue on the disc magnet S-15-02-N. This flat disc magnet (15 mm diameter, 2 mm thin) has a strong self-adhesive foam side.</p>
<p>S-18-01-STIC Disc magnet self-adhesive Ø 18 mm, height 1 mm Weight: 1,9 g Nickel-plated (Ni-Cu-Ni) Magnetisation: N35 strength: approx. 980 g Adhesive: 3M, No. 467MP Shelf life adhesive: 12 months (approx.) Path additional document: 3M_200MP_Adhesive_Family_TDS_2017.pdf Label additional document: Adhesive data sheet</p>	<p>Price in EUR</p> <p>10 pcs. 0,54 ea.</p> <p>from 40 pcs. 0,45 ea.</p> <p>from 80 pcs. 0,42 ea.</p> <p>from 160 pcs. 0,39 ea.</p>	<p>The convenient solution if you want to glue on a disc magnet. This very flat disc magnet (18 mm diameter, 1 mm thin) has a strong self-adhesive foam side.</p>
<p>S-18-02-FOAM Disc magnet self-adhesive Ø 18 mm, height 2 mm Weight: 3,9 g Nickel-plated (Ni-Cu-Ni) Magnetisation: N35 strength: approx. 2 kg Adhesive: 3M, No. 4920, 0,40 mm Shelf life adhesive: 18 months (approx.) Path additional document: data_sheet_3m_4920.pdf Label additional document: Adhesive data sheet</p>	<p>Price in EUR</p> <p>10 pcs. 0,71 ea.</p> <p>from 40 pcs. 0,60 ea.</p> <p>from 80 pcs. 0,55 ea.</p> <p>from 160 pcs. 0,51 ea.</p>	<p>The convenient solution if you want to glue on a disc magnet. This flat disc magnet (18 mm diameter, 2 mm thin) has a strong self-adhesive foam side.</p>
<p>S-20-01-STIC Disc magnet self-adhesive Ø 20 mm, height 1 mm Weight: 2,4 g Nickel-plated (Ni-Cu-Ni) Magnetisation: N35 strength: approx. 1,1 kg Adhesive: 3M, No. 467MP Shelf life adhesive: 12 months (approx.) Path additional document: 3M_200MP_Adhesive_Family_TDS_2017.pdf Label additional document: Adhesive data sheet</p>	<p>Price in EUR</p> <p>10 pcs. 0,53 ea.</p> <p>from 40 pcs. 0,45 ea.</p> <p>from 80 pcs. 0,42 ea.</p> <p>from 160 pcs. 0,39 ea.</p>	<p>The convenient solution if you want to glue on a disc magnet. It is a very flat disc magnet (15 mm diameter, 1 mm thin) with a self-adhesive side.</p>
<p>S-20-02-FOAM Disc magnet self-adhesive Ø 20 mm, height 2 mm Weight: 4,8 g Nickel-plated (Ni-Cu-Ni) Magnetisation: N35 strength: approx. 2,3 kg Adhesive: 3M, No. 4920, 0,40 mm Shelf life adhesive: 18 months (approx.) Path additional document: data_sheet_3m_4920.pdf Label additional document: Adhesive data sheet</p>	<p>Price in EUR</p> <p>10 pcs. 0,84 ea.</p> <p>from 40 pcs. 0,73 ea.</p> <p>from 80 pcs. 0,68 ea.</p> <p>from 160 pcs. 0,64 ea.</p>	<p>The convenient solution if you want to glue on the magnet S-20-02-N. This is a flat disc magnet with a self-adhesive side made of cushion foam. Just remove the foil and glue it on. One sales unit contains 5 magnet pairs.</p>
<p>S-22-02-FOAM Disc magnet self-adhesive Ø 22 mm, height 2 mm Weight: 5,8 g Nickel-plated (Ni-Cu-Ni) Magnetisation: N35 strength: approx. 2,5 kg Adhesive: 3M, No. 4920, 0,40 mm Shelf life adhesive: 18 months (approx.) Path additional document: data_sheet_3m_4920.pdf Label additional document: Adhesive data sheet</p>	<p>Price in EUR</p> <p>10 pcs. 0,93 ea.</p> <p>from 40 pcs. 0,79 ea.</p> <p>from 80 pcs. 0,74 ea.</p> <p>from 160 pcs. 0,69 ea.</p>	<p>This very flat disc magnet (22 mm diameter, 2 mm thick) has a very strong self-adhesive foam side and a remarkable adhesive force of approx. 2,5 kg.</p>
<p>S-25-02-FOAM Disc magnet self-adhesive Ø 25 mm, height 2 mm Weight: 7,5 g Nickel-plated (Ni-Cu-Ni) Magnetisation: N35 strength: approx. 2,9 kg Adhesive: 3M, No. 4920, 0,40 mm Shelf life adhesive: 18 months (approx.) Path additional document: data_sheet_3m_4920.pdf Label additional document: Adhesive data sheet</p>	<p>Price in EUR</p> <p>10 pcs. 1,38 ea.</p> <p>from 40 pcs. 1,20 ea.</p> <p>from 80 pcs. 1,12 ea.</p> <p>from 160 pcs. 1,06 ea.</p>	<p>This very flat disc magnet (25 mm diameter, 2 mm thick) has a very strong self-adhesive foam side and a remarkable adhesive force of about 3 kg.</p>
<p>Q-10-05-01-STIC Block magnet self-adhesive 10 x 5 x 1 mm Weight: 0,38 g Nickel-plated (Ni-Cu-Ni) Magnetisation: N35 strength: approx. 500 g Adhesive: 3M, No. 467MP Shelf life adhesive: 12 months (approx.) Path additional document: 3M_200MP_Adhesive_Family_TDS_2017.pdf Label additional document: Adhesive data sheet</p>	<p>Price in EUR</p> <p>40 pcs. 0,23 ea.</p> <p>from 120 pcs. 0,20 ea.</p> <p>from 280 pcs. 0,18 ea.</p> <p>from 640 pcs. 0,16 ea.</p>	<p>A convenient solution if you want to glue on a block magnet. This is a very flat block magnet (10 mm long, 5 mm wide, 1 mm thin) with a self-adhesive side.</p>
<p>Q-10-10-01-STIC Block magnet self-adhesive 10 x 10 x 1 mm Weight: 0,76 g Nickel-plated (Ni-Cu-Ni) Magnetisation: N35 strength: approx. 500 g Adhesive: 3M, No. 467MP Shelf life adhesive: 12 months (approx.) Path additional document: 3M_200MP_Adhesive_Family_TDS_2017.pdf Label additional document: Adhesive data sheet</p>	<p>Price in EUR</p> <p>20 pcs. 0,30 ea.</p> <p>from 60 pcs. 0,26 ea.</p> <p>from 140 pcs. 0,23 ea.</p> <p>from 360 pcs. 0,20 ea.</p>	<p>The convenient solution if you want to glue on the block magnet. This is a very flat block magnet (10 mm long, 10 mm wide, 1 mm thin) with a self-adhesive side.</p>

<p>Q-15-08-01-STIC Block magnet self-adhesive 15 x 8 x 1 mm Weight: 0,91 g Nickel-plated (Ni-Cu-Ni) Magnetisation: N35 strength: approx. 600 g Adhesive: 3M, No. 467MP Shelf life adhesive: 12 months (approx.) Path additional document: 3M_200MP_Adhesive_Family_TDS_2017.pdf Label additional document: Adhesive data sheet</p>	<p>Price in EUR 20 pcs. 0,35 ea. from 60 pcs. 0,30 ea. from 140 pcs. 0,27 ea. from 360 pcs. 0,24 ea.</p>	<p>The convenient solution if you would like to glue on block magnets. This is a very flat block magnet (15 mm long, 8 mm wide, 1 mm thin) with a self-adhesive side.</p>
<p>Q-20-10-01-STIC Block magnet self-adhesive 20 x 10 x 1 mm Weight: 1,5 g Nickel-plated (Ni-Cu-Ni) Magnetisation: N35 strength: approx. 800 g Adhesive: 3M, No. 467MP Shelf life adhesive: 12 months (approx.) Path additional document: 3M_200MP_Adhesive_Family_TDS_2017.pdf Label additional document: Adhesive data sheet</p>	<p>Price in EUR 20 pcs. 0,41 ea. from 60 pcs. 0,36 ea. from 140 pcs. 0,33 ea. from 360 pcs. 0,30 ea.</p>	<p>A convenient solution if you want to glue on a block magnet. This is a very flat block magnet (20 mm long, 10 mm wide, 1 mm thin) with a self-adhesive side.</p>
<p>Q-20-20-01-STIC Block magnet self-adhesive 20 x 20 x 1 mm Weight: 3 g Nickel-plated (Ni-Cu-Ni) Magnetisation: N35 strength: approx. 1,1 kg Adhesive: 3M, No. 467MP Shelf life adhesive: 12 months (approx.) Path additional document: 3M_200MP_Adhesive_Family_TDS_2017.pdf Label additional document: Adhesive data sheet</p>	<p>Price in EUR 20 pcs. 0,58 ea. from 40 pcs. 0,50 ea. from 80 pcs. 0,47 ea. from 160 pcs. 0,44 ea.</p>	<p>The convenient solution if you want to glue on a block magnet. This is a very flat block magnet (20 mm long, 20 mm wide, 1 mm thin) with a self-adhesive side.</p>
<p>Q-25-12-01-STIC Block magnet self-adhesive 25 x 12 x 1 mm Weight: 2,3 g Nickel-plated (Ni-Cu-Ni) Magnetisation: N35 strength: approx. 1 kg Adhesive: 3M, No. 467MP Shelf life adhesive: 12 months (approx.) Path additional document: 3M_200MP_Adhesive_Family_TDS_2017.pdf Label additional document: Adhesive data sheet</p>	<p>Price in EUR 10 pcs. 0,75 ea. from 40 pcs. 0,62 ea. from 80 pcs. 0,57 ea. from 160 pcs. 0,52 ea.</p>	<p>The convenient solution if you want to glue on a block magnet. This is a very flat block magnet (25 mm long, 12 mm wide, 1 mm thin) with a self-adhesive side.</p>
<p>Q-30-10-01-STIC Block magnet self-adhesive 30 x 10 x 1 mm Weight: 2,3 g Nickel-plated (Ni-Cu-Ni) Magnetisation: N35 strength: approx. 1 kg Adhesive: 3M, No. 467MP Shelf life adhesive: 12 months (approx.) Path additional document: 3M_200MP_Adhesive_Family_TDS_2017.pdf Label additional document: Adhesive data sheet</p>	<p>Price in EUR 20 pcs. 0,57 ea. from 60 pcs. 0,50 ea. from 140 pcs. 0,46 ea. from 360 pcs. 0,42 ea.</p>	<p>A convenient solution if you would like to glue on a block magnet. This is a very flat block magnet (30 mm long, 10 mm wide, 1 mm thin) with a self-adhesive side.</p>
<p>Q-40-12-01-STIC Block magnet self-adhesive 40 x 12 x 1 mm Weight: 3,6 g Nickel-plated (Ni-Cu-Ni) Magnetisation: N35 strength: approx. 1,2 kg Adhesive: 3M, No. 467MP Shelf life adhesive: 12 months (approx.) Path additional document: 3M_200MP_Adhesive_Family_TDS_2017.pdf Label additional document: Adhesive data sheet</p>	<p>Price in EUR 20 pcs. 0,83 ea. from 60 pcs. 0,74 ea. from 140 pcs. 0,68 ea. from 360 pcs. 0,62 ea.</p>	<p>A convenient solution if you would like to glue on a block magnet. This is a very flat block magnet (40 mm long, 12 mm wide, 1 mm thin) with a self-adhesive side.</p>

Magnet sets

Please note: Due to the dangers of swallowing magnets, the magnets in this set are not suitable as toys for small children and must be kept out of their reach! If two or more magnets are swallowed they can get caught in the intestines and cause life-threatening injuries.

Z-10 Macho set magnet set case with 40 super magnets Weight: 1,4 kg/set	Price in EUR 1 set 59,99/set	For people who aren't easily impressed, we now have the supermagnete macho set! 10 large and 30 small super magnets in one tool case.
Z-04 Set 114 set with 114 small magnets Weight: 59 g/set	Price in EUR 1 set 17,02/set from 3 sets 15,44/set from 10 sets 14,03/set from 20 sets 13,31/set from 40 sets 12,72/set	Set with 114 super magnets! You'll receive 30 pcs Q-05-05-02-G, 30 pcs. S-06-02-N, 30 pcs. R-06-02-02-G, 12 pcs. W-05-N, 12 pcs. W-05-G. Purchased singly, these 114 magnets cost almost twice the price - a hit price!

Sew-in magnets neodymium

Flat neodymium disc magnets, shrink-wrapped in sturdy plastic foil, to sew into clothing. Thanks to the plastic covering, the magnets are waterproof and rustproof and can be washed and used outdoors and in wet surroundings.

<p>M-SEW-01 Sew-in magnets 12 x 2 mm angular water-proof with square PVC cover Weight: 2 g strength: approx. 1,2 kg</p>	<p>Price in EUR 20 pcs. 0,55 ea. from 60 pcs. 0,52 ea. from 140 pcs. 0,51 ea. from 360 pcs. 0,48 ea.</p>	<p>These are disc magnets (12 x 2 mm) with an adhesive force of approximately 1 kg, shrink-wrapped into a square PVC cover. They can be sewn into clothing or used in wet surroundings without rusting.</p>
<p>M-SEW-02 Sew-in magnets 12 x 2 mm round water-proof with circular PVC cover Weight: 2 g strength: approx. 1,2 kg</p>	<p>Price in EUR 20 pcs. 0,55 ea. from 60 pcs. 0,52 ea. from 140 pcs. 0,51 ea. from 360 pcs. 0,48 ea.</p>	<p>These are disc magnets (12 x 2 mm) with an adhesive force of approximately 1 kg, shrink-wrapped into a round PVC cover. They can be sewn into clothing or used in wet surroundings without rusting.</p>
<p>M-SEW-03 Sew-in magnets 18 x 2 mm angular water-proof with square PVC cover Weight: 4 g strength: approx. 1,9 kg</p>	<p>Price in EUR 10 pcs. 0,82 ea. from 40 pcs. 0,77 ea. from 80 pcs. 0,75 ea. from 160 pcs. 0,73 ea.</p>	<p>These are disc magnets (18 x 2 mm) with an adhesive force of almost 2 kg, shrink-wrapped into a square PVC cover. They can be sewn into clothing or used in wet surroundings without rusting.</p>
<p>M-SEW-04 Sew-in magnets 18 x 2 mm round water-proof with circular PVC cover Weight: 4 g strength: approx. 1,9 kg</p>	<p>Price in EUR 10 pcs. 0,81 ea. from 40 pcs. 0,76 ea. from 80 pcs. 0,74 ea. from 160 pcs. 0,72 ea.</p>	<p>These are disc magnets (18 x 2 mm) with an adhesive force of almost 2 kg, shrink-wrapped into a round PVC cover. They can be sewn into clothing or used in wet surroundings without rusting.</p>

Screw-on neodymium magnets

Flat countersunk neodymium disc and block magnets with one or two boreholes can be fastened with a countersunk head screw. They are only 4 mm thick and therefore very discreet for hanging up signs, tools, etc. Screw-on magnets are very popular in the areas of kitchen installations, booth and store construction, signage technology, furniture construction, etc.

CS-S-15-04-N Disc magnet Ø 15 mm, height 4 mm with countersunk borehole N35, nickel-plated Weight: 4 g strength: approx. 3 kg		Price in EUR	Diameter D: 15 mm
		5 pcs. 0,89 ea.	Height H: 4 mm
	from	15 pcs. 0,78 ea.	Borehole d1: 4,5 mm
	from	40 pcs. 0,69 ea.	Borehole d2: 9,46 mm
	from	80 pcs. 0,64 ea.	Countersink t: 2,48 mm
			Tolerance: +/- 0,1 mm
CS-S-18-04-N Disc magnet Ø 18 mm, height 4 mm with countersunk borehole N35, nickel-plated Weight: 6,3 g strength: approx. 4 kg		Price in EUR	Diameter D: 18 mm
		5 pcs. 1,21 ea.	Height H: 4 mm
	from	15 pcs. 1,05 ea.	Borehole d1: 4,5 mm
	from	40 pcs. 0,93 ea.	Borehole d2: 9,46 mm
	from	80 pcs. 0,86 ea.	Countersink t: 2,48 mm
			Tolerance: +/- 0,1 mm
CS-S-23-04-N Disc magnet Ø 23 mm, height 4 mm with countersunk borehole N35, nickel-plated Weight: 11 g strength: approx. 6,5 kg		Price in EUR	Diameter D: 23 mm
		5 pcs. 1,59 ea.	Height H: 4 mm
	from	15 pcs. 1,40 ea.	Borehole d1: 4,5 mm
	from	40 pcs. 1,26 ea.	Borehole d2: 9,46 mm
	from	80 pcs. 1,18 ea.	Countersink t: 2,48 mm
			Tolerance: +/- 0,1 mm
CS-S-27-04-N Disc magnet Ø 27 mm, height 4 mm with countersunk borehole N35, nickel-plated Weight: 16 g strength: approx. 8 kg		Price in EUR	Diameter D: 27 mm
		1 pc. 2,40 ea.	Height H: 4 mm
	from	3 pcs. 2,11 ea.	Borehole d1: 4,5 mm
	from	10 pcs. 1,86 ea.	Borehole d2: 9,46 mm
	from	20 pcs. 1,73 ea.	Countersink t: 2,48 mm
	from	40 pcs. 1,62 ea.	Tolerance: +/- 0,1 mm
CS-S-34-04-N Disc magnet Ø 34 mm, height 4 mm with countersunk borehole N35, nickel-plated Weight: 27 g strength: approx. 10 kg		Price in EUR	Diameter D: 34 mm
		1 pc. 3,17 ea.	Height H: 4 mm
	from	3 pcs. 2,76 ea.	Borehole d1: 4,5 mm
	from	10 pcs. 2,40 ea.	Borehole d2: 9,46 mm
	from	20 pcs. 2,22 ea.	Countersink t: 2,48 mm
	from	40 pcs. 2,07 ea.	Tolerance: +/- 0,1 mm
CS-S-42-04-N Disc magnet Ø 42 mm, height 4 mm with countersunk borehole N35, nickel-plated Weight: 35 g strength: approx. 12 kg		Price in EUR	Diameter D: 42 mm
		1 pc. 4,23 ea.	Height H: 4 mm
	from	3 pcs. 3,70 ea.	Borehole d1: 4,5 mm
	from	10 pcs. 3,23 ea.	Borehole d2: 9,46 mm
	from	20 pcs. 3,00 ea.	Countersink t: 2,48 mm
	from	40 pcs. 2,79 ea.	Tolerance: +/- 0,1 mm
CS-S-50-04-N Disc magnet Ø 50 mm, height 4 mm with countersunk borehole N35, nickel-plated Weight: 59 g strength: approx. 14 kg		Price in EUR	Diameter D: 50 mm
		1 pc. 5,70 ea.	Height H: 4 mm
	from	3 pcs. 5,01 ea.	Borehole d1: 4,5 mm
	from	10 pcs. 4,39 ea.	Borehole d2: 9,46 mm
	from	20 pcs. 4,08 ea.	Countersink t: 2,48 mm
	from	40 pcs. 3,82 ea.	Tolerance: +/- 0,1 mm
CS-Q-15-15-04-N Block magnet 15 x 15 x 4 mm with countersunk borehole N35, nickel-plated Weight: 5,8 g strength: approx. 4 kg		Price in EUR	Length S1: 15 mm
		5 pcs. 1,29 ea.	Length S2: 15 mm
	from	15 pcs. 1,11 ea.	Height H: 4 mm
	from	40 pcs. 0,97 ea.	Borehole d1: 4,5 mm
	from	80 pcs. 0,88 ea.	Countersink d2: 9,46 mm
			Countersink t: 2,48 mm

<p>CS-Q-20-20-04-N Block magnet 20 x 20 x 4 mm with countersunk borehole N35, nickel-plated Weight: 11 g strength: approx. 7,5 kg</p>	<p>Price in EUR 5 pcs. 1,73 ea. from 15 pcs. 1,51 ea. from 40 pcs. 1,34 ea. from 80 pcs. 1,23 ea.</p>	<p>Length S1: 20 mm Length S2: 20 mm Height H: 4 mm Borehole d1: 4,5 mm Countersink d2: 9,46 mm Countersink t: 2,48 mm</p>
<p>CS-Q-40-20-04-N Block magnet 40 x 20 x 4 mm with countersunk borehole N35, nickel-plated Weight: 22 g strength: approx. 12 kg</p>	<p>Price in EUR 1 pc. 3,73 ea. from 3 pcs. 3,26 ea. from 10 pcs. 2,85 ea. from 20 pcs. 2,65 ea. from 40 pcs. 2,47 ea.</p>	<p>Length S1: 40 mm Length S2: 20 mm Height H: 4 mm Borehole d1: 4,5 mm Countersink d2: 9,46 mm Countersink t: 2,48 mm</p>
<p>CS-Q-40-40-04-N Block magnet 40 x 40 x 4 mm with countersunk borehole N35, nickel-plated Weight: 47 g strength: approx. 16 kg</p>	<p>Price in EUR 1 pc. 5,58 ea. from 3 pcs. 4,85 ea. from 10 pcs. 4,20 ea. from 20 pcs. 3,88 ea. from 40 pcs. 3,60 ea.</p>	<p>Length S1: 40 mm Length S2: 40 mm Height H: 4 mm Borehole d1: 4,5 mm Countersink d2: 9,46 mm Countersink t: 2,48 mm</p>
<p>CS-Q-60-20-04-N Block magnet 60 x 20 x 4 mm with countersunk borehole N35, nickel-plated Weight: 34 g strength: approx. 13 kg</p>	<p>Price in EUR 1 pc. 5,10 ea. from 3 pcs. 4,43 ea. from 10 pcs. 3,83 ea. from 20 pcs. 3,53 ea. from 40 pcs. 3,28 ea.</p>	<p>Length S1: 60 mm Length S2: 20 mm Height H: 4 mm Borehole d1: 4,5 mm Countersink d2: 9,46 mm Countersink t: 2,48 mm</p>
<p>CS-Q-80-20-04-N Block magnet 80 x 20 x 4 mm with countersunk borehole N35, nickel-plated Weight: 47 g strength: approx. 18 kg</p>	<p>Price in EUR 1 pc. 6,96 ea. from 3 pcs. 6,21 ea. from 10 pcs. 5,54 ea. from 20 pcs. 5,22 ea. from 40 pcs. 4,93 ea.</p>	<p>Length S1: 80 mm Length S2: 20 mm Height H: 4 mm Borehole d1: 4,5 mm Countersink d2: 9,46 mm Countersink t: 2,48 mm</p>

Ferrite disc magnets

All ferrite disc magnets have their north and south poles on the even circular surfaces (axial magnetisation).

<p>FE-S-05-05 Disc magnet Ø 5 mm, height 5 mm Tolerance: +/- 0,1 mm, +/- 0,1 mm Weight: 0,48 g no coating Magnetisation: Y35 strength: approx. 100 g</p>	<p>Price in EUR 100 pcs. 0,12 ea. from 300 pcs. 0,10 ea. from 700 pcs. 0,09 ea. from 1600 pcs. 0,08 ea.</p>
<p>FE-S-10-03 Disc magnet Ø 10 mm, height 3 mm Tolerance: +/- 0,1 mm, +/- 0,1 mm Weight: 1,1 g no coating Magnetisation: Y35 strength: approx. 200 g</p>	<p>Price in EUR 20 pcs. 0,20 ea. from 60 pcs. 0,17 ea. from 140 pcs. 0,15 ea. from 360 pcs. 0,13 ea.</p>
<p>FE-S-10-05 Disc magnet Ø 10 mm, height 5 mm Tolerance: +/- 0,1 mm, +/- 0,1 mm Weight: 1,9 g no coating Magnetisation: Y35 strength: approx. 300 g</p>	<p>Price in EUR 20 pcs. 0,22 ea. from 60 pcs. 0,19 ea. from 140 pcs. 0,17 ea. from 360 pcs. 0,15 ea.</p>
<p>FE-S-10-10 Disc magnet Ø 10 mm, height 10 mm Tolerance: +/- 0,1 mm, +/- 0,1 mm Weight: 3,8 g no coating Magnetisation: Y35 strength: approx. 400 g</p>	<p>Price in EUR 10 pcs. 0,23 ea. from 40 pcs. 0,19 ea. from 80 pcs. 0,17 ea. from 160 pcs. 0,16 ea.</p>
<p>FE-S-100-15 Disc magnet Ø 100 mm, height 15 mm Tolerance: +/- 2,0 mm, +/- 0,1 mm Weight: 570 g no coating Magnetisation: Y35 strength: approx. 11 kg</p>	<p>Price in EUR 1 pc. 8,40 ea. from 3 pcs. 7,60 ea. from 10 pcs. 6,89 ea. from 20 pcs. 6,54 ea. from 40 pcs. 6,24 ea.</p>
<p>FE-S-12-05 Disc magnet Ø 12 mm, height 5 mm Tolerance: +/- 0,1 mm, +/- 0,1 mm Weight: 2,7 g no coating Magnetisation: Y35 strength: approx. 400 g</p>	<p>Price in EUR 10 pcs. 0,18 ea. from 40 pcs. 0,14 ea. from 80 pcs. 0,13 ea. from 160 pcs. 0,12 ea.</p>
<p>FE-S-15-05 Disc magnet Ø 15 mm, height 5 mm Tolerance: +/- 0,1 mm, +/- 0,1 mm Weight: 4,3 g no coating Magnetisation: Y35 strength: approx. 550 g</p>	<p>Price in EUR 10 pcs. 0,28 ea. from 40 pcs. 0,23 ea. from 80 pcs. 0,21 ea. from 160 pcs. 0,19 ea.</p>
<p>FE-S-15-10 Disc magnet Ø 15 mm, height 10 mm Tolerance: +/- 0,1 mm, +/- 0,1 mm Weight: 8,6 g no coating Magnetisation: Y35 strength: approx. 750 g</p>	<p>Price in EUR 10 pcs. 0,34 ea. from 20 pcs. 0,29 ea. from 40 pcs. 0,26 ea. from 80 pcs. 0,24 ea.</p>

FE-S-20-03		Price in EUR	
Disc magnet Ø 20 mm, height 3 mm		15 pcs.	0,18 ea.
Tolerance: +/- 0,1 mm, +/- 0,1 mm	from	45 pcs.	0,15 ea.
Weight: 4,6 g no coating	from	105 pcs.	0,14 ea.
Magnetisation: Y35 strength: approx. 400 g	from	240 pcs.	0,12 ea.
FE-S-20-05		Price in EUR	
Disc magnet Ø 20 mm, height 5 mm		10 pcs.	0,23 ea.
Tolerance: +/- 0,1 mm, +/- 0,1 mm	from	40 pcs.	0,19 ea.
Weight: 7,6 g no coating	from	80 pcs.	0,17 ea.
Magnetisation: Y35 strength: approx. 700 g	from	160 pcs.	0,16 ea.
FE-S-20-10		Price in EUR	
Disc magnet Ø 20 mm, height 10 mm		10 pcs.	0,38 ea.
Tolerance: +/- 0,1 mm, +/- 0,1 mm	from	40 pcs.	0,32 ea.
Weight: 15 g no coating	from	80 pcs.	0,29 ea.
Magnetisation: Y35 strength: approx. 1,4 kg	from	160 pcs.	0,27 ea.
FE-S-25-05		Price in EUR	
Disc magnet Ø 25 mm, height 5 mm		10 pcs.	0,24 ea.
Tolerance: +/- 0,1 mm, +/- 0,1 mm	from	40 pcs.	0,20 ea.
Weight: 12 g no coating	from	80 pcs.	0,18 ea.
Magnetisation: Y35 strength: approx. 800 g	from	160 pcs.	0,16 ea.
FE-S-25-10		Price in EUR	
Disc magnet Ø 25 mm, height 10 mm		10 pcs.	0,41 ea.
Tolerance: +/- 0,1 mm, +/- 0,1 mm	from	40 pcs.	0,35 ea.
Weight: 24 g no coating	from	80 pcs.	0,32 ea.
Magnetisation: Y35 strength: approx. 1,5 kg	from	160 pcs.	0,29 ea.
FE-S-25-15		Price in EUR	
Disc magnet Ø 25 mm, height 15 mm		5 pcs.	0,63 ea.
Tolerance: +/- 0,1 mm, +/- 0,1 mm	from	15 pcs.	0,55 ea.
Weight: 36 g no coating	from	40 pcs.	0,49 ea.
Magnetisation: Y35 strength: approx. 2,3 kg	from	80 pcs.	0,46 ea.
FE-S-30-05		Price in EUR	
Disc magnet Ø 30 mm, height 5 mm		10 pcs.	0,42 ea.
Tolerance: +/- 0,6 mm, +/- 0,1 mm	from	40 pcs.	0,35 ea.
Weight: 17 g no coating	from	80 pcs.	0,33 ea.
Magnetisation: Y35 strength: approx. 900 g	from	160 pcs.	0,30 ea.
FE-S-30-10		Price in EUR	
Disc magnet Ø 30 mm, height 10 mm		5 pcs.	0,54 ea.
Tolerance: +/- 0,6 mm, +/- 0,1 mm	from	15 pcs.	0,47 ea.
Weight: 34 g no coating	from	40 pcs.	0,42 ea.
Magnetisation: Y35 strength: approx. 2,3 kg	from	80 pcs.	0,39 ea.
FE-S-30-15		Price in EUR	
Disc magnet Ø 30 mm, height 15 mm		5 pcs.	0,73 ea.
Tolerance: +/- 0,6 mm, +/- 0,1 mm	from	15 pcs.	0,64 ea.
Weight: 51 g no coating	from	40 pcs.	0,57 ea.
Magnetisation: Y35 strength: approx. 3 kg	from	80 pcs.	0,54 ea.

FE-S-40-10		Price in EUR	
Disc magnet Ø 40 mm, height 10 mm		5 pcs.	1,28 ea.
Tolerance: +/- 0,8 mm, +/- 0,1 mm	from	15 pcs.	1,15 ea.
Weight: 61 g		from 40 pcs.	1,04 ea.
no coating		from 80 pcs.	0,98 ea.
Magnetisation: Y35	from		
strength: approx. 2,4 kg			
FE-S-40-20		Price in EUR	
Disc magnet Ø 40 mm, height 20 mm		1 pc.	1,87 ea.
Tolerance: +/- 0,8 mm, +/- 0,1 mm	from	3 pcs.	1,65 ea.
Weight: 120 g		from 10 pcs.	1,46 ea.
no coating		from 20 pcs.	1,37 ea.
Magnetisation: Y35	from	40 pcs.	1,29 ea.
strength: approx. 4,7 kg			
FE-S-60-15		Price in EUR	
Disc magnet Ø 60 mm, height 15 mm		1 pc.	2,51 ea.
Tolerance: +/- 1,2 mm, +/- 0,1 mm	from	3 pcs.	2,23 ea.
Weight: 210 g		from 10 pcs.	1,99 ea.
no coating		from 20 pcs.	1,87 ea.
Magnetisation: Y35	from	40 pcs.	1,76 ea.
strength: approx. 4,9 kg			
FE-S-70-15		Price in EUR	
Disc magnet Ø 70 mm, height 15 mm		1 pc.	3,55 ea.
Tolerance: +/- 1,4 mm, +/- 0,1 mm	from	3 pcs.	3,18 ea.
Weight: 280 g		from 10 pcs.	2,84 ea.
no coating		from 20 pcs.	2,68 ea.
Magnetisation: Y35	from	40 pcs.	2,54 ea.
strength: approx. 8,4 kg			

Ferrite block magnets

All ferrite block magnets have their north and south poles on the two largest surfaces.

<p>FE-Q-07-07-05 Block magnet 7 x 7 x 5 mm Tolerance: +/- 0,2 mm, +/- 0,2 mm, +/- 0,1mm Weight: 1,2 g no coating Magnetisation: Y35 strength: approx. 200 g</p>	<p>Price in EUR 40 pcs. 0,15 ea. from 120 pcs. 0,13 ea. from 280 pcs. 0,11 ea. from 640 pcs. 0,10 ea.</p>
<p>FE-Q-18-10-06 Block magnet 18 x 10 x 6 mm Tolerance: +/- 0,2 mm, +/- 0,2 mm, +/- 0,1 mm Weight: 5,2 g no coating Magnetisation: Y35 strength: approx. 630 g</p>	<p>Price in EUR 10 pcs. 0,38 ea. from 40 pcs. 0,30 ea. from 80 pcs. 0,27 ea. from 160 pcs. 0,24 ea.</p>
<p>FE-Q-20-20-03 Block magnet 20 x 20 x 3 mm Tolerance: +/- 0,2 mm, +/- 0,2 mm, +/- 0,1 mm Weight: 5,8 g no coating Magnetisation: Y35 strength: approx. 450 g</p>	<p>Price in EUR 10 pcs. 0,47 ea. from 40 pcs. 0,38 ea. from 80 pcs. 0,34 ea. from 160 pcs. 0,31 ea.</p>
<p>FE-Q-25-20-06 Block magnet 25 x 20 x 6 mm Tolerance: +/- 0,5 mm, +/- 0,4 mm, +/- 0,1 mm Weight: 15 g no coating Magnetisation: Y35 strength: approx. 1,2 kg</p>	<p>Price in EUR 5 pcs. 0,54 ea. from 15 pcs. 0,45 ea. from 40 pcs. 0,39 ea. from 80 pcs. 0,35 ea.</p>
<p>FE-Q-30-20-06 Block magnet 30 x 20 x 6 mm Tolerance: +/- 0,6 mm, +/- 0,4 mm, +/- 0,1 mm Weight: 17 g no coating Magnetisation: Y35 strength: approx. 1,4 kg</p>	<p>Price in EUR 10 pcs. 0,56 ea. from 40 pcs. 0,45 ea. from 80 pcs. 0,41 ea. from 160 pcs. 0,37 ea.</p>
<p>FE-Q-40-20-10 Block magnet 40 x 20 x 10 mm Tolerance: +/- 0,8 mm, +/- 0,4 mm, +/- 0,1 mm Weight: 39 g no coating Magnetisation: Y35 strength: approx. 2,5 kg</p>	<p>Price in EUR 5 pcs. 1,04 ea. from 15 pcs. 0,89 ea. from 40 pcs. 0,78 ea. from 80 pcs. 0,71 ea.</p>
<p>FE-Q-50-50-05 Block magnet 50 x 50 x 5 mm Tolerance: +/- 1,0 mm, +/- 1,0 mm, +/- 0,1 mm Weight: 61 g no coating Magnetisation: Y35 strength: approx. 2 kg</p>	<p>Price in EUR 5 pcs. 1,65 ea. from 15 pcs. 1,44 ea. from 40 pcs. 1,28 ea. from 80 pcs. 1,19 ea.</p>
<p>FE-Q-60-30-10 Block magnet 60 x 30 x 10 mm Tolerance: +/- 1,2 mm, +/- 0,6 mm, +/- 0,1 mm Weight: 87 g no coating Magnetisation: Y35 strength: approx. 4,1 kg</p>	<p>Price in EUR 1 pc. 3,09 ea. from 3 pcs. 2,70 ea. from 10 pcs. 2,36 ea. from 20 pcs. 2,19 ea. from 40 pcs. 2,04 ea.</p>

Ferrite ring magnets

All ferrite ring magnets have their south and north poles on the even circular surfaces (axial magnetisation).

<p>FE-R-100-60-20 Ring magnet Ø 100/60 mm, height 20 mm Tolerance: +/- 2,0 mm, +/- 1,2 mm, +/- 0,1 mm Weight: 490 g no coating Magnetisation: Y35 strength: approx. 16 kg</p>	<p>Price in EUR</p> <p>1 pc. 4,12 ea. from 3 pcs. 3,70 ea. from 10 pcs. 3,32 ea. from 20 pcs. 3,13 ea. from 40 pcs. 2,97 ea.</p>
<p>FE-R-22-06-05 Ring magnet Ø 22/6 mm, height 5 mm Tolerance: +/- 0,44 mm, +/- 0,2 mm, +/- 0,1 mm Weight: 8,5 g no coating Magnetisation: Y35 strength: approx. 820 g</p>	<p>Price in EUR</p> <p>15 pcs. 0,31 ea. from 45 pcs. 0,27 ea. from 105 pcs. 0,24 ea. from 240 pcs. 0,22 ea.</p>
<p>FE-R-30-16-08 Ring magnet Ø 30/16 mm, height 8 mm Tolerance: +/- 0,6 mm, +/- 0,32 mm, +/- 0,1 mm Weight: 20 g no coating Magnetisation: Y35 strength: approx. 1,6 kg</p>	<p>Price in EUR</p> <p>10 pcs. 0,30 ea. from 40 pcs. 0,25 ea. from 80 pcs. 0,23 ea. from 160 pcs. 0,21 ea.</p>
<p>FE-R-40-22-09 Ring magnet Ø 40/22 mm, height 9 mm Tolerance: +/- 0,8 mm, +/- 0,44 mm, +/- 0,1 mm Weight: 38 g no coating Magnetisation: Y35 strength: approx. 2,7 kg</p>	<p>Price in EUR</p> <p>12 pcs. 0,41 ea. from 36 pcs. 0,36 ea. from 84 pcs. 0,32 ea. from 204 pcs. 0,29 ea.</p>
<p>FE-R-60-20-10 Ring magnet Ø 60/20 mm, height 10 mm Tolerance: +/- 1,2 mm, +/- 0,4 mm, +/- 0,1 mm Weight: 120 g no coating Magnetisation: Y35 strength: approx. 4 kg</p>	<p>Price in EUR</p> <p>1 pc. 1,99 ea. from 3 pcs. 1,76 ea. from 10 pcs. 1,56 ea. from 20 pcs. 1,46 ea. from 40 pcs. 1,38 ea.</p>
<p>FE-R-80-40-15 Ring magnet Ø 80/40 mm, height 15 mm Tolerance: +/- 1,6 mm, +/- 0,8 mm, +/- 0,1 mm Weight: 270 g no coating Magnetisation: Y35 strength: approx. 9,5 kg</p>	<p>Price in EUR</p> <p>1 pc. 2,85 ea. from 3 pcs. 2,54 ea. from 10 pcs. 2,27 ea. from 20 pcs. 2,14 ea. from 40 pcs. 2,02 ea.</p>

Pot magnets with counterbore screw-on

Distinctive feature: These magnets can be fastened with a countersunk screw.

Principle: The magnets are embedded in a steel pot. The steel pot increases the adhesive force of the magnet on direct contact with a thick iron surface. If there is no direct contact with the counterpart, or if the steel plate is thin, painted or rough, you won't be able to put as much strain on it.

Shear force: The indicated adhesive force was measured perpendicular to the surface to which the magnet should stick. It takes a lot less strength to move the magnet sideways. Therefore, you won't be able to put as much strain on a pot magnet if you use it on a wall as opposed to using it on the ceiling.

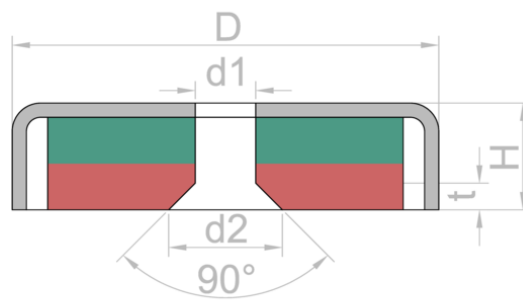

© supermagnete.com

Rust: These magnets are not rust-free and therefore intended for dry indoor use.

CSN-10 Countersunk pot magnet Ø 10 mm Weight: 2 g strength: approx. 1,3 kg	Price in EUR 5 pcs. 1,42 ea. from 15 pcs. 1,22 ea. from 40 pcs. 1,07 ea. from 80 pcs. 0,98 ea.	Diameter D: 10 mm Total height H: 4,5 mm Borehole d1: 3 mm Borehole d2: 4,8 mm Countersinking t: 0,9 mm Tolerance: +/- 0,1 mm
CSN-13 Countersunk pot magnet Ø 13 mm Weight: 3 g strength: approx. 3 kg	Price in EUR 5 pcs. 1,62 ea. from 15 pcs. 1,40 ea. from 40 pcs. 1,24 ea. from 80 pcs. 1,14 ea.	Diameter D: 13 mm Total height H: 4,5 mm Borehole d1: 3 mm Borehole d2: 5,5 mm Countersinking t: 1,25 mm Tolerance: +/- 0,1 mm
CSN-16 Countersunk pot magnet Ø 16 mm Weight: 5 g strength: approx. 4 kg	Price in EUR 5 pcs. 1,69 ea. from 15 pcs. 1,46 ea. from 40 pcs. 1,29 ea. from 80 pcs. 1,19 ea.	Diameter D: 16 mm Total height H: 4,5 mm Borehole d1: 3,5 mm Borehole d2: 7,22 mm Countersinking t: 1,86 mm Tolerance: +/- 0,1 mm
CSN-ES-16 Countersunk pot magnet Ø 16 mm Weight: 5,5 g strength: approx. 6,9 kg	Price in EUR 5 pcs. 1,72 ea. from 15 pcs. 1,49 ea. from 40 pcs. 1,32 ea. from 80 pcs. 1,21 ea.	Similar dimensions as CSN-16, but with a thicker steel pot. Hence higher adhesive force than CSN-16.
CSN-HT-16 Countersunk pot magnet Ø 16 mm Weight: 5 g strength: approx. 4 kg	Price in EUR 5 pcs. 1,90 ea. from 15 pcs. 1,66 ea. from 40 pcs. 1,47 ea. from 80 pcs. 1,36 ea.	This magnet in a steel pot has a countersunk borehole and can be fastened with a countersunk screw. Its design is identical to CSN-16, but this magnet is heat-resistant up to 150°C.
CSN-20 Countersunk pot magnet Ø 20 mm Weight: 11 g strength: approx. 8,9 kg	Price in EUR 1 pc. 2,89 ea. from 3 pcs. 2,51 ea. from 10 pcs. 2,17 ea. from 20 pcs. 2,00 ea. from 40 pcs. 1,85 ea.	Diameter D: 20 mm Total height H: 6 mm Borehole d1: 4,5 mm Borehole d2: 9,46 mm Countersinking t: 2,48 mm Tolerance: +/- 0,1 mm

<p>CSN-ES-20 Countersunk pot magnet Ø 20 mm Weight: 12 g strength: approx. 11 kg</p>	<p>Price in EUR</p> <p>1 pc. 3,14 ea. from 3 pcs. 2,73 ea. from 10 pcs. 2,36 ea. from 20 pcs. 2,18 ea. from 40 pcs. 2,03 ea.</p>	<p>Similar dimensions as CSN-20, but with a thicker steel pot. Hence higher adhesive force than CSN-20.</p>
<p>CSN-HT-20 Countersunk pot magnet Ø 20 mm Weight: 11 g strength: approx. 8,9 kg</p>	<p>Price in EUR</p> <p>1 pc. 3,29 ea. from 3 pcs. 2,86 ea. from 10 pcs. 2,48 ea. from 20 pcs. 2,30 ea. from 40 pcs. 2,14 ea.</p>	<p>This magnet in a steel pot has a countersunk borehole and can be fastened with a countersunk screw. Its design is identical to CSN-20, but this magnet is heat-resistant up to 150°C.</p>
<p>CSN-25 Countersunk pot magnet Ø 25 mm Weight: 20 g strength: approx. 19 kg</p>	<p>Price in EUR</p> <p>1 pc. 3,82 ea. from 3 pcs. 3,34 ea. from 10 pcs. 2,91 ea. from 20 pcs. 2,70 ea. from 40 pcs. 2,52 ea.</p>	<p>Diameter D: 25 mm Total height H: 7 mm Borehole d1: 5,5 mm Borehole d2: 11,7 mm Countersinking t: 3,1 mm Tolerance: +/- 0,1 mm</p>
<p>CSN-HT-25 Countersunk pot magnet Ø 25 mm Weight: 20 g strength: approx. 19 kg</p>	<p>Price in EUR</p> <p>1 pc. 4,56 ea. from 3 pcs. 4,00 ea. from 10 pcs. 3,50 ea. from 20 pcs. 3,26 ea. from 40 pcs. 3,05 ea.</p>	<p>This magnet in a steel pot has a countersunk borehole and can be fastened with a countersunk screw. Its design is identical to CSN-25, but this magnet is heat-resistant up to 150°C.</p>
<p>CSN-32 Countersunk pot magnet Ø 32 mm Weight: 35 g strength: approx. 30 kg</p>	<p>Price in EUR</p> <p>1 pc. 5,94 ea. from 3 pcs. 5,24 ea. from 10 pcs. 4,62 ea. from 20 pcs. 4,31 ea. from 40 pcs. 4,05 ea.</p>	<p>Diameter D: 32 mm Total height H: 7 mm Borehole d1: 5,5 mm Borehole d2: 11,7 mm Countersinking t: 3,1 mm Tolerance: +/- 0,1 mm</p>
<p>CSN-HT-32 Countersunk pot magnet Ø 32 mm Weight: 35 g strength: approx. 30 kg</p>	<p>Price in EUR</p> <p>1 pc. 6,59 ea. from 3 pcs. 5,83 ea. from 10 pcs. 5,15 ea. from 20 pcs. 4,82 ea. from 40 pcs. 4,53 ea.</p>	<p>This magnet in a steel pot has a countersunk borehole and can be fastened with a countersunk screw. Its design is identical to CSN-32, but this magnet is heat-resistant up to 150°C.</p>
<p>CSN-40 Countersunk pot magnet Ø 40 mm Weight: 65 g strength: approx. 52 kg</p>	<p>Price in EUR</p> <p>1 pc. 7,81 ea. from 3 pcs. 6,93 ea. from 10 pcs. 6,14 ea. from 20 pcs. 5,75 ea. from 40 pcs. 5,42 ea.</p>	<p>Diameter D: 40 mm Total height H: 8 mm Borehole d1: 5,5 mm Borehole d2: 11,7 mm Countersinking t: 3,1 mm Tolerance: +/- 0,1 mm</p>
<p>CSN-48 Countersunk pot magnet Ø 48 mm Weight: 120 g strength: approx. 87 kg</p>	<p>Price in EUR</p> <p>1 pc. 11,43 ea. from 3 pcs. 10,20 ea. from 10 pcs. 9,10 ea. from 20 pcs. 8,56 ea. from 40 pcs. 8,09 ea.</p>	<p>Diameter D: 48 mm Total height H: 11,5 mm Borehole d1: 8,5 mm Borehole d2: 18,12 mm Countersinking t: 4,81 mm Tolerance: +/- 0,1 mm</p>
<p>CSN-60 Countersunk pot magnet Ø 60 mm Weight: 250 g strength: approx. 130 kg</p>	<p>Price in EUR</p> <p>1 pc. 20,72 ea. from 3 pcs. 18,63 ea. from 10 pcs. 16,76 ea. from 20 pcs. 15,85 ea. from 40 pcs. 15,05 ea.</p>	<p>Diameter D: 60 mm Total height H: 15 mm Borehole d1: 8,5 mm Borehole d2: 18,12 mm Countersinking t: 4,81 mm Tolerance: +/- 0,1 mm</p>

Hook magnets neodymium: strong & practical

Distinctive feature: These magnets can be used to hang up objects. The hook can be unscrewed. You can choose between the colours silver, white, black and green.

Principle: The magnets are embedded in a steel pot. The steel pot increases the adhesive force of the magnet on direct contact with a thick iron surface. If there is no direct contact with the counterpart, or if the steel plate is thin, painted or rough, the magnet will hold significantly less weight.

Shear force: The indicated adhesive force was measured perpendicular to the surface to which the magnet was attached. It takes a lot less strength to move the magnet sideways. Therefore, you won't be able to attach as much weight to a pot magnet when used on a wall as opposed to using it on the ceiling.

Rust: These magnets are not rust-proof and are intended for indoor use in dry conditions.

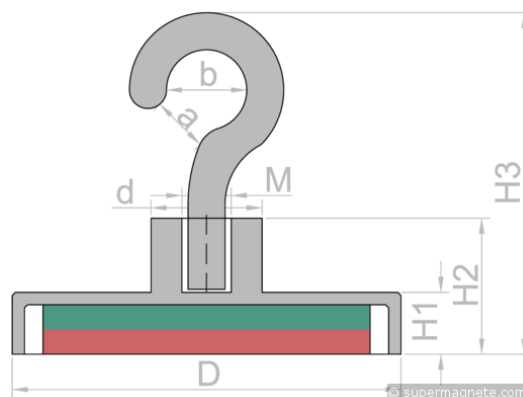

FTN-10 Hook magnet Ø 10 mm Thread M3 Weight: 5 g strength: approx. 3 kg	Price in EUR 5 pcs. 1,68 ea. from 15 pcs. 1,47 ea. from 40 pcs. 1,30 ea. from 80 pcs. 1,20 ea.	Pot diameter D: 10 mm Neck diameter d: 5 mm Pot height H1: 4,5 mm Total height without hook H2: 11,5 mm with hook H3: 26 mm
FTN-13 Hook magnet Ø 13 mm Thread M3 Weight: 6,5 g strength: approx. 5 kg	Price in EUR 5 pcs. 1,86 ea. from 15 pcs. 1,62 ea. from 40 pcs. 1,45 ea. from 80 pcs. 1,34 ea.	Pot diameter D: 13 mm Neck diameter d: 5 mm Pot height H1: 4,5 mm Total height without hook H2: 11,5 mm with hook H3: 26 mm
FTN-16 Hook magnet Ø 16 mm Thread M4 Weight: 11 g strength: approx. 8 kg	Price in EUR 5 pcs. 2,21 ea. from 15 pcs. 1,94 ea. from 40 pcs. 1,74 ea. from 80 pcs. 1,62 ea.	Pot diameter D: 16 mm Neck diameter d: 6 mm Pot height H1: 4,5 mm Total height without hook H2: 11,5 mm with hook H3: 27 mm
FTNW-16 Hook magnet white Ø 16,3 mm powder-coated thread M4 Weight: 11 g strength: approx. 6 kg	Price in EUR 1 pc. 2,54 ea. from 3 pcs. 2,24 ea. from 10 pcs. 1,97 ea. from 20 pcs. 1,84 ea. from 40 pcs. 1,73 ea.	Pot diameter D: 16,3 mm Neck diameter d: 6,3 mm Pot height H1: 4,8 mm Total height without hook H2: 11,8 mm Total height with hook H3: 27,3 mm Thread M: 4
FTNB-16 Hook magnet black Ø 16,3 mm powder-coated thread M4 Weight: 11 g strength: approx. 6 kg	Price in EUR 1 pc. 2,54 ea. from 3 pcs. 2,23 ea. from 10 pcs. 1,94 ea. from 20 pcs. 1,81 ea. from 40 pcs. 1,69 ea.	Pot diameter D: 16,3 mm Neck diameter d: 6,3 mm Pot height H1: 4,8 mm Total height without hook H2: 11,8 mm Total height with hook H3: 27,3 mm Thread M: 4
FTNG-16 Hook magnet green Ø 16,3 mm powder-coated thread M4 Weight: 11 g strength: approx. 6 kg	Price in EUR 1 pc. 2,54 ea. from 3 pcs. 2,23 ea. from 10 pcs. 1,95 ea. from 20 pcs. 1,81 ea. from 40 pcs. 1,69 ea.	Pot diameter D: 16,3 mm Neck diameter d: 6,3 mm Pot height H1: 4,8 mm Total height without hook H2: 11,8 mm Total height with hook H3: 27,3 mm Thread M: 4

FTN-20 Hook magnet Ø 20 mm Thread M4 Weight: 20 g strength: approx. 13 kg	Price in EUR 1 pc. 3,42 ea. from 3 pcs. 2,98 ea. from 10 pcs. 2,59 ea. from 20 pcs. 2,40 ea. from 40 pcs. 2,23 ea.	Pot diameter D: 20 mm Neck diameter d: 8 mm Pot height H1: 6 mm Total height without hook H2: 13 mm with hook H3: 29 mm
FTNB-20 Hook magnet black Ø 20,3 mm powder-coated thread M4 Weight: 20 g strength: approx. 13 kg	Price in EUR 1 pc. 3,44 ea. from 3 pcs. 3,01 ea. from 10 pcs. 2,63 ea. from 20 pcs. 2,44 ea. from 40 pcs. 2,27 ea.	Pot diameter D: 20,3 mm Neck diameter d: 8,3 mm Pot height H1: 6,3 mm Total height without hook H2: 13,3 mm Total height with hook H3: 29,3 mm Thread M: 4
FTNG-20 Hook magnet green Ø 20,3 mm powder-coated thread M4 Weight: 20 g strength: approx. 13 kg	Price in EUR 1 pc. 3,44 ea. from 3 pcs. 3,01 ea. from 10 pcs. 2,62 ea. from 20 pcs. 2,43 ea. from 40 pcs. 2,27 ea.	Pot diameter D: 20,3 mm Neck diameter d: 8,3 mm Pot height H1: 6,3 mm Total height without hook H2: 13,3 mm Total height with hook H3: 29,3 mm Thread M: 4
FTN-25 Hook magnet Ø 25 mm Thread M4 Weight: 30 g strength: approx. 18 kg	Price in EUR 1 pc. 4,03 ea. from 3 pcs. 3,52 ea. from 10 pcs. 3,08 ea. from 20 pcs. 2,86 ea. from 40 pcs. 2,67 ea.	Pot diameter D: 25 mm Neck diameter d: 8 mm Pot height H1: 7 mm Total height without hook H2: 14 mm with hook H3: 30 mm
FTNW-25 Hook magnet white Ø 25,3 mm powder-coated thread M4 Weight: 29 g strength: approx. 16 kg	Price in EUR 1 pc. 4,06 ea. from 3 pcs. 3,59 ea. from 10 pcs. 3,18 ea. from 20 pcs. 2,97 ea. from 40 pcs. 2,79 ea.	Pot diameter D: 25,3 mm Neck diameter d: 8,3 mm Pot height H1: 7,3 mm Total height without hook H2: 14,3 mm Total height with hook H3: 30,3 mm Thread M: 4
FTNB-25 Hook magnet black Ø 25,3 mm powder-coated thread M4 Weight: 29 g strength: approx. 16 kg	Price in EUR 1 pc. 4,06 ea. from 3 pcs. 3,57 ea. from 10 pcs. 3,13 ea. from 20 pcs. 2,91 ea. from 40 pcs. 2,73 ea.	Pot diameter D: 25,3 mm Neck diameter d: 8,3 mm Pot height H1: 7,3 mm Total height without hook H2: 14,3 mm Total height with hook H3: 30,3 mm Thread M: 4
FTNG-25 Hook magnet green Ø 25,3 mm powder-coated thread M4 Weight: 29 g strength: approx. 16 kg	Price in EUR 1 pc. 4,06 ea. from 3 pcs. 3,58 ea. from 10 pcs. 3,14 ea. from 20 pcs. 2,93 ea. from 40 pcs. 2,75 ea.	Pot diameter D: 25,3 mm Neck diameter d: 8,3 mm Pot height H1: 7,3 mm Total height without hook H2: 14,3 mm Total height with hook H3: 30,3 mm Thread M: 4
FTNT-25 Pot magnet with rotating hook Ø 25 mm strength approx. 20 kg Weight: 37 g strength: approx. 20 kg	Price in EUR 1 pc. 4,50 ea. from 3 pcs. 3,96 ea. from 10 pcs. 3,47 ea. from 20 pcs. 3,24 ea. from 40 pcs. 3,03 ea.	This magnet hook is guaranteed to always point in the desired direction, as the hook is designed to turn freely around the magnet base. Height of the magnet pot: 15 mm. Maximum extension with positioned hook: approx. 63 mm.
FTN-32 Hook magnet Ø 32 mm Thread M5 Weight: 52 g strength: approx. 30 kg	Price in EUR 1 pc. 5,14 ea. from 3 pcs. 4,52 ea. from 10 pcs. 3,97 ea. from 20 pcs. 3,70 ea. from 40 pcs. 3,47 ea.	Pot diameter D: 32 mm Neck diameter d: 10 mm Pot height H1: 7 mm Total height without hook H2: 15,5 mm with hook H3: 45 mm

<p>FTNW-32 Hook magnet white Ø 32,3 mm powder-coated thread M5 Weight: 53 g strength: approx. 28 kg</p>	<p>Price in EUR</p> <p>1 pc. 5,17 ea. from 3 pcs. 4,62 ea. from 10 pcs. 4,12 ea. from 20 pcs. 3,87 ea. from 40 pcs. 3,66 ea.</p>	<p>Pot diameter D: 32,3 mm Neck diameter d: 10,3 mm Pot height H1: 7,3 mm Total height without hook H2: 15,8 mm Total height with hook H3: 45,3 mm Thread M: 5</p>
<p>FTNB-32 Hook magnet black Ø 32,3 mm powder-coated thread M5 Weight: 53 g strength: approx. 28 kg</p>	<p>Price in EUR</p> <p>1 pc. 5,17 ea. from 3 pcs. 4,57 ea. from 10 pcs. 4,02 ea. from 20 pcs. 3,76 ea. from 40 pcs. 3,53 ea.</p>	<p>Pot diameter D: 32,3 mm Neck diameter d: 10,3 mm Pot height H1: 7,3 mm Total height without hook H2: 15,8 mm Total height with hook H3: 45,3 mm Thread M: 5</p>
<p>FTNG-32 Hook magnet green Ø 32,3 mm powder-coated thread M5 Weight: 53 g strength: approx. 28 kg</p>	<p>Price in EUR</p> <p>1 pc. 5,17 ea. from 3 pcs. 4,58 ea. from 10 pcs. 4,05 ea. from 20 pcs. 3,79 ea. from 40 pcs. 3,56 ea.</p>	<p>Pot diameter D: 32,3 mm Neck diameter d: 10,3 mm Pot height H1: 7,3 mm Total height without hook H2: 15,8 mm Total height with hook H3: 45,3 mm Thread M: 5</p>
<p>KTN-25 Pot magnet with carabiner Ø 25 mm length of carabiner 60 mm Weight: 38 g strength: approx. 25 kg</p>	<p>Price in EUR</p> <p>1 pc. 4,71 ea. from 3 pcs. 4,19 ea. from 10 pcs. 3,73 ea. from 20 pcs. 3,50 ea. from 40 pcs. 3,30 ea.</p>	<p>This pot magnet with carabiner guarantees a secure hold of the mounted objects, even when they are pulled sideways. Therefore, it can be used wherever you would use eyelet or hook magnets otherwise, e.g. at home or in the workshop.</p>
<p>KTN-25B Pot magnet with blue carabiner Ø 25 mm length of carabiner 60 mm Weight: 38 g strength: approx. 25 kg</p>	<p>Price in EUR</p> <p>1 pc. 4,71 ea. from 3 pcs. 4,19 ea. from 10 pcs. 3,73 ea. from 20 pcs. 3,50 ea. from 40 pcs. 3,30 ea.</p>	<p>Pot diameter D: 25 mm Pot height H1: 8 mm Total height without carabiner H2: 18,5 mm Length of carabiner h1: 60 mm Max. weight on carabiner: 15 kg Magnetisation: N42</p>
<p>KTN-25P Pot magnet with pink carabiner Ø 25 mm length of carabiner 60 mm Weight: 38 g strength: approx. 25 kg</p>	<p>Price in EUR</p> <p>1 pc. 4,71 ea. from 3 pcs. 4,19 ea. from 10 pcs. 3,73 ea. from 20 pcs. 3,50 ea. from 40 pcs. 3,30 ea.</p>	<p>Pot diameter D: 25 mm Pot height H1: 8 mm Total height without carabiner H2: 18,5 mm Length of carabiner h1: 60 mm Max. weight on carabiner: 15 kg Magnetisation: N42</p>
<p>KTN-32 Pot magnet with carabiner Ø 32 mm length of carabiner 60 mm Weight: 55 g strength: approx. 39 kg</p>	<p>Price in EUR</p> <p>1 pc. 5,91 ea. from 3 pcs. 5,32 ea. from 10 pcs. 4,79 ea. from 20 pcs. 4,53 ea. from 40 pcs. 4,30 ea.</p>	<p>This pot magnet with carabiner guarantees a secure hold of the mounted objects, even when they are pulled sideways. Therefore, it can be used wherever you would use eyelet or hook magnets otherwise, e.g. at home or in the workshop.</p>
<p>KTN-32B Pot magnet with blue carabiner Ø 32 mm length of carabiner 60 mm Weight: 55 g strength: approx. 39 kg</p>	<p>Price in EUR</p> <p>1 pc. 5,93 ea. from 3 pcs. 5,34 ea. from 10 pcs. 4,80 ea. from 20 pcs. 4,54 ea. from 40 pcs. 4,32 ea.</p>	<p>Pot diameter D: 32 mm Pot height H1: 8 mm Total height without carabiner H2: 18,5 mm Length of carabiner h1: 60 mm Max. weight on carabiner: 15 kg Magnetisation: N42</p>
<p>KTN-32P Pot magnet with pink carabiner Ø 32 mm length of carabiner 60 mm Weight: 55 g strength: approx. 39 kg</p>	<p>Price in EUR</p> <p>1 pc. 5,93 ea. from 3 pcs. 5,34 ea. from 10 pcs. 4,80 ea. from 20 pcs. 4,54 ea. from 40 pcs. 4,32 ea.</p>	<p>Pot diameter D: 32 mm Pot height H1: 8 mm Total height without carabiner H2: 18,5 mm Length of carabiner h1: 60 mm Max. weight on carabiner: 15 kg Magnetisation: N42</p>

<p>FTNT-40-B Pot magnet with rotating hook Ø 40,2 mm black, with rubberised surface Weight: 87 g strength: approx. 22 kg</p>	<p>Price in EUR 1 pc. 9,93 ea. from 3 pcs. 8,85 ea. from 10 pcs. 7,89 ea. from 20 pcs. 7,42 ea. from 40 pcs. 7,00 ea.</p>	<p>Hook opening width a: 18 mm Pot height H: 18 mm Pot diameter D: 40,2 mm Thickness rubber: 0,5 mm Coating: Nickel (ni), powder-coated black</p>
<p>FTN-40 Hook magnet Ø 40 mm Thread M6 Weight: 120 g strength: approx. 55 kg</p>	<p>Price in EUR 1 pc. 9,89 ea. from 3 pcs. 8,83 ea. from 10 pcs. 7,89 ea. from 20 pcs. 7,43 ea. from 40 pcs. 7,02 ea.</p>	<p>Pot diameter D: 40 mm Neck diameter d: 15 mm Pot height H1: 9 mm Total height without hook H2: 18 mm with hook H3: 59 mm</p>
<p>FTNW-40 Hook magnet white Ø 40,3 mm powder-coated thread M6 Weight: 110 g strength: approx. 50 kg</p>	<p>Price in EUR 1 pc. 9,95 ea. from 3 pcs. 8,92 ea. from 10 pcs. 7,99 ea. from 20 pcs. 7,54 ea. from 40 pcs. 7,15 ea.</p>	<p>Pot diameter D: 40,3 mm Neck diameter d: 15,3 mm Pot height H1: 9,3 mm Total height without hook H2: 18,3 mm Total height with hook H3: 59,3 mm Thread M: 6</p>
<p>FTN-50 Hook magnet Ø 50 mm Thread M8 Weight: 170 g strength: approx. 75 kg</p>	<p>Price in EUR 1 pc. 14,95 ea. from 3 pcs. 13,43 ea. from 10 pcs. 12,08 ea. from 20 pcs. 11,42 ea. from 40 pcs. 10,83 ea.</p>	<p>Pot diameter D: 50 mm Neck diameter d: 15 mm Pot height H1: 9 mm Total height without hook H2: 18 mm with hook H3: 62 mm</p>
<p>FTN-63 Hook magnet Ø 63 mm Thread M8 Weight: 270 g strength: approx. 110 kg</p>	<p>Price in EUR 1 pc. 19,89 ea. from 3 pcs. 17,97 ea. from 10 pcs. 16,26 ea. from 20 pcs. 15,43 ea. from 40 pcs. 14,69 ea.</p>	<p>Pot diameter D: 63 mm Neck diameter d: 18 mm Pot height H1: 10 mm Total height without hook H2: 22 mm with hook H3: 66 mm</p>
<p>FTN-75 Hook magnet Ø 75 mm Thread M10 Weight: 410 g strength: approx. 130 kg</p>	<p>Price in EUR 1 pc. 29,99 ea. from 3 pcs. 27,54 ea. from 10 pcs. 25,35 ea. from 20 pcs. 24,28 ea. from 40 pcs. 23,34 ea.</p>	<p>Pot diameter D: 75 mm Neck diameter d: 20 mm Pot height H1: 11 mm Total height without hook H2: 25 mm with hook H3: 70 mm</p>

Pot magnets with threaded stud

Distinctive feature: These magnets have an external thread.

Principle: The magnets are embedded in a steel pot. The steel pot increases the adhesive force of the magnet on direct contact with a thick iron surface. If there is no direct contact with the counterpart, or if the steel plate is thin, painted or rough, you won't be able to put as much strain on it.

Shear force: The indicated adhesive force was measured perpendicular to the surface to which the magnet should stick. It takes a lot less strength to move the magnet sideways. Therefore, you won't be able to put as much strain on a pot magnet if you use it on a wall as opposed to using it on the ceiling.

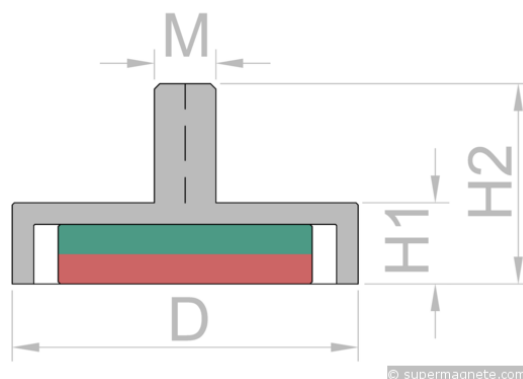

Rust: These magnets are not rust-free and therefore intended for dry indoor use.

<p>GTNG-22 rubber-coated pot magnet with threaded stud Ø 22 mm thread M4 Weight: 10 g strength: approx. 5,9 kg</p>	<p>Price in EUR</p> <p>1 pc. 3,41 ea. from 3 pcs. 2,97 ea. from 10 pcs. 2,58 ea. from 20 pcs. 2,40 ea. from 40 pcs. 2,23 ea.</p>	<p>The rubber coating protects delicate surfaces from scratches, increases the weight capacity in shear direction, and makes them slip-resistant.</p>
<p>GTNG-31 rubber-coated pot magnet with threaded stud Ø 31 mm thread M5 Weight: 21 g strength: approx. 9 kg</p>	<p>Price in EUR</p> <p>1 pc. 4,45 ea. from 3 pcs. 3,91 ea. from 10 pcs. 3,42 ea. from 20 pcs. 3,19 ea. from 40 pcs. 2,98 ea.</p>	<p>The rubber coating protects delicate surfaces from scratches, increases the weight capacity in shear direction, and makes them slip-resistant.</p>
<p>GTNG-43 rubber coated pot magnet with threaded stud Ø 43 mm thread M4 Weight: 30 g strength: approx. 9 kg</p>	<p>Price in EUR</p> <p>1 pc. 5,60 ea. from 3 pcs. 4,91 ea. from 10 pcs. 4,29 ea. from 20 pcs. 3,99 ea. from 40 pcs. 3,73 ea.</p>	<p>The rubber coating protects delicate surfaces from scratches, increases the weight capacity in shear direction, and makes them slip-resistant.</p>
<p>GTNG-66 rubber coated pot magnet with threaded stud Ø 66 mm thread M8 Weight: 110 g strength: approx. 22 kg</p>	<p>Price in EUR</p> <p>1 pc. 9,80 ea. from 3 pcs. 8,61 ea. from 10 pcs. 7,53 ea. from 20 pcs. 7,01 ea. from 40 pcs. 6,55 ea.</p>	<p>The rubber coating protects delicate surfaces from scratches, increases the weight capacity in shear direction, and makes them slip-resistant.</p>
<p>GTNG-88 rubber coated pot magnet with threaded stud Ø 88 mm thread M8 Weight: 190 g strength: approx. 50 kg</p>	<p>Price in EUR</p> <p>1 pc. 14,45 ea. from 3 pcs. 12,81 ea. from 10 pcs. 11,34 ea. from 20 pcs. 10,63 ea. from 40 pcs. 10,00 ea.</p>	<p>The rubber coating protects delicate surfaces from scratches, increases the weight capacity in shear direction, and makes them slip-resistant.</p>
<p>GTN-10 Pot magnet with threaded stud Ø 10 mm Thread M3 Weight: 3,5 g strength: approx. 2,5 kg</p>	<p>Price in EUR</p> <p>5 pcs. 1,69 ea. from 15 pcs. 1,47 ea. from 40 pcs. 1,30 ea. from 80 pcs. 1,20 ea.</p>	<p>Pot diameter D: 10 mm Pot height H1: 5 mm Total height H2: 12 mm Tolerance: +/- 0,1 mm Coating: Nickel-plated (Ni-Cu-Ni) Max. working temperature: 80°C</p>

GTN-13 Pot magnet with threaded stud Ø 13 mm Thread M3 Weight: 4 g strength: approx. 3,5 kg	Price in EUR 5 pcs. 2,05 ea. from 15 pcs. 1,80 ea. from 40 pcs. 1,60 ea. from 80 pcs. 1,49 ea.	Pot diameter D: 13 mm Pot height H1: 5 mm Total height H2: 12 mm Tolerance: +/- 0,1 mm Coating: Nickel-plated (Ni-Cu-Ni) Max. working temperature: 80°C
GTN-16 Pot magnet with threaded stud Ø 16 mm Thread M4 Weight: 7,3 g strength: approx. 8 kg	Price in EUR 5 pcs. 2,09 ea. from 15 pcs. 1,83 ea. from 40 pcs. 1,64 ea. from 80 pcs. 1,52 ea.	Pot diameter D: 16 mm Pot height H1: 5 mm Total height H2: 13,5 mm Tolerance: +/- 0,1 mm Coating: Nickel-plated (Ni-Cu-Ni) Max. working temperature: 80°C
GTN-20 Pot magnet with threaded stud Ø 20 mm Thread M4 Weight: 15 g strength: approx. 12 kg	Price in EUR 1 pc. 3,63 ea. from 3 pcs. 3,17 ea. from 10 pcs. 2,77 ea. from 20 pcs. 2,57 ea. from 40 pcs. 2,39 ea.	Pot diameter D: 20 mm Pot height H1: 7 mm Total height H2: 15,5 mm Tolerance: +/- 0,1 mm Coating: Nickel-plated (Ni-Cu-Ni) Max. working temperature: 80°C
GTN-25 Pot magnet with threaded stud Ø 25 mm Thread M5 Weight: 27 g strength: approx. 25 kg	Price in EUR 1 pc. 4,05 ea. from 3 pcs. 3,55 ea. from 10 pcs. 3,10 ea. from 20 pcs. 2,88 ea. from 40 pcs. 2,69 ea.	Pot diameter D: 25 mm Pot height H1: 8 mm Total height H2: 16,5 mm Tolerance: +/- 0,1 mm Coating: Nickel-plated (Ni-Cu-Ni) Max. working temperature: 80°C
GTN-32 Pot magnet with threaded stud Ø 32 mm Thread M6 Weight: 44 g strength: approx. 39 kg	Price in EUR 1 pc. 5,39 ea. from 3 pcs. 4,75 ea. from 10 pcs. 4,18 ea. from 20 pcs. 3,90 ea. from 40 pcs. 3,66 ea.	Pot diameter D: 32 mm Pot height H1: 8 mm Total height H2: 18,5 mm Tolerance: +/- 0,1 mm Coating: Nickel-plated (Ni-Cu-Ni) Max. working temperature: 80°C
GTN-40 Pot magnet with threaded stud Ø 40 mm Thread M8 Weight: 80 g strength: approx. 45 kg	Price in EUR 1 pc. 7,83 ea. from 3 pcs. 6,95 ea. from 10 pcs. 6,16 ea. from 20 pcs. 5,78 ea. from 40 pcs. 5,44 ea.	Pot diameter D: 40 mm Pot height H1: 9 mm Total height H2: 20 mm Tolerance: +/- 0,1 mm Coating: Nickel-plated (Ni-Cu-Ni) Max. working temperature: 80°C
GTN-48 Pot magnet with threaded stud Ø 48 mm Thread M8 Weight: 140 g strength: approx. 85 kg	Price in EUR 1 pc. 13,09 ea. from 3 pcs. 11,70 ea. from 10 pcs. 10,46 ea. from 20 pcs. 9,86 ea. from 40 pcs. 9,33 ea.	Pot diameter D: 48 mm Pot height H1: 11,5 mm Total height H2: 24 mm Tolerance: +/- 0,1 mm Coating: Nickel-plated (Ni-Cu-Ni) Max. working temperature: 80°C
GTN-60 Pot magnet with threaded stud Ø 60 mm Thread M8 Weight: 260 g strength: approx. 130 kg	Price in EUR 1 pc. 24,86 ea. from 3 pcs. 22,40 ea. from 10 pcs. 20,20 ea. from 20 pcs. 19,14 ea. from 40 pcs. 18,19 ea.	Pot diameter D: 60 mm Pot height H1: 15 mm Total height H2: 30 mm Tolerance: +/- 0,1 mm Coating: Nickel-plated (Ni-Cu-Ni) Max. working temperature: 80°C

Channel magnets

Channel magnets are rectangular or square pot magnets that can be fastened with a countersunk head screw. They consist of a U-shaped steel profile into which a neodymium block magnet is embedded. This design strengthens the holding power of the magnet enormously at direct contact with a counterpart. Additionally, the steel coating protects the fragile magnet from damages caused by repeated blows.

CSR-15-15-04-N Channel magnet 15 x 15 x 4 mm with counterbore in U-shaped steel profile Weight: 5,5 g strength: approx. 5,5 kg	Price in EUR 5 pcs. 1,63 ea. from 15 pcs. 1,41 ea. from 40 pcs. 1,25 ea. from 80 pcs. 1,15 ea.	Length S1: 15 mm Length S2: 15 mm Height H: 4 mm Borehole d1: 4,5 mm Countersink d2: 9,46 mm Countersink t: 2,48 mm
CSR-20-20-04-N Channel magnet 20 x 20 x 4 mm with counterbore in U-shaped steel profile Weight: 11 g strength: approx. 10 kg	Price in EUR 5 pcs. 1,95 ea. from 15 pcs. 1,70 ea. from 40 pcs. 1,51 ea. from 80 pcs. 1,40 ea.	Length S1: 20 mm Length S2: 20 mm Height H: 4 mm Borehole d1: 4,5 mm Countersink d2: 9,46 mm Countersink t: 2,48 mm
CSR-40-20-04-N Channel magnet 40 x 20 x 4 mm with counterbore in U-shaped steel profile Weight: 21 g strength: approx. 17 kg	Price in EUR 1 pc. 4,37 ea. from 3 pcs. 3,79 ea. from 10 pcs. 3,26 ea. from 20 pcs. 3,00 ea. from 40 pcs. 2,78 ea.	Length S1: 40 mm Length S2: 20 mm Height H: 4 mm Borehole d1: 4,5 mm Countersink d2: 9,46 mm Countersink t: 2,48 mm
CSR-40-40-04-N Channel magnet 40 x 40 x 4 mm with counterbore in U-shaped steel profile Weight: 44 g strength: approx. 25 kg	Price in EUR 1 pc. 6,61 ea. from 3 pcs. 5,84 ea. from 10 pcs. 5,16 ea. from 20 pcs. 4,83 ea. from 40 pcs. 4,54 ea.	Length S1: 40 mm Length S2: 40 mm Height H: 4 mm Borehole d1: 4,5 mm Countersink d2: 9,46 mm Countersink t: 2,48 mm
CSR-60-20-04-N Channel magnet 60 x 20 x 4 mm with counterbore in U-shaped steel profile Weight: 33 g strength: approx. 29 kg	Price in EUR 1 pc. 5,67 ea. from 3 pcs. 4,94 ea. from 10 pcs. 4,29 ea. from 20 pcs. 3,97 ea. from 40 pcs. 3,69 ea.	Length S1: 60 mm Length S2: 20 mm Height H: 4 mm Borehole d1: 4,5 mm Countersink d2: 9,46 mm Countersink t: 2,48 mm
CSR-80-20-04-N Channel magnet 80 x 20 x 4 mm with counterbore in U-shaped steel profile Weight: 44 g strength: approx. 37 kg	Price in EUR 1 pc. 7,43 ea. from 3 pcs. 6,58 ea. from 10 pcs. 5,83 ea. from 20 pcs. 5,46 ea. from 40 pcs. 5,13 ea.	Length S1: 80 mm Length S2: 20 mm Height H: 4 mm Borehole d1: 4,5 mm Countersink d2: 9,46 mm Countersink t: 2,48 mm

Eyelet magnets neodymium

Distinctive feature: These magnets are suitable for securely hanging up objects. The eyelet can be removed. You can choose between silver-coloured and white eyelet magnets. The latter are barely noticeable on white walls and ceilings. The silver eyelet magnets are slightly cheaper and stronger.

Principle: The magnets are embedded in a steel pot. The steel pot increases the adhesive force of the magnet on direct contact with a thick iron surface. If there is no direct contact with the counterpart, or if the steel plate is thin, painted or rough, you won't be able to put as much strain on it.

Shear force: The indicated adhesive force was measured perpendicular to the surface to which the magnet should stick. It takes a lot less strength to move the magnet sideways. Therefore, you won't be able to put as much strain on a pot magnet if you use it on a wall as opposed to using it on the ceiling.

Rust: These magnets are not rust-proof and therefore intended for dry indoor use.

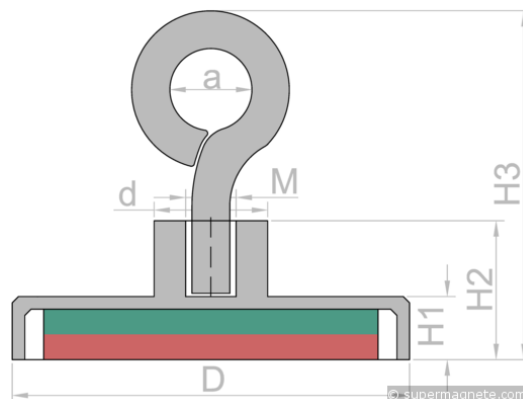

OTN-16 Pot magnet with eyelet Ø 16 mm thread M4 Weight: 10 g strength: approx. 8 kg	Price in EUR 5 pcs. 2,19 ea. from 15 pcs. 1,91 ea. from 40 pcs. 1,70 ea. from 80 pcs. 1,58 ea.	Pot diameter D: 16 mm Neck diameter d: 6 mm Pot height H1: 4,5 mm Total height without eyelet H2: 11,5 mm Total height with eyelet H3: 27 mm Thread M: 4
OTN-25 Pot magnet with eyelet Ø 25 mm thread M4 Weight: 29 g strength: approx. 18 kg	Price in EUR 1 pc. 4,03 ea. from 3 pcs. 3,51 ea. from 10 pcs. 3,05 ea. from 20 pcs. 2,82 ea. from 40 pcs. 2,62 ea.	Pot diameter D: 25 mm Neck diameter d: 8 mm Pot height H1: 7 mm Total height without eyelet H2: 14 mm Total height with eyelet H3: 30 mm Thread M: 4
OTN-32 Pot magnet with eyelet Ø 32 mm thread M5 Weight: 53 g strength: approx. 30 kg	Price in EUR 1 pc. 5,14 ea. from 3 pcs. 4,52 ea. from 10 pcs. 3,95 ea. from 20 pcs. 3,68 ea. from 40 pcs. 3,44 ea.	Pot diameter D: 32 mm Neck diameter d: 10 mm Pot height H1: 7 mm Total height without eyelet H2: 15,5 mm Total height with eyelet H3: 45 mm Thread M: 5
OTN-40 Pot magnet with eyelet Ø 40 mm thread M6 Weight: 110 g strength: approx. 55 kg	Price in EUR 1 pc. 9,90 ea. from 3 pcs. 8,76 ea. from 10 pcs. 7,74 ea. from 20 pcs. 7,24 ea. from 40 pcs. 6,80 ea.	Pot diameter D: 40 mm Neck diameter d: 15 mm Pot height H1: 9 mm Total height without eyelet H2: 18 mm Total height with eyelet H3: 59 mm Thread M: 6
OTNW-16 Pot magnet with eyelet white Ø 16,3 mm powder-coated thread M4 Weight: 11 g strength: approx. 6 kg	Price in EUR 1 pc. 2,22 ea. from 3 pcs. 1,95 ea. from 10 pcs. 1,71 ea. from 20 pcs. 1,59 ea. from 40 pcs. 1,49 ea.	Pot diameter D: 16,3 mm Neck diameter d: 6,3 mm Pot height H1: 4,8 mm Total height without eyelet H2: 11,8 mm Total height with eyelet H3: 27,3 mm Thread M: 4
OTNW-25 Pot magnet with eyelet white Ø 25,3 mm powder-coated thread M4 Weight: 30 g strength: approx. 16 kg	Price in EUR 1 pc. 4,06 ea. from 3 pcs. 3,56 ea. from 10 pcs. 3,12 ea. from 20 pcs. 2,91 ea. from 40 pcs. 2,72 ea.	Pot diameter D: 25,3 mm Neck diameter d: 8,3 mm Pot height H1: 7,3 mm Total height without eyelet H2: 14,3 mm Total height with eyelet H3: 30,3 mm Thread M: 4

OTNW-32		Price in EUR	Pot diameter D: 32,3 mm
Pot magnet with eyelet		1 pc. 5,17 ea.	Neck diameter d: 10,3 mm
white Ø 32,3 mm	from	3 pcs. 4,55 ea.	Pot height H1: 7,3 mm
powder-coated	from	10 pcs. 4,00 ea.	Total height without eyelet H2: 15,8 mm
thread M5	from	20 pcs. 3,73 ea.	Total height with eyelet H3: 45,3 mm
Weight: 56 g	from	40 pcs. 3,49 ea.	Thread M: 5
strength: approx. 28 kg			
OTNW-40		Price in EUR	Pot diameter D: 40,3 mm
Pot magnet with eyelet		1 pc. 10,07 ea.	Neck diameter d: 15,3 mm
white Ø 40,3 mm	from	3 pcs. 8,94 ea.	Pot height H1: 9,3 mm
powder-coated	from	10 pcs. 7,93 ea.	Total height without eyelet H2: 18,3 mm
thread M6	from	20 pcs. 7,44 ea.	Total height with eyelet H3: 59,3 mm
Weight: 120 g	from	40 pcs. 7,01 ea.	Thread M: 6
strength: approx. 50 kg			

Glue-in pot magnets

Distinctive feature: These magnets are glued into indentations when screwing is not possible.

Principle: The magnets are embedded in a steel pot. The steel pot increases the adhesive force of the magnet on direct contact with a thick iron surface. If there is no direct contact with the counterpart, or if the steel plate is thin, painted or rough, you won't be able to put as much strain on it.

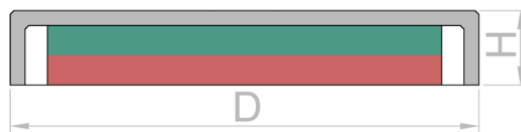

Shear force: The indicated adhesive force was measured perpendicular to the surface to which the magnet should stick. It takes a lot less strength to move the magnet sideways. Therefore, you won't be able to put as much strain on a pot magnet if you use it on a wall as opposed to using it on the ceiling.

© supermagnete.com

Rust: These magnets are not rust-proof and therefore intended for dry indoor use.

FGN-10 Glue-in pot magnet Ø 10 mm Weight: 2,5 g strength: approx. 2,2 kg	Price in EUR 5 pcs. 1,61 ea. from 15 pcs. 1,40 ea. from 40 pcs. 1,24 ea. from 80 pcs. 1,15 ea.	Pot diameter D: 10 mm Pot height H: 5 mm Magnetisation: N38 Coating: nickel-coated (Ni-Cu-Ni) Max. working temperature: 80°C Tolerance: +/- 0,1 mm
FGN-13 Glue-in pot magnet Ø 13 mm Weight: 4 g strength: approx. 3,2 kg	Price in EUR 5 pcs. 1,75 ea. from 15 pcs. 1,53 ea. from 40 pcs. 1,36 ea. from 80 pcs. 1,26 ea.	Pot diameter D: 13 mm Pot height H: 5 mm Magnetisation: N38 Coating: nickel-coated (Ni-Cu-Ni) Max. working temperature: 80°C Tolerance: +/- 0,1 mm
FGN-16 Glue-in pot magnet Ø 16 mm Weight: 7 g strength: approx. 5,5 kg	Price in EUR 5 pcs. 1,91 ea. from 15 pcs. 1,68 ea. from 40 pcs. 1,50 ea. from 80 pcs. 1,39 ea.	Pot diameter D: 16 mm Pot height H: 5 mm Magnetisation: N38 Coating: nickel-coated (Ni-Cu-Ni) Max. working temperature: 80°C Tolerance: +/- 0,1 mm
FGN-20 Glue-in pot magnet Ø 20 mm Weight: 14 g strength: approx. 9 kg	Price in EUR 1 pc. 3,38 ea. from 3 pcs. 2,96 ea. from 10 pcs. 2,58 ea. from 20 pcs. 2,40 ea. from 40 pcs. 2,24 ea.	Pot diameter D: 20 mm Pot height H: 7 mm Magnetisation: N38 Coating: nickel-coated (Ni-Cu-Ni) Max. working temperature: 80°C Tolerance: +/- 0,1 mm
FGN-25 Glue-in pot magnet Ø 25 mm Weight: 27 g strength: approx. 22 kg	Price in EUR 1 pc. 3,64 ea. from 3 pcs. 3,19 ea. from 10 pcs. 2,79 ea. from 20 pcs. 2,60 ea. from 40 pcs. 2,43 ea.	Pot diameter D: 25 mm Pot height H: 8 mm Magnetisation: N38 Coating: nickel-coated (Ni-Cu-Ni) Max. working temperature: 80°C Tolerance: +/- 0,1 mm
FGN-32 Glue-in pot magnet Ø 32 mm Weight: 43 g strength: approx. 34 kg	Price in EUR 1 pc. 4,48 ea. from 3 pcs. 3,95 ea. from 10 pcs. 3,48 ea. from 20 pcs. 3,25 ea. from 40 pcs. 3,04 ea.	Pot diameter D: 32 mm Pot height H: 8 mm Magnetisation: N38 Coating: nickel-coated (Ni-Cu-Ni) Max. working temperature: 80°C Tolerance: +/- 0,1 mm

FGN-42 Glue-in pot magnet Ø 42 mm Weight: 85 g strength: approx. 68 kg		Price in EUR	Pot diameter D: 42 mm
		1 pc.	7,49 ea.
	from	3 pcs.	6,67 ea.
	from	10 pcs.	5,94 ea.
	from	20 pcs.	5,59 ea.
	from	40 pcs.	5,27 ea.
			Pot height H: 9 mm
			Magnetisation: N38
			Coating: nickel-coated (Ni-Cu-Ni)
			Max. working temperature: 80°C
			Tolerance: +/- 0,1 mm
FGN-48 Glue-in pot magnet Ø 48 mm Weight: 130 g strength: approx. 85 kg		Price in EUR	Pot diameter D: 48 mm
		1 pc.	13,70 ea.
	from	3 pcs.	12,31 ea.
	from	10 pcs.	11,07 ea.
	from	20 pcs.	10,46 ea.
	from	40 pcs.	9,93 ea.
			Pot height H: 11,5 mm
			Magnetisation: N42
			Coating: nickel-coated (Ni-Cu-Ni)
			Max. working temperature: 80°C
			Tolerance: +/- 0,1 mm
FGN-60 Glue-in pot magnet Ø 60 mm Weight: 280 g strength: approx. 130 kg		Price in EUR	Pot diameter D: 60 mm
		1 pc.	23,35 ea.
	from	3 pcs.	21,12 ea.
	from	10 pcs.	19,13 ea.
	from	20 pcs.	18,16 ea.
	from	40 pcs.	17,30 ea.
			Pot height H: 15 mm
			Magnetisation: N42
			Coating: nickel-coated (Ni-Cu-Ni)
			Max. working temperature: 80°C
			Tolerance: +/- 0,1 mm

Pot magnets with internal thread

Distinctive feature: These magnets have a metric internal thread and can be fastened with objects with an external thread.

Principle: The magnets are embedded in a steel pot. The steel pot increases the adhesive force of the magnet on direct contact with a thick iron surface. If there is no direct contact with the counterpart, or if the steel plate is thin, painted or rough, you won't be able to put as much strain on it.

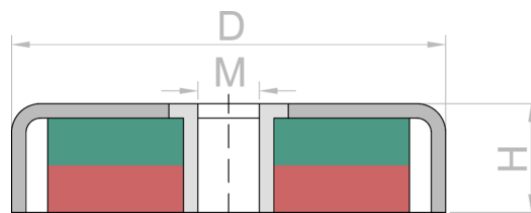

Shear force: The indicated adhesive force was measured perpendicular to the surface to which the magnet should stick. It takes a lot less strength to move the magnet sideways. Therefore, you won't be able to put as much strain on a pot magnet if you use it on a wall as opposed to using it on the ceiling.

Rust: These magnets are not rust-proof and therefore intended for dry indoor use.

ITN-10 Pot magnet with internal thread Ø 10 mm thread M3 Weight: 2,5 g strength: approx. 1,2 kg	Price in EUR 5 pcs. 1,77 ea. from 15 pcs. 1,53 ea. from 40 pcs. 1,34 ea. from 80 pcs. 1,23 ea.	Pot diameter D: 10 mm Pot height H: 4,5 mm Thread M: 3 Magnetisation: N38 Coating: nickel-coated (Ni-Cu-Ni) Max. working temperature: 80°C
ITN-13 Pot magnet with internal thread Ø 13 mm thread M3 Weight: 4,3 g strength: approx. 3 kg	Price in EUR 5 pcs. 1,90 ea. from 15 pcs. 1,64 ea. from 40 pcs. 1,45 ea. from 80 pcs. 1,33 ea.	Pot diameter D: 13 mm Pot height H: 4,5 mm Thread M: 3 Magnetisation: N38 Coating: nickel-coated (Ni-Cu-Ni) Max. working temperature: 80°C
ITN-16 Pot magnet with internal thread Ø 16 mm thread M4 Weight: 6,3 g strength: approx. 5,2 kg	Price in EUR 5 pcs. 2,09 ea. from 15 pcs. 1,82 ea. from 40 pcs. 1,61 ea. from 80 pcs. 1,48 ea.	Pot diameter D: 16 mm Pot height H: 4,5 mm Thread M: 4 Magnetisation: N38 Coating: nickel-coated (Ni-Cu-Ni) Max. working temperature: 80°C
ITN-20 Pot magnet with internal thread Ø 20 mm thread M4 Weight: 11 g strength: approx. 7,6 kg	Price in EUR 1 pc. 3,47 ea. from 3 pcs. 3,00 ea. from 10 pcs. 2,58 ea. from 20 pcs. 2,38 ea. from 40 pcs. 2,20 ea.	Pot diameter D: 20 mm Pot height H: 6 mm Thread M: 4 Magnetisation: N38 Coating: nickel-coated (Ni-Cu-Ni) Max. working temperature: 80°C
ITN-25 Pot magnet with internal thread MØ 25 mm thread M5 Weight: 21 g strength: approx. 14 kg	Price in EUR 1 pc. 4,30 ea. from 3 pcs. 3,74 ea. from 10 pcs. 3,24 ea. from 20 pcs. 2,99 ea. from 40 pcs. 2,78 ea.	Pot diameter D: 25 mm Pot height H: 7 mm Thread M: 5 Magnetisation: N38 Coating: nickel-coated (Ni-Cu-Ni) Max. working temperature: 80°C
ITN-32 Pot magnet with internal thread Ø 32 mm thread M6 Weight: 36 g strength: approx. 26 kg	Price in EUR 1 pc. 5,44 ea. from 3 pcs. 4,76 ea. from 10 pcs. 4,14 ea. from 20 pcs. 3,85 ea. from 40 pcs. 3,58 ea.	Pot diameter D: 32 mm Pot height H: 7 mm Thread M: 6 Magnetisation: N38 Coating: nickel-coated (Ni-Cu-Ni) Max. working temperature: 80°C

ITN-40 Pot magnet with internal thread 40 mm thread M6 Weight: 68 g strength: approx. 40 kg		Price in EUR	Pot diameter D: 40 mm
		1 pc.	9,95 ea.
	from	3 pcs.	8,78 ea.
	from	10 pcs.	7,74 ea.
	from	20 pcs.	7,23 ea.
	from	40 pcs.	6,78 ea.
			Pot height H: 8 mm
			Thread M: 6
			Magnetisation: N38
			Coating: nickel-coated (Ni-Cu-Ni)
			Max. working temperature: 80°C
ITN-48 Pot magnet with internal thread Ø 48 mm thread M8 Weight: 140 g strength: approx. 58 kg		Price in EUR	Pot diameter D: 48 mm
		1 pc.	11,90 ea.
	from	3 pcs.	10,53 ea.
	from	10 pcs.	9,31 ea.
	from	20 pcs.	8,71 ea.
	from	40 pcs.	8,18 ea.
			Pot height H: 11,5 mm
			Thread M: 8
			Magnetisation: N38
			Coating: nickel-coated (Ni-Cu-Ni)
			Max. working temperature: 80°C
ITN-60 Pot magnet with internal thread Ø 60 mm thread M8 Weight: 260 g strength: approx. 92 kg		Price in EUR	Pot diameter D: 60 mm
		1 pc.	22,59 ea.
	from	3 pcs.	20,14 ea.
	from	10 pcs.	17,96 ea.
	from	20 pcs.	16,89 ea.
	from	40 pcs.	15,96 ea.
			Pot height H: 15 mm
			Thread M: 8
			Magnetisation: N38
			Coating: nickel-coated (Ni-Cu-Ni)
			Max. working temperature: 80°C

Pot magnets with rubber coat

Distinctive feature: These magnets have a metric internal screw thread and can be fastened with objects with an external screw thread. The rubber coat protects the sensitive surface from scratches and increases the load capacity in shear direction.

Principle: The magnets are embedded in a steel pot. The steel pot increases the adhesive force of the magnet on direct contact with a thick iron surface. If there is no direct contact with the counterpart, or if the steel plate is thin, painted or rough, you won't be able to put as much strain on it.

Shear force: The indicated adhesive force was measured perpendicular to the surface to which the magnet should stick. Despite the rubber coat, it takes less strength to move the magnet sideways. Therefore, you won't be able to put as much strain on a pot magnet if you use it on a wall as opposed to using it on the ceiling.

Rust: The rubber protects the magnet from occasional moisture and splashing water. Permanent outside use, however, can lead to rusting.

<p>CMN-22 rubber coated pot magnet for cable mounting Ø 22 mm Weight: 12 g strength: approx. 3,9 kg</p>	<p>Price in EUR</p> <p>1 pc. 4,91 ea. from 3 pcs. 4,54 ea. from 10 pcs. 4,21 ea. from 20 pcs. 4,05 ea. from 40 pcs. 3,91 ea.</p>	<p>Rubberised neodymium pot magnets to which cables or pipes in various diameters can be attached directly or via cable ties.</p>
<p>CMN-31 rubber coated pot magnet for cable mounting Ø 31 mm Weight: 25 g strength: approx. 9,1 kg</p>	<p>Price in EUR</p> <p>1 pc. 5,74 ea. from 3 pcs. 5,32 ea. from 10 pcs. 4,95 ea. from 20 pcs. 4,77 ea. from 40 pcs. 4,61 ea.</p>	<p>Rubberised neodymium pot magnets to which cables or pipes in various diameters can be attached directly or via cable ties.</p>
<p>CMN-43 rubber coated pot magnet for cable mounting Ø 43 mm Weight: 31 g strength: approx. 10 kg</p>	<p>Price in EUR</p> <p>1 pc. 5,97 ea. from 3 pcs. 5,52 ea. from 10 pcs. 5,12 ea. from 20 pcs. 4,93 ea. from 40 pcs. 4,75 ea.</p>	<p>Rubberised neodymium pot magnets to which cables or pipes in various diameters can be attached directly or via cable ties.</p>
<p>ITNG-16 rubber-coated pot magnet with internal thread Ø 20 mm thread M4 Weight: 7,5 g strength: approx. 3,2 kg</p>	<p>Price in EUR</p> <p>5 pcs. 2,21 ea. from 15 pcs. 1,92 ea. from 40 pcs. 1,70 ea. from 80 pcs. 1,57 ea.</p>	<p>Covering: Rubber Diameter D: 20 mm Height H: 6 mm Thread M: 4 Magnetisation: N42 Max. working temperature: 80°C</p>
<p>ITNG-25 rubber-coated pot magnet with internal thread Ø 29 mm thread M5 Weight: 28 g strength: approx. 11 kg</p>	<p>Price in EUR</p> <p>1 pc. 5,60 ea. from 3 pcs. 4,89 ea. from 10 pcs. 4,27 ea. from 20 pcs. 3,96 ea. from 40 pcs. 3,69 ea.</p>	<p>Covering: Rubber Diameter D: 29 mm Height H: 8,5 mm Thread M: 5 Magnetisation: N42 Max. working temperature: 80°C</p>
<p>ITNG-32 rubber-coated pot magnet with internal thread Ø 36 mm thread M6 Weight: 49 g strength: approx. 21 kg</p>	<p>Price in EUR</p> <p>1 pc. 7,02 ea. from 3 pcs. 6,16 ea. from 10 pcs. 5,39 ea. from 20 pcs. 5,02 ea. from 40 pcs. 4,69 ea.</p>	<p>Covering: Rubber Diameter D: 36 mm Height H: 8,5 mm Thread M: 6 Magnetisation: N42 Max. working temperature: 80°C</p>

ITNG-40 rubber-coated pot magnet with internal thread Ø 45 mm thread M6 Weight: 80 g strength: approx. 31 kg		Price in EUR	Covering: Rubber
		1 pc.	11,13 ea.
	from	3 pcs.	9,84 ea.
	from	10 pcs.	8,69 ea.
	from	20 pcs.	8,12 ea.
	from	40 pcs.	7,63 ea.
			Diameter D: 45 mm
			Height H: 9,5 mm
			Thread M: 6
			Magnetisation: N42
			Max. working temperature: 80°C
ITNG-66 rubber-coated pot magnet with internal thread Ø 66 mm thread M6 Weight: 100 g strength: approx. 25 kg		Price in EUR	Covering: Rubber
		1 pc.	9,80 ea.
	from	3 pcs.	8,61 ea.
	from	10 pcs.	7,53 ea.
	from	20 pcs.	7,00 ea.
	from	40 pcs.	6,55 ea.
			Diameter D: 66 mm
			Height H: 8,5 mm
			Thread M: 6
			Magnetisation: N38
			Max. working temperature: 80°C

Pot magnets with cylindrical borehole screw-on

Distinctive feature: These magnets can be fastened with a screw without countersink.

Principle: The magnets are embedded in a steel pot. The steel pot increases the adhesive force of the magnet on direct contact with a thick iron surface. If there is no direct contact with the counterpart, or if the steel plate is thin, painted or rough, you won't be able to put as much strain on it.

Shear force: The indicated adhesive force was measured perpendicular to the surface to which the magnet should stick. It takes a lot less strength to move the magnet sideways. Therefore, you won't be able to put as much strain on a pot magnet if you use it on a wall as opposed to using it on the ceiling.

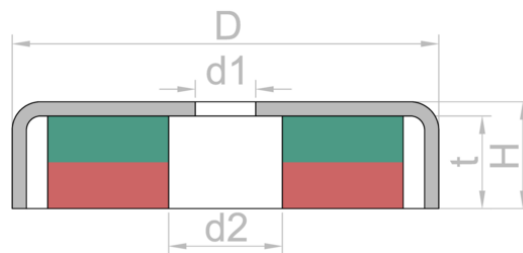

© supermagnete.com

Rust: These magnets are not rust-proof and therefore intended for dry indoor use.

ZTN-16 Pot magnet with cylindrical borehole Ø 16 mm Weight: 6 g strength: approx. 4 kg		Price in EUR	Pot diameter D: 16 mm
		5 pcs. 1,70 ea.	Pot height H: 5 mm
	from	15 pcs. 1,46 ea.	Borehole d1: 3,5 mm
	from	40 pcs. 1,29 ea.	Borehole d2: 6,5 mm
	from	80 pcs. 1,18 ea.	Depth t: 3,8 mm
			Tolerance: +/- 0,1 mm
ZTN-20 Pot magnet with cylindrical borehole Ø 20 mm Weight: 12 g strength: approx. 6 kg		Price in EUR	Pot diameter D: 20 mm
		1 pc. 2,94 ea.	Pot height H: 7 mm
	from	3 pcs. 2,54 ea.	Borehole d1: 4,5 mm
	from	10 pcs. 2,18 ea.	Borehole d2: 8 mm
	from	20 pcs. 2,00 ea.	Depth t: 5,5 mm
	from	40 pcs. 1,85 ea.	Tolerance: +/- 0,1 mm
ZTN-25 Pot magnet with cylindrical borehole Ø 25 mm Weight: 23 g strength: approx. 14 kg		Price in EUR	Pot diameter D: 25 mm
		1 pc. 3,81 ea.	Pot height H: 8 mm
	from	3 pcs. 3,31 ea.	Borehole d1: 5,5 mm
	from	10 pcs. 2,86 ea.	Borehole d2: 9 mm
	from	20 pcs. 2,65 ea.	Depth t: 6 mm
	from	40 pcs. 2,46 ea.	Tolerance: +/- 0,1 mm
ZTN-32 Pot magnet with cylindrical borehole Ø 32 mm Weight: 36 g strength: approx. 23 kg		Price in EUR	Pot diameter D: 32 mm
		1 pc. 5,04 ea.	Pot height H: 8 mm
	from	3 pcs. 4,41 ea.	Borehole d1: 5,5 mm
	from	10 pcs. 3,84 ea.	Borehole d2: 9 mm
	from	20 pcs. 3,57 ea.	Depth t: 5,5 mm
	from	40 pcs. 3,33 ea.	Tolerance: +/- 0,1 mm
ZTN-42 Pot magnet with cylindrical borehole Ø 42 mm Weight: 73 g strength: approx. 32 kg		Price in EUR	Pot diameter D: 42 mm
		1 pc. 7,78 ea.	Pot height H: 9 mm
	from	3 pcs. 6,86 ea.	Borehole d1: 6,5 mm
	from	10 pcs. 6,04 ea.	Borehole d2: 11 mm
	from	20 pcs. 5,63 ea.	Depth t: 6 mm
	from	40 pcs. 5,28 ea.	Tolerance: +/- 0,1 mm
ZTN-48 Pot magnet with cylindrical borehole Ø 48 mm Weight: 110 g strength: approx. 63 kg		Price in EUR	Pot diameter D: 48 mm
		1 pc. 12,39 ea.	Pot height H: 11,5 mm
	from	3 pcs. 10,99 ea.	Borehole d1: 8,5 mm
	from	10 pcs. 9,75 ea.	Borehole d2: 15 mm
	from	20 pcs. 9,14 ea.	Depth t: 8,5 mm
	from	40 pcs. 8,60 ea.	Tolerance: +/- 0,1 mm

ZTN-60

Pot magnet with cylindrical
borehole
Ø 60 mm
Weight: 240 g
strength: approx. 95 kg

Price in EUR

	1 pc.	22,43 ea.	Pot diameter D: 60 mm
	3 pcs.	20,05 ea.	Pot height H: 15 mm
from	10 pcs.	17,92 ea.	Borehole d1: 8,5 mm
from	20 pcs.	16,89 ea.	Borehole d2: 15 mm
from	40 pcs.	15,97 ea.	Depth t: 11,5 mm
			Tolerance: +/- 0,1 mm

Pot magnets with screw socket

Distinctive feature: These pot magnets have a screw socket, into which you can screw hooks, eyelets, etc. We also carry identical hook magnets as well as eyelet magnets.

Principle: The strong neodymium magnets are embedded in a steel pot. The steel pot increases the adhesive force of the magnet on direct contact with a thick iron surface. If there is no direct contact with the counterpart, or if the steel plate is thin, painted or rough, you won't be able to put as much strain on it.

Shear force: The indicated adhesive force was measured perpendicular to the surface to which the magnet should stick. It takes a lot less strength to move the magnet sideways. Therefore, you won't be able to put as much strain on a pot magnet if you use it on a wall as opposed to using it on the ceiling.

Rust: These magnets are not rust-proof and therefore intended for dry indoor use.

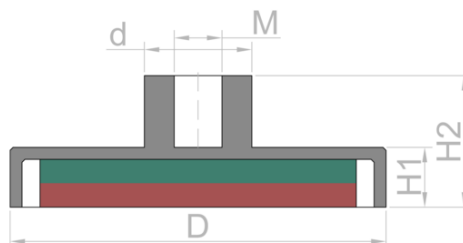

© supermagnete.com

TCN-10 Pot magnet with screw socket Ø 10 mm thread M3 Weight: 3,8 g strength: approx. 3 kg	Price in EUR 5 pcs. 1,53 ea. from 15 pcs. 1,33 ea. from 40 pcs. 1,18 ea. from 80 pcs. 1,09 ea.	Pot diameter D: 10 mm Neck diameter d: 5 mm Pot height H1: 4,5 mm Total height H2: 11,5 mm Thread M: 3 Tolerance: +/- 0,1 mm
TCN-13 Pot magnet with screw socket Ø 13 mm thread M3 Weight: 5,3 g strength: approx. 5 kg	Price in EUR 5 pcs. 1,71 ea. from 15 pcs. 1,50 ea. from 40 pcs. 1,34 ea. from 80 pcs. 1,24 ea.	Pot diameter D: 13 mm Neck diameter d: 5 mm Pot height H1: 4,5 mm Total height H2: 11,5 mm Thread M: 3 Tolerance: +/- 0,1 mm
TCN-16 Pot magnet with screw socket Ø 16 mm thread M4 Weight: 7,7 g strength: approx. 8 kg	Price in EUR 5 pcs. 1,93 ea. from 15 pcs. 1,69 ea. from 40 pcs. 1,52 ea. from 80 pcs. 1,41 ea.	Pot diameter D: 16 mm Neck diameter d: 6 mm Pot height H1: 4,5 mm Total height H2: 11,5 mm Thread M: 4 Tolerance: +/- 0,1 mm
TCN-20 Pot magnet with screw socket Ø 20 mm thread M4 Weight: 17 g strength: approx. 13 kg	Price in EUR 1 pc. 3,08 ea. from 3 pcs. 2,69 ea. from 10 pcs. 2,35 ea. from 20 pcs. 2,18 ea. from 40 pcs. 2,03 ea.	Pot diameter D: 20 mm Neck diameter d: 8 mm Pot height H1: 6 mm Total height H2: 13 mm Thread M: 4 Tolerance: +/- 0,1 mm
TCNG-22 rubber-coated pot magnet with screw socket Ø 22 mm thread M4 Weight: 13 g strength: approx. 5,9 kg	Price in EUR 5 pcs. 2,97 ea. from 15 pcs. 2,58 ea. from 40 pcs. 2,40 ea. from 80 pcs. 2,10 ea.	Covering: Rubber (Santoprene TPV) Diameter D: 22 mm Height H: 6 mm Thread M: 4 Magnetisation: N42 Max. working temperature: 80°C
TCNG-31 rubber-coated pot magnet with screw socket Ø 31 mm thread M4 Weight: 22 g strength: approx. 9 kg	Price in EUR 1 pc. 3,44 ea. from 3 pcs. 3,01 ea. from 10 pcs. 2,64 ea. from 20 pcs. 2,45 ea. from 40 pcs. 2,29 ea.	Covering: Rubber (Santoprene TPV) Diameter D: 31 mm Height H: 6 mm Thread M: 4 Magnetisation: N42 Max. working temperature: 80°C

<p>TCNG-43 rubber-coated pot magnet with screw socket Ø 43 mm thread M4 Weight: 30 g strength: approx. 10 kg</p>	<p>Price in EUR</p> <p>1 pc. 5,60 ea. from 3 pcs. 4,91 ea. from 10 pcs. 4,29 ea. from 20 pcs. 3,99 ea. from 40 pcs. 3,73 ea.</p>	<p>Covering: Rubber (Santoprene TPV) Diameter D: 43 mm Height H: 6 mm Thread M: 4 Magnetisation: N42 Max. working temperature: 80°C</p>
<p>TCNG-66 rubber-coated pot magnet with screw socket Ø 66 mm thread M5 Weight: 110 g strength: approx. 25 kg</p>	<p>Price in EUR</p> <p>1 pc. 9,80 ea. from 3 pcs. 8,60 ea. from 10 pcs. 7,53 ea. from 20 pcs. 7,00 ea. from 40 pcs. 6,55 ea.</p>	<p>Covering: Rubber (Santoprene TPV) Diameter D: 66 mm Height H: 8,5 mm Thread M: 5 Magnetisation: N38 Max. working temperature: 80°C</p>
<p>TCN-25 Pot magnet with screw socket Ø 25 mm thread M4 Weight: 27 g strength: approx. 18 kg</p>	<p>Price in EUR</p> <p>1 pc. 3,68 ea. from 3 pcs. 3,23 ea. from 10 pcs. 2,83 ea. from 20 pcs. 2,64 ea. from 40 pcs. 2,47 ea.</p>	<p>Pot diameter D: 25 mm Neck diameter d: 8 mm Pot height H1: 7 mm Total height H2: 14 mm Thread M: 4 Tolerance: +/- 0,1 mm</p>
<p>TCN-32 Pot magnet with screw socket Ø 32 mm thread M5 Weight: 44 g strength: approx. 30 kg</p>	<p>Price in EUR</p> <p>1 pc. 4,67 ea. from 3 pcs. 4,12 ea. from 10 pcs. 3,64 ea. from 20 pcs. 3,40 ea. from 40 pcs. 3,19 ea.</p>	<p>Pot diameter D: 32 mm Neck diameter d: 10 mm Pot height H1: 7 mm Total height H2: 15,5 mm Thread M: 5 Tolerance: +/- 0,1 mm</p>
<p>TCN-40 Pot magnet with screw socket Ø 40 mm thread M6 Weight: 97 g strength: approx. 55 kg</p>	<p>Price in EUR</p> <p>1 pc. 9,40 ea. from 3 pcs. 8,40 ea. from 10 pcs. 7,51 ea. from 20 pcs. 7,08 ea. from 40 pcs. 6,70 ea.</p>	<p>Pot diameter D: 40 mm Neck diameter d: 15 mm Pot height H1: 9 mm Total height H2: 18 mm Thread M: 6 Tolerance: +/- 0,1 mm</p>
<p>TCN-50 Pot magnet with screw socket Ø 50 mm thread M8 Weight: 140 g strength: approx. 75 kg</p>	<p>Price in EUR</p> <p>1 pc. 14,18 ea. from 3 pcs. 12,75 ea. from 10 pcs. 11,47 ea. from 20 pcs. 10,85 ea. from 40 pcs. 10,30 ea.</p>	<p>Pot diameter D: 50 mm Neck diameter d: 15 mm Pot height H1: 9 mm Total height H2: 18 mm Thread M: 8 Tolerance: +/- 0,1 mm</p>
<p>TCN-63 Pot magnet with screw socket Ø 63 mm thread M8 Weight: 240 g strength: approx. 110 kg</p>	<p>Price in EUR</p> <p>1 pc. 19,81 ea. from 3 pcs. 17,89 ea. from 10 pcs. 16,17 ea. from 20 pcs. 15,33 ea. from 40 pcs. 14,59 ea.</p>	<p>Pot diameter D: 63 mm Neck diameter d: 18 mm Pot height H1: 10 mm Total height H2: 22 mm Thread M: 8 Tolerance: +/- 0,1 mm</p>

Pot magnets & magnet systems with ferrite magnets

Distinctive feature: These magnets are ferrite and not neodymium magnets. They have therefore a lower adhesive force and are larger. But are cheaper than neodymium magnets and can be used outside as well.

Principle: The magnets are embedded in a steel pot. The steel pot increases the adhesive force of the magnet on direct contact with a thick iron surface. If there is no direct contact with the counterpart, or if the steel plate is thin, painted or rough, you won't be able to put as much strain on it.

Shear force: The indicated adhesive force was measured perpendicular to the surface to which the magnet should stick. It takes a lot less strength to move the magnet sideways. Therefore, you won't be able to put as much strain on a pot magnet if you use it on a wall as opposed to using it on the ceiling.

Rust: These magnets are rust-proof and can therefore be used outside and in wet surroundings as well. The pots surrounding the magnets, however, may develop surface rust over time.

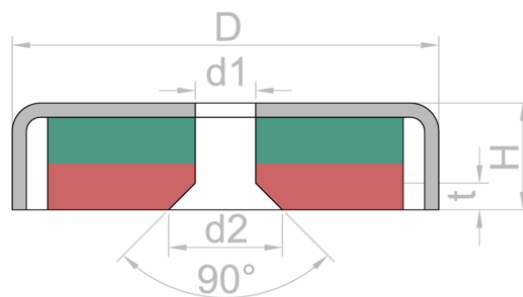

© supermagnete.com

<p>SF-MBF-01 Magnet with mount for poster frame ferrite magnet system in plastic housing with vertical adapter Weight: 42 g</p>	<p>Price in EUR 5 pcs. 1,52 ea. from 15 pcs. 1,32 ea. from 40 pcs. 1,16 ea. from 80 pcs. 1,07 ea.</p>	<p>Practical ferrite magnet holder with vertical (upward facing) adapter for attaching sign frames to ferromagnetic surfaces. The magnetic holder allows easy and flexible positioning of poster frames in no time.</p>
<p>SF-MBF-02 Magnet with mount for poster frame ferrite magnet system in plastic housing with horizontal adapter Weight: 43 g</p>	<p>Price in EUR 5 pcs. 1,52 ea. from 15 pcs. 1,32 ea. from 40 pcs. 1,16 ea. from 80 pcs. 1,07 ea.</p>	<p>Practical ferrite magnetic holder with horizontal adapter for attaching sign frames to ferromagnetic surfaces. The magnetic holder enables easy and flexible positioning of poster frames in no time at all.</p>
<p>SF-MBH-01 Magnetic banner hanger, straight with two plastic hooks with push button 180° rotatable Weight: 150 g</p>	<p>Price in EUR 1 pc. 6,56 ea. from 3 pcs. 5,67 ea. from 10 pcs. 4,88 ea. from 20 pcs. 4,49 ea. from 40 pcs. 4,15 ea.</p>	<p>Length: 71 mm Length mast: 285 mm Width: 38 mm Height 1: 16 mm Height 2: 32 mm Hook length: 25 mm</p>
<p>SF-MBH-02 Magnetic banner hanger, angled with two plastic hooks with push button 180° rotatable Weight: 150 g</p>	<p>Price in EUR 1 pc. 6,74 ea. from 3 pcs. 5,83 ea. from 10 pcs. 5,02 ea. from 20 pcs. 4,62 ea. from 40 pcs. 4,27 ea.</p>	<p>This magnetic banner hanger consists of a ferrite magnet system and an attached angled arm with two plastic hooks. Very versatile as a point-of-purchase display in retail settings.</p>
<p>SF-MGS-01 Gripper sign holder magnetic with horizontal, flush gripper made of plastic Weight: 63 g strength: approx. 10 kg</p>	<p>Price in EUR 5 pcs. 1,95 ea. from 15 pcs. 1,71 ea. from 40 pcs. 1,53 ea. from 80 pcs. 1,42 ea.</p>	<p>Sturdy magnetic sign holder with ferrite channel magnet and large clip made of transparent PVC. Perfect for retail or warehouse use.</p>
<p>SF-MGS-02 Gripper sign holder magnetic with vertical, upward pointing gripper made of plastic Weight: 62 g strength: approx. 10 kg</p>	<p>Price in EUR 5 pcs. 1,95 ea. from 15 pcs. 1,71 ea. from 40 pcs. 1,53 ea. from 80 pcs. 1,42 ea.</p>	<p>Sturdy magnetic sign holder with ferrite channel magnet and short clip made of transparent PVC. Perfect for retail and warehouse use.</p>

<p>SF-MGS-03 Gripper sign holder magnetic with vertical, upward pointing gripper made of plastic Weight: 62 g strength: approx. 10 kg</p>	<p>Price in EUR</p> <p>1 pc. 2,53 ea. from 3 pcs. 2,20 ea. from 10 pcs. 1,90 ea. from 20 pcs. 1,76 ea. from 40 pcs. 1,63 ea.</p>	<p>Sturdy magnetic sign holder with ferrite channel magnet and flexible clip made of transparent PVC. Perfect for retail or warehouse use.</p>
<p>SF-MGS-04 Gripper sign holder magnetic with vertical, upward pointing gripper made of plastic Weight: 62 g strength: approx. 10 kg</p>	<p>Price in EUR</p> <p>1 pc. 2,53 ea. from 3 pcs. 2,20 ea. from 10 pcs. 1,90 ea. from 20 pcs. 1,76 ea. from 40 pcs. 1,63 ea.</p>	<p>Sturdy magnetic sign holder with ferrite channel magnet and large clip made of transparent PVC. Perfect for retail or warehouse use.</p>
<p>SF-MRF-01 Rotating holder magnetic ferrite magnet system in plastic housing with push button 180° rotatable Weight: 130 g</p>	<p>Price in EUR</p> <p>1 pc. 3,71 ea. from 3 pcs. 3,27 ea. from 10 pcs. 2,88 ea. from 20 pcs. 2,69 ea. from 40 pcs. 2,52 ea.</p>	<p>Length: 71 mm Length 2: 88 mm Width: 38 mm Height 1: 16 mm Height 2: 105 mm Opening for poster frame: 8,5 mm</p>
<p>CSF-25 Ferrite pot magnet with counterbore Ø 25 mm Weight: 16 g strength: approx. 2,2 kg</p>	<p>Price in EUR</p> <p>5 pcs. 1,53 ea. from 15 pcs. 1,33 ea. from 40 pcs. 1,17 ea. from 80 pcs. 1,08 ea.</p>	<p>Pot diameter D: 25 mm Pot height H: 7 mm Borehole d1: 5,5 mm Borehole d2: 11,7 mm Countersink t: 3,1 mm Magnetisation: Y30BH</p>
<p>CSF-40 Ferrite pot magnet with counterbore Ø 40 mm Weight: 50 g strength: approx. 16 kg</p>	<p>Price in EUR</p> <p>1 pc. 2,74 ea. from 3 pcs. 2,38 ea. from 10 pcs. 2,06 ea. from 20 pcs. 1,90 ea. from 40 pcs. 1,76 ea.</p>	<p>Pot diameter D: 40 mm Pot height H: 8 mm Borehole d1: 5,5 mm Borehole d2: 11,7 mm Countersink t: 3,1 mm Magnetisation: Y30BH</p>
<p>CSF-48 Ferrite pot magnet with counterbore Ø 48 mm Weight: 110 g strength: approx. 23 kg</p>	<p>Price in EUR</p> <p>1 pc. 4,01 ea. from 3 pcs. 3,54 ea. from 10 pcs. 3,12 ea. from 20 pcs. 2,92 ea. from 40 pcs. 2,74 ea.</p>	<p>Pot diameter D: 48 mm Pot height H: 11,5 mm Borehole d1: 8,5 mm Borehole d2: 18,12 mm Countersink t: 4,81 mm Magnetisation: Y30BH</p>
<p>CSF-60 Ferrite pot magnet with counterbore Ø 60 mm Weight: 210 g strength: approx. 36 kg</p>	<p>Price in EUR</p> <p>1 pc. 5,47 ea. from 3 pcs. 4,87 ea. from 10 pcs. 4,33 ea. from 20 pcs. 4,07 ea. from 40 pcs. 3,83 ea.</p>	<p>Pot diameter D: 60 mm Pot height H: 15 mm Borehole d1: 8,5 mm Borehole d2: 18,12 mm Countersink t: 4,81 mm Magnetisation: Y30BH</p>
<p>ITF-25 Ferrite pot magnet with internal thread M4 Ø 25 mm Weight: 18 g strength: approx. 3,6 kg</p>	<p>Price in EUR</p> <p>1 pc. 3,14 ea. from 3 pcs. 2,75 ea. from 10 pcs. 2,40 ea. from 20 pcs. 2,23 ea. from 40 pcs. 2,08 ea.</p>	<p>Ferrite pot magnets with metric internal thread and heat resistance of up to 200°C.</p>
<p>ITF-32 Ferrite pot magnet with internal thread M4 Ø 32 mm Weight: 29 g strength: approx. 7,6 kg</p>	<p>Price in EUR</p> <p>1 pc. 3,33 ea. from 3 pcs. 2,92 ea. from 10 pcs. 2,56 ea. from 20 pcs. 2,38 ea. from 40 pcs. 2,22 ea.</p>	<p>Ferrite pot magnets with metric internal thread and heat resistance of up to 200°C.</p>

<p>ITF-40 Ferrite pot magnet with internal thread M4 Ø 40 mm Weight: 53 g strength: approx. 9,1 kg</p>	<p>Price in EUR 1 pc. 4,04 ea. from 3 pcs. 3,56 ea. from 10 pcs. 3,14 ea. from 20 pcs. 2,93 ea. from 40 pcs. 2,75 ea.</p>	<p>Ferrite pot magnets with metric internal thread and heat resistance of up to 200°C.</p>
<p>ITF-50 Ferrite pot magnet with internal thread M8 Ø 50 mm Weight: 94 g strength: approx. 17 kg</p>	<p>Price in EUR 1 pc. 4,95 ea. from 3 pcs. 4,39 ea. from 10 pcs. 3,89 ea. from 20 pcs. 3,64 ea. from 40 pcs. 3,43 ea.</p>	<p>Ferrite pot magnets with metric internal thread and heat resistance of up to 200°C.</p>
<p>MPH-34 Magnet with mount for poster frame ferrite magnet system in plastic housing with adjustable adapter 180° pivoting angle Weight: 36 g strength: approx. 10 kg</p>	<p>Price in EUR 1 pc. 1,76 ea. from 3 pcs. 1,65 ea. from 10 pcs. 1,55 ea. from 20 pcs. 1,51 ea. from 40 pcs. 1,47 ea.</p>	<p>This high-quality ferrite magnet holder for poster frames features a solid plastic housing and a sturdy 180° swivelling adapter.</p>
<p>WS-HOOK-01 Sandwich magnet with hook ferrite magnet system in plastic housing rectangular, 53 x 27,5 mm Weight: 53 g strength: approx. 15 kg</p>	<p>Price in EUR 1 pc. 2,99 ea. from 3 pcs. 2,58 ea. from 10 pcs. 2,22 ea. from 20 pcs. 2,05 ea. from 40 pcs. 1,89 ea.</p>	<p>Simple ferrite hook magnet with a white plastic housing features a slim and sturdy design, which makes it ideal for hanging up promotional material for product presentation.</p>
<p>WS-HOOK-02 Sandwich magnet with loop ferrite magnet system in plastic housing square, 58 x 58 mm Weight: 130 g strength: approx. 30 kg</p>	<p>Price in EUR 1 pc. 5,49 ea. from 3 pcs. 4,79 ea. from 10 pcs. 4,16 ea. from 20 pcs. 3,86 ea. from 40 pcs. 3,59 ea.</p>	<p>Strong ferrite eyelet magnet with a white plastic housing is ideal for discreetly hanging up promotional material for product presentation.</p>

Screw hooks & eyelet bolts

<p>STH-4 screw hook 4 mm inner diameter steel, nickel-coated thread M3 Weight: 2 g</p>	<p>Price in EUR 10 pcs. 0,30 ea.</p>	<p>Height H: 19,05 mm Hook opening width a: 3,5 mm Hook inside diameter b: 4 mm Length thread h: 5 mm Thread M: 3 Tolerance: +/- 0,5 mm</p>
<p>STH-5.5 screw hook 5,5 mm inner diameter steel, nickel-coated thread M4 Weight: 3 g</p>	<p>Price in EUR 10 pcs. 0,50 ea.</p>	<p>Height H: 22 mm Hook opening width a: 4 mm Hook inside diameter b: 5,5 mm Length thread h: 6 mm Thread M: 4 Tolerance: +/- 0,5 mm</p>
<p>STH-14 screw hook 14 mm inner diameter steel, nickel-coated thread M5 Weight: 8 g</p>	<p>Price in EUR 5 pcs. 0,90 ea.</p>	<p>Height H: 38 mm Hook opening width a: 11 mm Hook inside diameter b: 14 mm Length thread h: 8 mm Thread M: 5 Tolerance: +/- 0,5 mm</p>
<p>STH-22 screw hook 22 mm inner diameter steel, nickel-coated thread M8 Weight: 34 g</p>	<p>Price in EUR 1 pc. 1,10 ea.</p>	<p>Height H: 53,5 mm Hook opening width a: 17 mm Hook inside diameter b: 22 mm Length thread h: 9 mm Thread M: 8 Tolerance: +/- 0,5 mm</p>
<p>STH-26 screw hook 26 mm inner diameter steel, nickel-coated thread M6 Weight: 19 g</p>	<p>Price in EUR 1 pc. 1,30 ea.</p>	<p>Height H: 50 mm Hook opening width a: 19 mm Hook inside diameter b: 26 mm Length thread h: 8 mm Thread M: 6 Tolerance: +/- 0,5 mm</p>
<p>STE-4 threaded eyelet bolt 4 mm inner diameter steel, nickel-coated thread M4 Weight: 3 g</p>	<p>Price in EUR 10 pcs. 0,30 ea.</p>	<p>Height H: 22 mm Hook inside diameter b: 4 mm Length thread h: 6 mm Thread M: 4 Tolerance: +/- 0,5 mm Coating: Nickel (Ni)</p>
<p>STE-11 threaded eyelet bolt 11 mm inner diameter steel, nickel-coated thread M5 Weight: 9 g</p>	<p>Price in EUR 5 pcs. 0,90 ea.</p>	<p>Height H: 38 mm Hook inside diameter b: 11 mm Length thread h: 8 mm Thread M: 5 Tolerance: +/- 0,5 mm Coating: Nickel (Ni)</p>
<p>STE-19 threaded eyelet bolt 19 mm inner diameter steel, nickel-coated thread M6 Weight: 16 g</p>	<p>Price in EUR 1 pc. 1,10 ea.</p>	<p>Height H: 50 mm Hook inside diameter b: 19 mm Length thread h: 8 mm Thread M: 6 Tolerance: +/- 0,5 mm Coating: Nickel (Ni)</p>

Deep pot magnets with neodymium magnets

<p>BMN-10 deep pot magnet Ø 10 mm with smooth housing Weight: 12 g strength: approx. 2,4 kg</p>	<p>Price in EUR</p> <p>5 pcs. 2,62 ea. from 15 pcs. 2,27 ea. from 40 pcs. 2,01 ea. from 120 pcs. 1,76 ea.</p>	<p>Diameter: 10 mm Height: 20 mm Diameter magnet: 7,5 mm Height magnet: 4 mm Tolerance: +/- 0,2 mm Material magnet: Neodymium-NiCuNi plated</p>
<p>BMN-13 deep pot magnet Ø 13 mm with smooth housing Weight: 21 g strength: approx. 6 kg</p>	<p>Price in EUR</p> <p>5 pcs. 2,76 ea. from 15 pcs. 2,39 ea. from 40 pcs. 2,12 ea. from 120 pcs. 1,86 ea.</p>	<p>Diameter: 13 mm Height: 20 mm Diameter magnet: 9 mm Height magnet: 4 mm Material magnet: Neodymium-NiCuNi plated Tolerance: +/- 0,2 mm</p>
<p>BMN-16 deep pot magnet Ø 16 mm with smooth housing Weight: 31 g strength: approx. 9 kg</p>	<p>Price in EUR</p> <p>5 pcs. 2,87 ea. from 15 pcs. 2,50 ea. from 40 pcs. 2,21 ea. from 120 pcs. 1,94 ea.</p>	<p>Diameter: 16 mm Height: 20 mm Diameter magnet: 12,3 mm Height magnet: 2 mm Tolerance: +/- 0,2 mm Material magnet: Neodymium-NiCuNi plated</p>
<p>BMN-20 deep pot magnet Ø 20 mm with smooth housing Weight: 61 g strength: approx. 13 kg</p>	<p>Price in EUR</p> <p>1 pc. 4,21 ea. from 3 pcs. 3,64 ea. from 10 pcs. 3,13 ea. from 40 pcs. 2,65 ea. from 80 pcs. 2,44 ea.</p>	<p>Diameter: 20 mm Height: 25 mm Diameter magnet: 15 mm Height magnet: 2 mm Tolerance: +/- 0,2 mm Material magnet: Neodymium-NiCuNi plated</p>
<p>BMN-25 deep pot magnet Ø 25 mm with smooth housing Weight: 130 g strength: approx. 19 kg</p>	<p>Price in EUR</p> <p>1 pc. 5,71 ea. from 3 pcs. 4,97 ea. from 10 pcs. 4,29 ea. from 40 pcs. 3,65 ea.</p>	<p>Diameter: 25 mm Height: 35 mm Diameter magnet: 18,3 mm Height magnet: 2 mm Tolerance: +/- 0,2 mm Material magnet: Neodymium-NiCuNi plated</p>
<p>BMN-32 deep pot magnet Ø 32 mm with smooth housing Weight: 130 g strength: approx. 34 kg</p>	<p>Price in EUR</p> <p>1 pc. 8,14 ea. from 3 pcs. 7,11 ea. from 10 pcs. 6,17 ea. from 40 pcs. 5,29 ea.</p>	<p>Diameter: 32 mm Height: 40 mm Diameter magnet: 24 mm Height magnet: 2 mm Tolerance: +/- 0,2 mm Material magnet: Neodymium-NiCuNi plated</p>
<p>BMN-IT-10 deep pot magnet Ø 10 mm with internal thread thread M4 Weight: 9 g strength: approx. 2,4 kg</p>	<p>Price in EUR</p> <p>5 pcs. 2,82 ea. from 15 pcs. 2,45 ea. from 40 pcs. 2,17 ea. from 120 pcs. 1,90 ea.</p>	<p>Diameter: 10 mm Height: 16 mm Diameter magnet: 7,5 mm Height magnet: 4 mm Thread M: 4 Tolerance: +/- 0,2 mm</p>
<p>BMN-IT-13 deep pot magnet Ø 13 mm with internal thread thread M4 Weight: 20 g strength: approx. 6 kg</p>	<p>Price in EUR</p> <p>5 pcs. 2,98 ea. from 15 pcs. 2,59 ea. from 40 pcs. 2,30 ea.</p>	<p>Diameter: 13 mm Height: 20 mm Diameter magnet: 9 mm Height magnet: 4 mm Thread M: 4 Tolerance: +/- 0,2 mm</p>

<p>BMN-IT-16 deep pot magnet Ø 16 mm with internal thread thread M4 Weight: 30 g strength: approx. 9 kg</p>	<p>Price in EUR</p> <p>5 pcs. 3,04 ea. from 15 pcs. 2,65 ea. from 40 pcs. 2,35 ea.</p>	<p>Diameter: 16 mm Height: 20 mm Diameter magnet: 12,3 mm Height magnet: 2 mm Thread M: 4 Tolerance: +/- 0,2 mm</p>
<p>BMN-IT-20 deep pot magnet Ø 20 mm with internal thread thread M6 Weight: 58 g strength: approx. 13 kg</p>	<p>Price in EUR</p> <p>1 pc. 4,42 ea. from 3 pcs. 3,83 ea. from 10 pcs. 3,29 ea. from 40 pcs. 2,79 ea. from 80 pcs. 2,57 ea.</p>	<p>Diameter: 20 mm Height: 25 mm Diameter magnet: 15 mm Height magnet: 2 mm Thread M: 6 Tolerance: +/- 0,2 mm</p>
<p>BMN-IT-25 deep pot magnet Ø 25 mm with internal thread thread M6 Weight: 130 g strength: approx. 19 kg</p>	<p>Price in EUR</p> <p>1 pc. 5,74 ea. from 3 pcs. 5,00 ea. from 10 pcs. 4,31 ea. from 40 pcs. 3,67 ea.</p>	<p>Diameter: 25 mm Height: 35 mm Diameter magnet: 18,3 mm Height magnet: 2 mm Thread M: 6 Tolerance: +/- 0,2 mm</p>
<p>BMN-IT-32 deep pot magnet Ø 32 mm with internal thread thread M8 Weight: 240 g strength: approx. 34 kg</p>	<p>Price in EUR</p> <p>1 pc. 8,51 ea. from 3 pcs. 7,44 ea. from 10 pcs. 6,46 ea. from 40 pcs. 5,54 ea.</p>	<p>Diameter: 32 mm Height: 40 mm Diameter magnet: 24 mm Height magnet: 2 mm Thread M: 8 Tolerance: +/- 0,2 mm</p>
<p>BMN-PP-10 deep pot magnet Ø 10 mm with stud stud Ø 4 mm Weight: 13 g strength: approx. 2,4 kg</p>	<p>Price in EUR</p> <p>5 pcs. 2,77 ea. from 15 pcs. 2,41 ea. from 40 pcs. 2,13 ea. from 120 pcs. 1,87 ea.</p>	<p>Diameter: 10 mm Height 1: 20 mm Height 2: 28 mm Diameter stem: 4 mm Diameter magnet: 7,5 mm Height magnet: 4 mm</p>
<p>BMN-PP-13 deep pot magnet Ø 13 mm with stud stud Ø 4 mm Weight: 21 g strength: approx. 6 kg</p>	<p>Price in EUR</p> <p>5 pcs. 2,97 ea. from 15 pcs. 2,58 ea. from 40 pcs. 2,29 ea.</p>	<p>Diameter: 13 mm Height 1: 20 mm Height 2: 28 mm Diameter stem: 4 mm Diameter magnet: 9 mm Height magnet: 4 mm</p>
<p>BMN-PP-16 deep pot magnet Ø 16 mm with stud stud Ø 5 mm Weight: 31 g strength: approx. 9 kg</p>	<p>Price in EUR</p> <p>5 pcs. 3,11 ea. from 15 pcs. 2,70 ea. from 40 pcs. 2,40 ea.</p>	<p>Diameter: 16 mm Height 1: 20 mm Height 2: 28 mm Diameter stem: 5 mm Diameter magnet: 12,3 mm Height magnet: 2 mm</p>
<p>BMN-PP-20 deep pot magnet Ø 20 mm with stud stud Ø 6 mm Weight: 61 g strength: approx. 13 kg</p>	<p>Price in EUR</p> <p>1 pc. 4,57 ea. from 3 pcs. 3,96 ea. from 10 pcs. 3,41 ea. from 40 pcs. 2,89 ea. from 80 pcs. 2,67 ea.</p>	<p>Diameter: 20 mm Height 1: 25 mm Height 2: 33 mm Diameter stem: 6 mm Diameter magnet: 15 mm Height magnet: 2 mm</p>
<p>BMN-PP-25 deep pot magnet Ø 25 mm with stud stud Ø 8 mm Weight: 130 g strength: approx. 19 kg</p>	<p>Price in EUR</p> <p>1 pc. 6,09 ea. from 3 pcs. 5,30 ea. from 10 pcs. 4,58 ea. from 40 pcs. 3,91 ea.</p>	<p>Diameter: 25 mm Height 1: 35 mm Height 2: 45 mm Diameter stem: 8 mm Diameter magnet: 18,3 mm Height magnet: 2 mm</p>

<p>BMN-PP-32 deep pot magnet Ø 32 mm with stud stud Ø 10 mm Weight: 250 g strength: approx. 34 kg</p>	<p>Price in EUR</p> <p>1 pc. 8,99 ea.</p> <p>from 3 pcs. 7,87 ea.</p> <p>from 10 pcs. 6,84 ea.</p> <p>from 40 pcs. 5,87 ea.</p>	<p>Diameter: 32 mm Height 1: 40 mm Height 2: 50 mm Diameter stem: 10 mm Diameter magnet: 24 mm Height magnet: 2 mm</p>
<p>BMN-TS-10 deep pot magnet Ø 10 mm with threaded stud thread M4 Weight: 11 g strength: approx. 2,4 kg</p>	<p>Price in EUR</p> <p>5 pcs. 2,86 ea.</p> <p>from 15 pcs. 2,49 ea.</p> <p>from 40 pcs. 2,20 ea.</p> <p>from 120 pcs. 1,93 ea.</p>	<p>Diameter: 10 mm Height 1: 20 mm Height 2: 28 mm Diameter magnet: 7,5 mm Height magnet: 4 mm Thread M: 4</p>
<p>BMN-TS-13 deep pot magnet Ø 13 mm with threaded stud thread M4 Weight: 20 g strength: approx. 6 kg</p>	<p>Price in EUR</p> <p>5 pcs. 3,01 ea.</p> <p>from 15 pcs. 2,61 ea.</p> <p>from 40 pcs. 2,32 ea.</p>	<p>Diameter: 13 mm Height 1: 20 mm Height 2: 28 mm Diameter magnet: 9 mm Height magnet: 4 mm Thread M: 4</p>
<p>BMN-TS-16 deep pot magnet Ø 16 mm with threaded stud thread M4 Weight: 30 g strength: approx. 9 kg</p>	<p>Price in EUR</p> <p>5 pcs. 3,15 ea.</p> <p>from 15 pcs. 2,75 ea.</p> <p>from 40 pcs. 2,44 ea.</p>	<p>Diameter: 16 mm Height 1: 20 mm Height 2: 30 mm Diameter magnet: 12,3 mm Height magnet: 2 mm Thread M: 4</p>
<p>BMN-TS-20 deep pot magnet Ø 20 mm with threaded stud thread M6 Weight: 58 g strength: approx. 13 kg</p>	<p>Price in EUR</p> <p>1 pc. 4,46 ea.</p> <p>from 3 pcs. 3,87 ea.</p> <p>from 10 pcs. 3,33 ea.</p> <p>from 40 pcs. 2,82 ea.</p> <p>from 80 pcs. 2,60 ea.</p>	<p>Diameter: 20 mm Height 1: 25 mm Height 2: 35 mm Diameter magnet: 15 mm Height magnet: 2 mm Thread M: 6</p>
<p>BMN-TS-25 deep pot magnet Ø 25 mm with threaded stud thread M6 Weight: 130 g strength: approx. 19 kg</p>	<p>Price in EUR</p> <p>1 pc. 5,93 ea.</p> <p>from 3 pcs. 5,16 ea.</p> <p>from 10 pcs. 4,46 ea.</p> <p>from 40 pcs. 3,80 ea.</p>	<p>Diameter: 25 mm Height 1: 35 mm Height 2: 45 mm Diameter magnet: 18,3 mm Height magnet: 2 mm Thread M: 6</p>
<p>BMN-TS-32 deep pot magnet Ø 32 mm with threaded stud thread M8 Weight: 240 g strength: approx. 34 kg</p>	<p>Price in EUR</p> <p>1 pc. 8,84 ea.</p> <p>from 3 pcs. 7,73 ea.</p> <p>from 10 pcs. 6,72 ea.</p> <p>from 40 pcs. 5,76 ea.</p>	<p>Diameter: 32 mm Height 1: 40 mm Height 2: 52 mm Diameter magnet: 24 mm Height magnet: 2 mm Thread M: 8</p>

Nuts & Bolts

<p>M-HN-A2M4 Hex nut M4 made of stainless steel A2 100 pieces per package Weight: 69 g/set</p>	<p>Price in EUR 1 set 6,04/set</p>	<p>These hexagonal nuts with M4 thread are made of stainless steel type A2 and conform to standard DIN 934. The nuts with strength class 70 are shipped in small boxes of 100 pieces each.</p>
<p>M-HN-A2M5 Hex nut M5 made of stainless steel A2 100 pieces per package Weight: 110 g/set</p>	<p>Price in EUR 1 set 7,05/set</p>	<p>These hexagonal nuts with M5 thread are made of stainless steel type A2 and conform to standard DIN 934. The nuts with strength class 70 are shipped in small boxes of 100 pieces each.</p>
<p>M-HN-A2M6 Hex nut M6 made of stainless steel A2 100 pieces per package Weight: 220 g/set</p>	<p>Price in EUR 1 set 10,65/set</p>	<p>These hexagonal nuts with M6 thread are made of stainless steel type A2 and conform to standard DIN 934. The nuts with strength class 70 are shipped in small boxes of 100 pieces each.</p>
<p>M-HN-A2M8 Hex nut M8 made of stainless steel A2 100 pieces per package Weight: 470 g/set</p>	<p>Price in EUR 1 set 17,91/set</p>	<p>These hexagonal nuts with M8 thread are made of stainless steel type A2 and conform to standard DIN 934. The nuts with strength class 70 are shipped in small boxes of 100 pieces each.</p>
<p>M-RB-M6 Eyebolt M6 made of steel C15 zinc-plated Weight: 58 g</p>	<p>Price in EUR 1 pc. 2,92 ea.</p>	<p>Eyebolt with M6 thread made of galvanised steel and with a right-angle tensile strength of 80 kg. The perfect accessory for our pot magnets with screw sockets.</p>
<p>M-RB-M8 Eyebolt M8 made of steel C15 zinc-plated Weight: 58 g</p>	<p>Price in EUR 1 pc. 2,92 ea.</p>	<p>Eyebolt with M8 thread made of galvanised steel and with a right-angle tensile strength of 140 kg. The perfect accessory for our pot magnets with screw sockets.</p>
<p>M-RN-M6 Ring nut M6 made of steel C15 zinc-plated Weight: 50 g</p>	<p>Price in EUR 1 pc. 2,92 ea.</p>	<p>Ring nut with M6 thread made of galvanised steel and with a right-angle tensile strength of 80 kg. The perfect accessory for our pot magnets with threaded studs.</p>
<p>M-RN-M8 Ring nut M8 made of steel C15 zinc-plated Weight: 52 g</p>	<p>Price in EUR 1 pc. 2,92 ea.</p>	<p>Ring nut with M8 thread made of galvanised steel and with a right-angle tensile strength of 140 kg. The perfect accessory for our pot magnets with threaded studs.</p>

M-TN-10M8

T-nut M8
nut for T-slots, slot nominal
dimension 10 mm
black
Weight: 12 g

Price in EUR
1 pc. 5,81 ea.

These black T-nuts with M8 thread are made of heat-treated steel (class 10) and conform to DIN standard 508 extended.

Plastic handles / grips

<p>M-PAH-EM5 Plastic handle with threaded stud M5 black Weight: 13 g</p>	<p>Price in EUR 1 pc. 5,10 ea. from 3 pcs. 4,80 ea. from 10 pcs. 4,20 ea.</p>	<p>This tapered plastic handle with galvanised threaded stud M5 is the perfect accessory for our pot magnets with internal thread. You can find links to matching magnets on our website.</p>
<p>M-PAH-EM6 Plastic handle with threaded stud M6 black Weight: 31 g</p>	<p>Price in EUR 1 pc. 5,80 ea. from 3 pcs. 5,30 ea. from 10 pcs. 4,70 ea.</p>	<p>This tapered plastic handle with galvanised threaded stud M6 is the perfect accessory for our pot magnets with internal thread. You can find links to matching magnets on our website.</p>
<p>M-PAH-EM8 Plastic handle with threaded stud M8 black Weight: 35 g</p>	<p>Price in EUR 1 pc. 6,50 ea. from 3 pcs. 6,10 ea. from 10 pcs. 5,20 ea.</p>	<p>This tapered plastic handle with galvanised threaded stud M8 is the perfect accessory for our pot magnets with internal thread. You can find links to matching magnets on our website.</p>
<p>M-PAH-IM5 Plastic handle with internal thread M5 black Weight: 7 g</p>	<p>Price in EUR 1 pc. 4,60 ea. from 3 pcs. 4,30 ea. from 10 pcs. 3,90 ea.</p>	<p>This small tapered plastic handle with internal thread M5 is the perfect accessory for our pot magnets with threaded stud. You can find links to matching magnets on our website.</p>
<p>M-PAH-IM6 Plastic handle with internal thread M6 Black Weight: 10 g</p>	<p>Price in EUR 1 pc. 6,90 ea. from 3 pcs. 6,30 ea. from 10 pcs. 5,70 ea.</p>	<p>Glossy black plastic handle with internal thread M6 and slightly rounded ends. You can find links to matching pot magnets on our website.</p>
<p>M-PAH-IM8 Plastic handle with internal thread M8 black Weight: 18 g</p>	<p>Price in EUR 1 pc. 9,90 ea. from 3 pcs. 9,50 ea. from 10 pcs. 8,90 ea.</p>	<p>Glossy black plastic handle with internal thread M8 and slightly rounded ends. You can find links to matching pot magnets on our website.</p>

Screw-on counterparts for magnets

These are not magnets! These metal discs are suitable as counterpart for our magnets, e.g. hook or block magnets with borehole.

They can be easily screwed onto non-magnetic surfaces with a countersunk bolt.

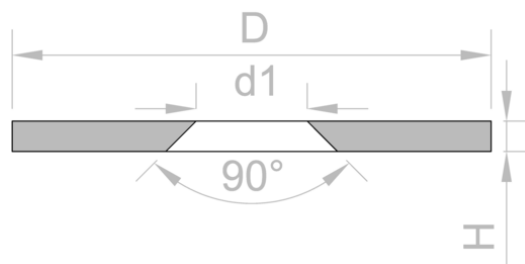

© supermagnete.com

<p>MSD-17 Metal disc with an edge and counterbore M3 Inner diameter 17 mm as a counterpart to magnets, not a magnet! Weight: 4 g</p>	<p>Price in EUR</p> <p>10 pcs. 1,31 ea. from 20 pcs. 1,24 ea. from 40 pcs. 1,18 ea.</p>	<p>These metal discs with an edge and sinkhole drilling are perfect magnetic bases for our pot magnets or magnetic hooks.</p>
<p>MSD-21 Metal disc with an edge and counterbore M3 Inner diameter 21 mm as a counterpart to magnets, not a magnet! Weight: 5,5 g</p>	<p>Price in EUR</p> <p>10 pcs. 1,42 ea. from 20 pcs. 1,34 ea. from 40 pcs. 1,28 ea.</p>	<p>These metal discs with an edge and sinkhole drilling are perfect magnetic bases for our pot magnets or magnetic hooks.</p>
<p>MSD-26 Metal disc with an edge and counterbore M4 Inner diameter 26 mm as a counterpart to magnets, not a magnet! Weight: 13 g</p>	<p>Price in EUR</p> <p>10 pcs. 1,53 ea. from 20 pcs. 1,45 ea. from 40 pcs. 1,38 ea.</p>	<p>These metal discs with an edge and sinkhole drilling are perfect magnetic bases for our pot magnets or magnetic hooks.</p>
<p>MSD-33 Metal disc with an edge and counterbore M4 Inner diameter 33 mm as a counterpart to magnets, not a magnet! Weight: 19 g</p>	<p>Price in EUR</p> <p>10 pcs. 1,64 ea. from 20 pcs. 1,56 ea. from 40 pcs. 1,48 ea.</p>	<p>These metal discs with an edge and sinkhole drilling are perfect magnetic bases for our pot magnets or magnetic hooks.</p>
<p>MD-12 Metal disc with counterbore Ø 12 mm as a counterpart to magnets not a magnet! Weight: 0,5 g</p>	<p>Price in EUR</p> <p>10 pcs. 0,23 ea. from 40 pcs. 0,19 ea. from 80 pcs. 0,17 ea. from 160 pcs. 0,15 ea.</p>	<p>Diameter D: 12 mm Height H: 1,5 mm Borehole d1: 5,5 mm Borehole d2: 8,5 mm Coating: Nickel (Ni)</p>
<p>MD-15 Metal disc with counterbore Ø 15 mm as a counterpart to magnets not a magnet! Weight: 1,2 g</p>	<p>Price in EUR</p> <p>10 pcs. 0,24 ea. from 40 pcs. 0,20 ea. from 80 pcs. 0,18 ea. from 160 pcs. 0,16 ea.</p>	<p>Diameter D: 15 mm Height H: 1,5 mm Borehole d1: 5,5 mm Borehole d2: 8,5 mm Coating: Nickel (Ni)</p>

<p>MD-18 Metal disc with counterbore Ø 18 mm as a counterpart to magnets not a magnet! Weight: 2,5 g</p>	<p>Price in EUR</p> <p>10 pcs. 0,25 ea. from 40 pcs. 0,21 ea. from 80 pcs. 0,19 ea. from 160 pcs. 0,17 ea.</p>	<p>Diameter D: 18 mm Height H: 1,5 mm Borehole d1: 5,5 mm Borehole d2: 8,5 mm Coating: Nickel (Ni)</p>
<p>MD-23 Metal disc with counterbore Ø 23 mm as a counterpart to magnets not a magnet! Weight: 4 g</p>	<p>Price in EUR</p> <p>10 pcs. 0,37 ea. from 40 pcs. 0,32 ea. from 80 pcs. 0,30 ea. from 160 pcs. 0,28 ea.</p>	<p>Diameter D: 23 mm Height H: 1,5 mm Borehole d1: 5,5 mm Borehole d2: 8,5 mm Coating: Nickel (Ni)</p>
<p>MD-27 Metal disc with counterbore Ø 27 mm as a counterpart to magnets not a magnet! Weight: 12 g</p>	<p>Price in EUR</p> <p>10 pcs. 0,44 ea. from 40 pcs. 0,38 ea. from 80 pcs. 0,36 ea. from 160 pcs. 0,34 ea.</p>	<p>Diameter D: 27 mm Height H: 3 mm Borehole d1: 5,7 mm Borehole d2: 11,7 mm Coating: Nickel (Ni)</p>
<p>MD-34 Metal disc with counterbore Ø 34 mm as a counterpart to magnets not a magnet! Weight: 19 g</p>	<p>Price in EUR</p> <p>5 pcs. 0,52 ea. from 15 pcs. 0,46 ea. from 40 pcs. 0,42 ea. from 80 pcs. 0,39 ea.</p>	<p>Diameter D: 34 mm Height H: 3 mm Borehole d1: 5,7 mm Borehole d2: 11,7 mm Coating: Nickel (Ni)</p>
<p>MD-42 Metal disc with counterbore Ø 42 mm as a counterpart to magnets not a magnet! Weight: 31 g</p>	<p>Price in EUR</p> <p>5 pcs. 0,71 ea. from 15 pcs. 0,64 ea. from 40 pcs. 0,59 ea. from 80 pcs. 0,55 ea.</p>	<p>Diameter D: 42 mm Height H: 3 mm Borehole d1: 5,7 mm Borehole d2: 11,7 mm Coating: Nickel (Ni)</p>
<p>MD-50 Metal disc with counterbore Ø 50 mm as a counterpart to magnets not a magnet! Weight: 44 g</p>	<p>Price in EUR</p> <p>5 pcs. 0,76 ea. from 15 pcs. 0,68 ea. from 40 pcs. 0,63 ea. from 80 pcs. 0,60 ea.</p>	<p>Diameter D: 50 mm Height H: 3 mm Borehole d1: 5,7 mm Borehole d2: 11,7 mm Coating: Nickel (Ni)</p>
<p>MD-52 Metal disc with counterbore Ø 52 mm as a counterpart to magnets not a magnet! Weight: 49 g</p>	<p>Price in EUR</p> <p>5 pcs. 0,84 ea. from 15 pcs. 0,77 ea. from 40 pcs. 0,71 ea. from 80 pcs. 0,67 ea.</p>	<p>Diameter D: 52 mm Height H: 3 mm Borehole d1: 5,7 mm Borehole d2: 11,7 mm Coating: Nickel (Ni)</p>
<p>MD-62 Metal disc with counterbore Ø 62 mm as a counterpart to magnets not a magnet! Weight: 69 g</p>	<p>Price in EUR</p> <p>5 pcs. 0,98 ea. from 15 pcs. 0,89 ea. from 40 pcs. 0,82 ea. from 80 pcs. 0,78 ea.</p>	<p>Diameter D: 62 mm Height H: 3 mm Borehole d1: 5,7 mm Borehole d2: 11,7 mm Coating: Nickel (Ni)</p>
<p>MD-65 Metal disc with counterbore Ø 65 mm as a counterpart to magnets not a magnet! Weight: 76 g</p>	<p>Price in EUR</p> <p>5 pcs. 1,08 ea. from 15 pcs. 0,99 ea. from 40 pcs. 0,92 ea. from 80 pcs. 0,87 ea.</p>	<p>Diameter D: 65 mm Height H: 3 mm Borehole d1: 5,7 mm Borehole d2: 11,7 mm Coating: Nickel (Ni)</p>

<p>MC-15-15-03 Metal plate with counterbore 15 x 15 x 3 mm as a counterpart to magnets not a magnet! Weight: 3,9 g</p>	<p>Price in EUR 10 pcs. 0,28 ea. from 40 pcs. 0,23 ea. from 80 pcs. 0,21 ea. from 160 pcs. 0,20 ea.</p>	<p>These metal plates are the ideal base for countersunk block magnets. They can be easily screwed onto non-magnetic surfaces with a countersunk head-screw.</p>
<p>MC-20-20-03 Metal plate with counterbore 20 x 20 x 3 mm as a counterpart to magnets not a magnet! Weight: 8 g</p>	<p>Price in EUR 10 pcs. 0,35 ea. from 40 pcs. 0,30 ea. from 80 pcs. 0,27 ea. from 160 pcs. 0,26 ea.</p>	<p>These metal plates are the ideal base for countersunk block magnets. They can be easily screwed onto non-magnetic surfaces with a countersunk head-screw.</p>
<p>MC-40-20-03 Metal plate with counterbore 40 x 20 x 3 mm as a counterpart to magnets not a magnet! Weight: 16 g</p>	<p>Price in EUR 5 pcs. 0,47 ea. from 15 pcs. 0,41 ea. from 40 pcs. 0,37 ea. from 80 pcs. 0,35 ea.</p>	<p>These metal plates are the ideal base for countersunk block magnets. They scan be easily screwed onto non-magnetic surfaces with two countersunk head-screws.</p>
<p>MC-40-40-03 Metal plate with counterbore 40 x 40 x 3 mm as a counterpart to magnets not a magnet! Weight: 35 g</p>	<p>Price in EUR 5 pcs. 0,59 ea. from 15 pcs. 0,52 ea. from 40 pcs. 0,46 ea. from 80 pcs. 0,43 ea.</p>	<p>These metal plates are the ideal base for countersunk block magnets. They scan be easily screwed onto non-magnetic surfaces with two countersunk head-screws.</p>
<p>MC-60-20-03 Metal plate with counterbore 60 x 20 x 3 mm as a counterpart to magnets not a magnet! Weight: 25 g</p>	<p>Price in EUR 5 pcs. 0,64 ea. from 15 pcs. 0,58 ea. from 40 pcs. 0,53 ea. from 80 pcs. 0,50 ea.</p>	<p>These metal plates are the ideal base for countersunk block magnets. They can be easily screwed onto non-magnetic surfaces with two countersunk head-screws.</p>
<p>MC-80-20-03 Metal plate with counterbore 80 x 20 x 3 mm as a counterpart to magnets not a magnet! Weight: 35 g</p>	<p>Price in EUR 5 pcs. 0,81 ea. from 15 pcs. 0,72 ea. from 40 pcs. 0,65 ea. from 80 pcs. 0,61 ea.</p>	<p>These metal plates are the ideal base for countersunk block magnets. They scan be easily screwed onto non-magnetic surfaces with two countersunk head-screws.</p>

Glue-on counterparts for magnets

These metal discs are suitable as counterpart for our magnets, e.g. disc or hook magnets. Thanks to the self-adhesive back, they can be easily attached to smooth surfaces.

<p>PAS-10 Metal disc self-adhesive Ø 10 mm as a counterpart to magnets not a magnet! Weight: 1,2 g</p>	<p>Price in EUR</p> <p>10 pcs. 0,28 ea. from 40 pcs. 0,24 ea. from 80 pcs. 0,22 ea. from 160 pcs. 0,20 ea.</p>	<p>Diameter D: 10 mm Height H: 2 mm Coating: Zinc (Zn) Tolerance: +/- 0,1 mm Adhesive: 3M, No. 9888T Shelf life adhesive: 12 months (approx.)</p>
<p>PAS-10-W Metal disc self-adhesive white Ø 10 mm as a counterpart to magnets not a magnet! Weight: 1,3 g</p>	<p>Price in EUR</p> <p>10 pcs. 0,33 ea. from 40 pcs. 0,28 ea. from 80 pcs. 0,26 ea. from 160 pcs. 0,24 ea.</p>	<p>Diameter D: 10,3 mm Height H: 2,3 mm Coating: Zinc (Zn), spray-painted Tolerance: +/- 0,2 mm Adhesive: 3M, No. 9888T Shelf life adhesive: 12 months (approx.)</p>
<p>PAS-13 Metal disc self-adhesive Ø 13 mm as a counterpart to magnets not a magnet! Weight: 2,1 g</p>	<p>Price in EUR</p> <p>10 pcs. 0,30 ea. from 40 pcs. 0,25 ea. from 80 pcs. 0,23 ea. from 160 pcs. 0,21 ea.</p>	<p>Diameter D: 13 mm Height H: 2 mm Coating: Zinc (Zn) Tolerance: +/- 0,1 mm Adhesive: 3M, No. 9888T Shelf life adhesive: 12 months (approx.)</p>
<p>PAS-13-W Metal disc self-adhesive white Ø 13 mm as a counterpart to magnets not a magnet! Weight: 2,2 g</p>	<p>Price in EUR</p> <p>10 pcs. 0,34 ea. from 40 pcs. 0,29 ea. from 80 pcs. 0,27 ea. from 160 pcs. 0,25 ea.</p>	<p>Diameter D: 13,3 mm Height H: 2,3 mm Coating: Zinc (Zn), spray-painted Tolerance: +/- 0,2 mm Adhesive: 3M, No. 9888T Shelf life adhesive: 12 months (approx.)</p>
<p>PAS-16 Metal disc self-adhesive Ø 16 mm as a counterpart to magnets not a magnet! Weight: 3,2 g</p>	<p>Price in EUR</p> <p>10 pcs. 0,31 ea. from 40 pcs. 0,26 ea. from 80 pcs. 0,24 ea. from 160 pcs. 0,22 ea.</p>	<p>Diameter D: 16 mm Height H: 2 mm Coating: Zinc (Zn) Tolerance: +/- 0,1 mm Adhesive: 3M, No. 9888T Shelf life adhesive: 12 months (approx.)</p>
<p>PAS-16-W Metal disc self-adhesive white Ø 16 mm as a counterpart to magnets not a magnet! Weight: 3,3 g</p>	<p>Price in EUR</p> <p>10 pcs. 0,38 ea. from 40 pcs. 0,32 ea. from 80 pcs. 0,30 ea. from 160 pcs. 0,28 ea.</p>	<p>Diameter D: 16,3 mm Height H: 2,3 mm Coating: Zinc (Zn), spray-painted Tolerance: +/- 0,2 mm Adhesive: 3M, No. 9888T Shelf life adhesive: 12 months (approx.)</p>
<p>PAS-20 Metal disc self-adhesive Ø 20 mm as a counterpart to magnets not a magnet! Weight: 5 g</p>	<p>Price in EUR</p> <p>10 pcs. 0,32 ea. from 40 pcs. 0,27 ea. from 80 pcs. 0,25 ea. from 160 pcs. 0,24 ea.</p>	<p>Diameter D: 20 mm Height H: 2 mm Coating: Zinc (Zn) Tolerance: +/- 0,1 mm Adhesive: 3M, No. 9888T Shelf life adhesive: 12 months (approx.)</p>
<p>PAS-20-W Metal disc self-adhesive white Ø 20 mm as a counterpart to magnets not a magnet! Weight: 5,1 g</p>	<p>Price in EUR</p> <p>10 pcs. 0,40 ea. from 40 pcs. 0,34 ea. from 80 pcs. 0,32 ea. from 160 pcs. 0,30 ea.</p>	<p>Diameter D: 20,3 mm Height H: 2,3 mm Coating: Zinc (Zn), spray-painted Tolerance: +/- 0,2 mm Adhesive: 3M, No. 9888T Shelf life adhesive: 12 months (approx.)</p>

Rubber caps & silicone discs: Skid and scratch protection all in one

These rubber caps can be put over the bottom side of pot magnets to protect delicate surfaces, plus the friction increases the load capacity of the magnet in shear direction.

<p>M-SIL-10 Silicone discs Ø 10 mm self-adhesive 136 per set Weight: 25 g/set</p>	<p>Price in EUR 1 set 3,99/set</p>	<p>Material: Silicone Diameter: 10 mm Thickness: 0,5 mm Pieces per sheet: 136 pieces Adhesive: 3M, No. 9080A Shelf life adhesive: 24 months (approx.)</p>
<p>M-SIL-12 Silicone discs Ø 12 mm self-adhesive 98 per set Weight: 25 g/set</p>	<p>Price in EUR 1 set 3,49/set</p>	<p>Material: Silicone Diameter: 12 mm Thickness: 0,5 mm Pieces per sheet: 98 pieces Adhesive: 3M, No. 9080A Shelf life adhesive: 24 months (approx.)</p>
<p>M-SIL-15 Silicone discs Ø 15 mm self-adhesive 60 per set Weight: 25 g/set</p>	<p>Price in EUR 1 set 2,99/set</p>	<p>Material: Silicone Diameter: 15 mm Thickness: 0,5 mm Pieces per sheet: 60 pieces Adhesive: 3M, No. 9080A Shelf life adhesive: 24 months (approx.)</p>
<p>M-SIL-20 Silicone discs Ø 20 mm self-adhesive 36 per set Weight: 25 g/set</p>	<p>Price in EUR 1 set 2,49/set</p>	<p>Material: Silicone Diameter: 20 mm Thickness: 0,5 mm Pieces per sheet: 36 pieces Adhesive: 3M, No. 9080A Shelf life adhesive: 24 months (approx.)</p>
<p>PAR-11 Rubber caps Ø 11 mm to protect surfaces Weight: 0,16 g</p>	<p>Price in EUR 10 pcs. 0,20 ea. from 40 pcs. 0,16 ea. from 80 pcs. 0,15 ea. from 160 pcs. 0,14 ea.</p>	<p>Diameter D: 11 mm Height H: 3 mm Material strength t: 0,5 mm Max. working temperature: 100°C</p>
<p>PAR-14 Rubber caps Ø 14 mm to protect surfaces Weight: 0,2 g</p>	<p>Price in EUR 10 pcs. 0,21 ea. from 40 pcs. 0,17 ea. from 80 pcs. 0,16 ea. from 160 pcs. 0,15 ea.</p>	<p>Diameter D: 14 mm Height H: 3 mm Material strength t: 0,5 mm Max. working temperature: 100°C</p>
<p>PAR-17 Rubber caps Ø 17 mm to protect surfaces Weight: 0,3 g</p>	<p>Price in EUR 10 pcs. 0,23 ea. from 40 pcs. 0,20 ea. from 80 pcs. 0,18 ea. from 160 pcs. 0,17 ea.</p>	<p>Diameter D: 17 mm Height H: 3 mm Material strength t: 0,5 mm Max. working temperature: 100°C</p>
<p>PAR-21 Rubber caps Ø 21 mm to protect surfaces Weight: 0,5 g</p>	<p>Price in EUR 10 pcs. 0,23 ea. from 40 pcs. 0,19 ea. from 80 pcs. 0,18 ea. from 160 pcs. 0,17 ea.</p>	<p>Diameter D: 21 mm Height H: 5 mm Material strength t: 0,5 mm Max. working temperature: 100°C</p>

<p>PAR-26 Rubber caps Ø 26 mm to protect surfaces Weight: 0,7 g</p>	<p>Price in EUR 10 pcs. 0,24 ea. from 40 pcs. 0,20 ea. from 80 pcs. 0,18 ea. from 160 pcs. 0,17 ea.</p>	<p>Diameter D: 26 mm Height H: 5 mm Material strength t: 0,5 mm Max. working temperature: 100°C</p>
<p>PAR-33 Rubber caps Ø 33 mm to protect surfaces Weight: 1 g</p>	<p>Price in EUR 5 pcs. 0,31 ea. from 15 pcs. 0,27 ea. from 40 pcs. 0,24 ea. from 80 pcs. 0,23 ea.</p>	<p>Diameter D: 33 mm Height H: 5 mm Material strength t: 0,5 mm Max. working temperature: 100°C</p>
<p>PAR-41 Rubber caps Ø 41 mm to protect surfaces Weight: 1,6 g</p>	<p>Price in EUR 5 pcs. 0,33 ea. from 15 pcs. 0,29 ea. from 40 pcs. 0,26 ea. from 80 pcs. 0,24 ea.</p>	<p>Diameter D: 41 mm Height H: 6 mm Material strength t: 0,5 mm</p>
<p>PAR-49 Rubber caps Ø 49 mm to protect surfaces Weight: 2 g</p>	<p>Price in EUR 5 pcs. 0,35 ea. from 15 pcs. 0,30 ea. from 40 pcs. 0,27 ea. from 80 pcs. 0,25 ea.</p>	<p>Diameter D: 49 mm Height H: 6 mm Material strength t: 0,5 mm Max. working temperature: 100°C</p>
<p>PAR-51 Rubber caps Ø 51 mm to protect surfaces Weight: 2,2 g</p>	<p>Price in EUR 5 pcs. 0,38 ea. from 15 pcs. 0,33 ea. from 40 pcs. 0,30 ea. from 80 pcs. 0,28 ea.</p>	<p>Diameter D: 51 mm Height H: 6 mm Material strength t: 0,5 mm Max. working temperature: 100°C</p>
<p>PAR-61 Rubber caps Ø 61 mm to protect surfaces Weight: 3 g</p>	<p>Price in EUR 5 pcs. 0,38 ea. from 15 pcs. 0,34 ea. from 40 pcs. 0,31 ea. from 80 pcs. 0,29 ea.</p>	<p>Diameter D: 61 mm Height H: 6 mm Material strength t: 0,5 mm Max. working temperature: 100°C</p>
<p>PAR-64 Rubber caps Ø 64 mm to protect surfaces Weight: 3,5 g</p>	<p>Price in EUR 5 pcs. 0,39 ea. from 15 pcs. 0,35 ea. from 40 pcs. 0,31 ea. from 80 pcs. 0,29 ea.</p>	<p>Diameter D: 64 mm Height H: 6 mm Material strength t: 0,5 mm Max. working temperature: 100°C</p>
<p>PAR-76 Rubber caps Ø 76 mm to protect surfaces Weight: 3 g</p>	<p>Price in EUR 5 pcs. 0,46 ea. from 15 pcs. 0,43 ea. from 40 pcs. 0,41 ea. from 80 pcs. 0,40 ea.</p>	<p>Diameter D: 76 mm Height H: 6 mm Material strength t: 0,5 mm Max. working temperature: 100°C</p>

Practical magnetic accessories for the warehouse

WS-LHM-125 Lifting magnet MaxX 125 maximum load 125 kg for flat and round stock safety factor 3:1 Weight: 3,7 kg	Price in EUR 1 pc. 374,85 ea.	The lifting magnet MaxX 125 features a rotating hook and can hold loads of up to 125 kg. Detailed specifications and safety tips can be found in our online shop.
WS-LHM-250 Lifting magnet MaxX 250 maximum load 250 kg for flat and round stock Safety factor 3:1 Weight: 6 kg	Price in EUR 1 pc. 464,10 ea.	The lifting magnet MaxX 250 features a fixed hook and can hold loads of up to 250 kg. Detailed specifications and safety tips can be found in our online shop.
WS-LHM-300E Lifting magnet MaxX 300E maximum load 300 kg for flat and round stock Safety factor 3:1 Weight: 6 kg	Price in EUR 1 pc. 535,50 ea.	The lifting magnet MaxX 300E features a fixed hook and can hold loads of up to 300 kg. Detailed specifications and safety tips can be found in our online shop.
WS-LHM-500 Lifting magnet MaxX 500 maximum load 500 kg for flat and round stock Safety factor 3:1 Weight: 15 kg	Price in EUR 1 pc. 690,20 ea.	The lifting magnet MaxX 500 features a rotating hook and can hold loads of up to 500 kg. You can find detailed specifications and safety tips in our online shop.

Magnets for POS and exhibition stand construction

SF-FRM-A3 Sign frame A3 made of plastic with rounded corners u-pocket included Weight: 150 g	Price in EUR 5 pcs. 3,02 ea. from 15 pcs. 2,76 ea. from 40 pcs. 2,57 ea. from 80 pcs. 2,45 ea.	Practical sign frame in A3 format, made of sturdy plastic and available in various colours. U-shaped pocket inside made of hard PVC (not anti-reflective) is included.
SF-FRM-A4 Sign frame A4 made of plastic with rounded corners u-pocket included Weight: 100 g	Price in EUR 5 pcs. 2,42 ea. from 15 pcs. 2,22 ea. from 40 pcs. 2,07 ea. from 80 pcs. 1,98 ea.	A practical sign frame in A4 format, made of sturdy plastic and available in various colours. U-shaped pocket inside made of hard PVC (not anti-reflective) is included.
SF-FRM-A5 Sign frame A5 made of plastic with rounded corners u-pocket included Weight: 63 g	Price in EUR 5 pcs. 1,87 ea. from 15 pcs. 1,70 ea. from 40 pcs. 1,58 ea. from 80 pcs. 1,50 ea.	A practical sign frame in A5 format, made of sturdy plastic and available in various colours. U-shaped pocket inside made of hard PVC (not anti-reflective) is included.

Magnetic tape - for labelling, highlighting and marking

You can use these strong magnetised tapes (magnetic strips) in various widths and many different colours to label steel shelves and metal cupboards, etc. They are a colourful eye-catcher on a whiteboard or on magnetic paint. You can cut the tapes to the desired size with regular scissors, and they are easy to write and print on.

<p>MT-07 Coloured magnetic tape 7 mm for labelling and cutting rolls of 1 m Weight: 26 g/m</p>	<p>Price in EUR</p> <p>1 m 2,15/m</p> <p>from 3 m 1,81/m</p> <p>from 10 m 1,51/m</p> <p>from 20 m 1,36/m</p> <p>from 40 m 1,23/m</p>	<p>This magnetic tape is 7 mm wide and available in four different colours. It can easily be cut to the desired length with standard scissors and labelled. It will be delivered in strips of 1 m.</p>
<p>MT-10 Coloured magnetic tape 10 mm for labelling and cutting rolls of 1 m Weight: 37 g/m</p>	<p>Price in EUR</p> <p>1 m 2,20/m</p> <p>from 3 m 1,91/m</p> <p>from 10 m 1,65/m</p> <p>from 20 m 1,52/m</p> <p>from 40 m 1,40/m</p>	<p>The magnetic band MT-10 is 10 mm wide and available in many different colours. You can cut it to the desired size with regular scissors and write on it. The cut length is 1 metre.</p>
<p>MT-20 Coloured magnetic tape 20 mm for labelling and cutting rolls of 1 m Weight: 74 g/m</p>	<p>Price in EUR</p> <p>1 m 2,77/m</p> <p>from 3 m 2,38/m</p> <p>from 10 m 2,04/m</p> <p>from 20 m 1,87/m</p> <p>from 40 m 1,72/m</p>	<p>The magnetic band MT-20 is 20 mm wide and available in many different colours. You can cut it to the desired size with regular scissors and write on it. The cut length is 1 metre.</p>
<p>MT-30 Coloured magnetic tape 30 mm for labelling and cutting rolls of 1 m Weight: 110 g/m</p>	<p>Price in EUR</p> <p>1 m 3,50/m</p> <p>from 3 m 2,98/m</p> <p>from 10 m 2,51/m</p> <p>from 20 m 2,28/m</p> <p>from 40 m 2,08/m</p>	<p>The magnetic band MT-30 is 30 mm wide and available in many different colours. You can cut it to the desired size with regular scissors and write on it. The cut length is 1 metre.</p>
<p>MT-40 Coloured magnetic tape 40 mm for labelling and cutting rolls of 1 m Weight: 150 g/m</p>	<p>Price in EUR</p> <p>1 m 3,90/m</p> <p>from 3 m 3,36/m</p> <p>from 10 m 2,87/m</p> <p>from 20 m 2,64/m</p> <p>from 40 m 2,43/m</p>	<p>The magnetic band MT-40 is 40 mm wide and available in many different colours. You can cut it to the desired size with regular scissors and write on it. The cut length is 1 metre.</p>
<p>MT-150 Coloured magnetic tape 150 mm for labelling and cutting rolls of 1 m Weight: 560 g/m</p>	<p>Price in EUR</p> <p>1 m 10,33/m</p> <p>from 3 m 8,93/m</p> <p>from 10 m 7,68/m</p> <p>from 20 m 7,08/m</p> <p>from 40 m 6,54/m</p>	<p>The magnetic band MT-150 is 150 mm wide and available in many different colours. You can cut it to the desired size with regular scissors and write on it. The cut length is 1 metre.</p>

Magnetic adhesive tape for flexible attachments

Self-adhesive magnetic tape can be used to inconspicuously attach non-magnetic objects (e.g. a plastic or aluminium sign) to metal surfaces. The self-adhesive strips also adhere to each other, so you can combine two non-magnetic objects. It's perfect for attaching flexible fly screens to windows and doors.

<p>MT-10-STIC Magnetic adhesive tape ferrite 10 mm self-adhesive magnetic tape rolls of 1 m / 5 m / 25 m Weight: 56 g/m</p>	<p>Price in EUR</p> <p>1 m 2,11/m from 5 m 1,65/m from 25 m 1,29/m from 50 m 1,17/m from 75 m 1,11/m</p>	<p>The self-adhesive magnetic tape MT-10-STIC can attach non-magnetic objects to metal surfaces. This magnetic tape is 10 mm wide and available in lengths of 1 m, 5 m and 25 m.</p>
<p>MT-20-STIC Magnetic adhesive tape ferrite 20 mm self-adhesive magnetic tape rolls of 1 m / 5 m / 25 m Weight: 110 g/m</p>	<p>Price in EUR</p> <p>1 m 2,64/m from 5 m 2,10/m from 25 m 1,69/m from 50 m 1,55/m from 75 m 1,47/m</p>	<p>The self-adhesive magnetic tape MT-20-STIC can attach non-magnetic objects to metal surfaces. This magnetic tape is 20 mm wide and available in lengths of 1 m, 5 m and 25 m.</p>
<p>MT-30-STIC Magnetic adhesive tape ferrite 30 mm self-adhesive magnetic tape rolls of 1 m / 5 m / 25 m Weight: 170 g/m</p>	<p>Price in EUR</p> <p>1 m 2,87/m from 5 m 2,30/m from 25 m 1,87/m from 50 m 1,72/m from 75 m 1,64/m</p>	<p>The self-adhesive magnetic tape MT-30-STIC can attach non-magnetic objects to metal surfaces. This magnetic tape is 30 mm wide and available in lengths of 1 m, 5 m and 25 m.</p>
<p>MT-40-STIC Magnetic adhesive tape ferrite 40 mm self-adhesive magnetic tape rolls of 1 m / 5 m / 25 m Weight: 220 g/m</p>	<p>Price in EUR</p> <p>1 m 3,66/m from 5 m 2,96/m from 25 m 2,43/m from 50 m 2,25/m from 75 m 2,15/m</p>	<p>The self-adhesive magnetic tape MT-40-STIC can attach non-magnetic objects to metal surfaces. This magnetic tape is 40 mm wide and available in lengths of 1 m, 5 m and 25 m.</p>
<p>MT-150-STIC Magnetic adhesive tape ferrite 150 mm self-adhesive magnetic tape rolls of 1 m / 5 m / 25 m Weight: 830 g/m</p>	<p>Price in EUR</p> <p>1 m 10,08/m from 5 m 8,43/m from 25 m 7,19/m from 50 m 6,76/m from 75 m 6,53/m</p>	<p>The self-adhesive magnetic tape MT-150-STIC helps to attach non-magnetic objects on metal surfaces. This magnetic tape is 150 mm wide and available in lengths of 1 m, 5 m and 25 m.</p>
<p>MT-DISP Magnetic adhesive tape for photos 5 m in dispenser Weight: 150 g</p>	<p>Price in EUR</p> <p>1 pc. 5,25 ea. from 3 pcs. 4,52 ea. from 10 pcs. 3,85 ea. from 20 pcs. 3,53 ea. from 40 pcs. 3,25 ea.</p>	<p>The tape that is both adhesive and magnetic. It attaches photos, postcards and other lightweight things easily and quickly to ferromagnetic surfaces, without making holes.</p>
<p>NMT-10-STIC Magnetic adhesive tape neodymium 10 mm self-adhesive magnetic tape extra-strong adhesive force rolls of 1 m Weight: 75 g/m</p>	<p>Price in EUR</p> <p>1 m 16,64/m from 3 m 14,77/m from 10 m 13,10/m from 20 m 12,29/m from 40 m 11,57/m</p>	<p>This self-adhesive magnetic tape (10 mm wide) features a phenomenal adhesive force of 450 g/cm² and is therefore 4x stronger than a regular magnetic tape.</p>
<p>NMT-20-STIC Magnetic adhesive tape neodymium 20 mm self-adhesive magnetic tape extra-strong adhesive force rolls of 1 m Weight: 150 g/m</p>	<p>Price in EUR</p> <p>1 m 30,39/m from 3 m 27,18/m from 10 m 24,31/m from 20 m 22,91/m from 40 m 21,68/m</p>	<p>This self-adhesive magnetic tape (20 mm wide) features a phenomenal adhesive force of 450 g/cm² and is therefore 4x stronger than a regular magnetic tape.</p>

NMT-30-STIC

Magnetic adhesive tape
neodymium 30 mm
self-adhesive magnetic tape
extra-strong adhesive force
rolls of 1 m
Weight: 230 g/m

Price in EUR

	1 m	41,54/m
from	3 m	37,28/m
from	10 m	33,47/m
from	20 m	31,62/m
from	40 m	29,98/m

This self-adhesive magnetic tape (30 mm wide) features a phenomenal adhesive force of 450 g/cm² and is therefore 4x stronger than a regular magnetic tape.

Magnetic sheet for arts & crafts, highlighting and labelling

You can cut out colourful shapes from our magnetic sheets and attach them to whiteboards, for instance, as part of a presentation. Or you can use already punched-out coloured magnetic symbols. With our magnetic pocket you can protect and attach colour-coded statistics and process directives on iron surfaces.

<p>MS-W Prohibition signs magnetic various prohibition signs Weight: 65 g</p>	<p>Price in EUR 1 pc. 3,90 ea. from 3 pcs. 3,38 ea. from 10 pcs. 2,92 ea. from 20 pcs. 2,69 ea. from 40 pcs. 2,49 ea.</p>	<p>The big advantage of magnetic prohibition signs: They can be attached quickly to smooth ferromagnetic surfaces. Thanks to the flexible magnetic foil they can also be removed easily and without leaving a residue.</p>
<p>QMS-A4-STIC Magnetic frame self-adhesive A4 to display notes A4 format Weight: 130 g</p>	<p>Price in EUR 1 pc. 5,33 ea. from 3 pcs. 4,66 ea. from 10 pcs. 4,07 ea. from 20 pcs. 3,78 ea. from 40 pcs. 3,53 ea.</p>	<p>Self-adhesive magnetic frames in A4 format can be used on smooth, non-magnetic surfaces. Use them to quickly put up and change notices as needed.</p>
<p>QMS-A5-STIC Magnetic frame self-adhesive A5 to display notes A5 format Weight: 92 g</p>	<p>Price in EUR 1 pc. 4,27 ea. from 3 pcs. 3,69 ea. from 10 pcs. 3,18 ea. from 20 pcs. 2,92 ea. from 40 pcs. 2,70 ea.</p>	<p>The self-adhesive magnetic frames in A5 format can be used on smooth, non-magnetic surfaces. Use them to quickly put up and change notices as needed.</p>
<p>MS-100500MWBM Whiteboard sheet magnetic magnetic backside 1 x 5 m roll not a magnetic base for magnets Weight: 8 kg</p>	<p>Price in EUR 1 pc. 149,90 ea.</p>	<p>With this magnetic whiteboard sheet you can turn an iron surface into a whiteboard in no time. Just cut the sheet to the desired size and attach it to an iron surface.</p>
<p>MS-A4 Coloured magnetic sheet for labelling and arts & crafts A4 format Weight: 230 g</p>	<p>Price in EUR 1 pc. 3,90 ea. from 3 pcs. 3,38 ea. from 10 pcs. 2,92 ea. from 20 pcs. 2,69 ea. from 40 pcs. 2,50 ea.</p>	<p>For labelling, arts & crafts, marking - the only limit is your imagination. The A4 magnetic sheets are available in 13 different colours. The sheet is 1 mm thick and you can cut it and write on it.</p>
<p>MS-A4-STIC Self-adhesive magnetic sheet A4 format to cut & glue grey-black Weight: 230 g</p>	<p>Price in EUR 1 pc. 4,00 ea. from 3 pcs. 3,47 ea. from 10 pcs. 3,00 ea. from 20 pcs. 2,77 ea. from 40 pcs. 2,56 ea.</p>	<p>The A4 magnetic sheet with self-adhesive side can be cut to the desired size and lends itself to hanging up larger objects that require an increased adhesive force.</p>
<p>NMS-A4-STIC Self-adhesive magnetic sheet neodymium with extra-strong adhesive force A4 format Weight: 470 g</p>	<p>Price in EUR 1 pc. 73,95 ea. from 3 pcs. 66,77 ea. from 10 pcs. 60,36 ea. from 20 pcs. 57,24 ea.</p>	<p>Self-adhesive magnetic sheet made of neodymium with an adhesive force of 450 g/cm²</p>
<p>MIP-A4-01 Magnetic paper glossy perfect for photo magnets printable on inkjet printers set of 10 A4 sheets Weight: 500 g/set</p>	<p>Price in EUR 1 set 12,99/set</p>	<p>With this magnetic paper (glossy) you can turn your photos into individual fridge magnets in no time. Print photo on this paper, cut it to the desired size, attach it to a metal surface - done!</p>

<p>MIP-A4-02 Magnetic paper matt perfect for photo magnets printable on inkjet printers set of 10 A4 sheets Weight: 420 g/set</p>	<p>Price in EUR 1 set 12,99/set</p>	<p>With this magnetic paper (matt) you can turn your photos into individual fridge magnets in no time. Print photo on this paper, cut it to the desired size, attach it to a metal surface - done!</p>
<p>QMS-A4 Magnetic frame A4 to display notes for whiteboards, cupboards, etc. Weight: 100 g</p>	<p>Price in EUR 1 pc. 4,02 ea. from 3 pcs. 3,49 ea. from 10 pcs. 3,02 ea. from 20 pcs. 2,80 ea. from 40 pcs. 2,59 ea.</p>	<p>With the magnetic frames you can display and protect work schedules, statistics or notes in A4 format on whiteboards or other ferromagnetic surfaces.</p>
<p>QMS-A5 Magnetic frame A5 to display notes for whiteboards, cupboards, etc. Weight: 69 g</p>	<p>Price in EUR 1 pc. 3,54 ea. from 3 pcs. 3,07 ea. from 10 pcs. 2,64 ea. from 20 pcs. 2,44 ea. from 40 pcs. 2,25 ea.</p>	<p>With the magnetic frames you can display and protect work schedules, statistics or notes in A5 format on whiteboards or other ferromagnetic surfaces.</p>

Takkis: Self-adhesive magnetic dots for a wide range of applications

<p>MS-TAKKI-03 Takkis 10 x 10 mm self-adhesive magnetic squares 160 pieces per sheet Weight: 60 g</p>	<p>Price in EUR 1 pc. 3,60 ea. from 3 pcs. 3,03 ea. from 10 pcs. 2,51 ea. from 20 pcs. 2,26 ea. from 40 pcs. 2,04 ea.</p>	<p>Takkis are small magnetic squares with a self-adhesive backing. You can use them to attach photos, cards, drawings, etc. to iron surfaces. If you order one piece, you will receive one sheet with 160 magnetic squares sized 10 x 10 mm.</p>
<p>MS-TAKKI-01 Takkis 20 x 20 mm self-adhesive magnetic squares 40 pieces per sheet Weight: 60 g</p>	<p>Price in EUR 1 pc. 3,60 ea. from 3 pcs. 3,03 ea. from 10 pcs. 2,51 ea. from 20 pcs. 2,26 ea. from 40 pcs. 2,04 ea.</p>	<p>Takkis are small magnetic squares with a self-adhesive backing. You can use them to attach photos, cards, drawings, etc. to iron surfaces. If you order one piece, you will receive one sheet with 40 magnetic squares sized 20 x 20 mm.</p>
<p>MS-TAKKI-02 Takkis 30 x 30 mm self-adhesive magnetic squares 20 pieces per sheet Weight: 70 g</p>	<p>Price in EUR 1 pc. 3,60 ea. from 3 pcs. 3,03 ea. from 10 pcs. 2,51 ea. from 20 pcs. 2,26 ea. from 40 pcs. 2,04 ea.</p>	<p>These small magnetic squares come with a self-adhesive backside. You can use them to attach photos, cards, drawings, etc. to iron surfaces. If you order 1, you will receive 1 sheet with 20 magnetic squares size 30 x 30 mm.</p>
<p>MS-TAKKI-04 Takkis round 10 mm self-adhesive magnetic dots 60 pieces per sheet Weight: 60 g</p>	<p>Price in EUR 1 pc. 3,60 ea. from 3 pcs. 3,03 ea. from 10 pcs. 2,51 ea. from 20 pcs. 2,26 ea. from 40 pcs. 2,04 ea.</p>	<p>Takkis are small round magnetic dots with a self-adhesive backing. You can use them to attach photos, cards, drawings, etc. to iron surfaces. If you order one piece, you will receive one sheet containing 60 magnetic dots with a diameter of 10 mm.</p>
<p>MS-TAKKI-05 Takkis round 20 mm self-adhesive magnetic dots 24 pieces per sheet Weight: 60 g</p>	<p>Price in EUR 1 pc. 3,60 ea. from 3 pcs. 3,03 ea. from 10 pcs. 2,51 ea. from 20 pcs. 2,26 ea. from 40 pcs. 2,04 ea.</p>	<p>Takkis are small round magnetic dots with a self-adhesive backing. You can use them to attach photos, cards, drawings, etc. to iron surfaces. If you order one piece, you will receive one sheet containing 24 magnetic dots with a diameter of 20 mm.</p>

Magnetic labels / magnetic signs for flexible labelling of shelves and closets

You can use magnetic c-profiles to label iron cupboards, storage shelves, drawers, etc. in a professional and flexible way. These practical magnetic labels will be delivered with a blank paper insert and a protective PVC foil.

<p>MIP-A4-03 Magnetic labels printable A4 sheets with perforated labels printable on inkjet printers for labelling metal shelves, whiteboards, etc. Weight: 470 g</p>	<p>Price in EUR 1 pc. 29,90 ea.</p>	<p>Printable magnetic labels by Avery. The labels can be printed on inkjet printers and are easily separated afterwards, thanks to the perforation.</p>
<p>CP-40100 Magnetic labels 100 x 40 mm magnetic C-profiles printable on inkjet and laser printers for labelling metal shelves Weight: 21 g</p>	<p>Price in EUR 10 pcs. 0,65 ea. from 40 pcs. 0,53 ea. from 80 pcs. 0,49 ea. from 160 pcs. 0,44 ea.</p>	<p>With these 100 x 40 mm magnetic labels you can label iron cupboards, shelves, drawers, etc. in a clean and flexible way.</p>
<p>CP-3080 Magnetic labels 80 x 30 mm magnetic C-profiles printable on inkjet and laser printers for labelling metal shelves Weight: 12 g</p>	<p>Price in EUR 10 pcs. 0,48 ea. from 40 pcs. 0,39 ea. from 80 pcs. 0,35 ea. from 160 pcs. 0,32 ea.</p>	<p>With these 80 x 30 mm magnetic labels you can label iron cupboards, shelves, drawers, etc. in a clean and flexible way.</p>
<p>CP-2060 Magnetic labels 60 x 20 mm magnetic C-profiles printable on inkjet and laser printers for labelling metal shelves Weight: 6 g</p>	<p>Price in EUR 10 pcs. 0,37 ea. from 40 pcs. 0,30 ea. from 80 pcs. 0,27 ea. from 160 pcs. 0,25 ea.</p>	<p>With these 60 x 20 mm magnetic labels you can label iron cupboards, shelves, drawers, etc. in a clean and flexible way.</p>
<p>CP-1040 Magnetic labels 40 x 10 mm magnetic C-profiles printable on inkjet and laser printers for labelling metal shelves Weight: 2 g</p>	<p>Price in EUR 10 pcs. 0,26 ea. from 40 pcs. 0,21 ea. from 80 pcs. 0,19 ea. from 160 pcs. 0,17 ea.</p>	<p>With these 40 x 10 mm magnetic labels you can label iron cupboards, shelves, drawers, etc. in a clean and flexible way.</p>
<p>BA-015LN Letters & numbers magnetic for labelling metal shelves 2-piece set 120 characters per A4 sheet Weight: 510 g/set</p>	<p>Price in EUR 1 set 14,99/set from 3 sets 12,82/set from 10 sets 10,87/set from 20 sets 9,93/set</p>	<p>Sets with punch-out magnetic letters or numbers (two A4 sheets each). The black characters on white background work well on whiteboards, magnetic boards or for labeling metal shelves.</p>
<p>BA-022 Days of the week magnets for organisation and planning 2-piece set 56 magnets per A5 sheet Weight: 240 g/set</p>	<p>Price in EUR 1 set 4,99/set from 3 sets 4,34/set from 10 sets 3,75/set from 20 sets 3,46/set from 40 sets 3,21/set</p>	<p>One set includes two A5 sheets, each containing 56 days of the week magnets. Each sheet has 28 magnets with the days written out and 28 with abbreviated days. Perfect for planning boards.</p>
<p>BA-023 Month magnets for organisation and planning 2-piece set 60 magnets per A5 sheet Weight: 240 g/set</p>	<p>Price in EUR 1 set 4,99/set from 3 sets 4,34/set from 10 sets 3,75/set from 20 sets 3,46/set from 40 sets 3,21/set</p>	<p>One set includes two A5 sheets with 60 month magnets each. Each sheet has 30 magnets with the months written out and 30 with abbreviated months. Perfect for planning boards.</p>

CP-INLAY

Label replacement paper
blank insert for magnetic
labels
10 sheets per package
Weight: 75 g/set

Price in EUR

	1 set	8,05/set
from	3 sets	7,06/set
from	10 sets	6,17/set
from	20 sets	5,74/set
from	40 sets	5,35/set

These perforated A4 sheets contain inserts that fit exactly into our magnetic label holders. The sheets can be used in standard printers.

Office and pinboard magnets: strong hold on whiteboard and magnetic board

These strong neodymium office magnets are perfectly suitable for whiteboards, magnetic walls and school blackboards. They are multiple times stronger than standard ferrite office magnets.

On magnetic glass boards, however, only certain types of office magnets can be used, depending on the thickness of the glass.

<p>M-95 Disc magnets with silicone coating adhesive on both sides set of 10, Ø 18 mm assorted colours Weight: 76 g/set strength: approx. 800 g</p>	<p>Price in EUR 1 set 23,68/set</p>	<p>10 in a set, colour-assorted (2 each in blue, yellow, grey, green, orange). Good grip, coated with silicone.</p>
<p>M-98 Sphere magnets with silicone coating set of 4 Ø 12 mm Weight: 45 g/set strength: approx. 600 g</p>	<p>Price in EUR 1 set 11,25/set</p>	<p>These blue sphere magnets are coated with silicone, making them especially easy to grip. They are great for use on whiteboards, magnetic boards and glass memo boards.</p>
<p>M-OF-S08 Knob magnets with metal casing office magnets neodymium with grooved handle Weight: 6 g strength: approx. 1,5 kg</p>	<p>Price in EUR 10 pcs. 2,27 ea.</p>	<p>Neodymium knob magnets with metal casing. The grooves on the grip ensure that you can easily remove these magnets from magnetic surfaces.</p>
<p>M-OF-W08 Office magnets with metal casing neodymium magnets edge length 8 mm Weight: 4 g strength: approx. 1,5 kg</p>	<p>Price in EUR 10 pcs. 2,14 ea.</p>	<p>This nickel-coated metal casing contains a small but strong neodymium magnet.</p>
<p>M-PC Blackboard magnets cylindrical neodymium magnets with plastic cap Ø 14 mm in different colours Weight: 7,7 g strength: approx. 3,9 kg</p>	<p>Price in EUR 5 pcs. 1,99 ea. from 15 pcs. 1,79 ea. from 40 pcs. 1,64 ea. from 80 pcs. 1,54 ea.</p>	<p>Ideal for magnetic glass boards, whiteboards, magnetic boards, or walls painted with magnetic paint - strong even on smooth surfaces.</p>
<p>M-OF-RD30 Board magnets made of ferrite set of 10 office magnets Ø 30 mm in different colours Weight: 14 g/set</p>	<p>Price in EUR 1 set 4,99/set</p>	<p>Classical ferrite board magnet that can be easily grasped thanks to its plastic cap. Available in different colours.</p>
<p>M-OF-P17 Knob magnets with eyelet strong office magnets neodymium plasticised in different colours Weight: 7 g strength: approx. 3 kg</p>	<p>Price in EUR 10 pcs. 1,45 ea.</p>	<p>This plastic-covered magnet is very handy thanks to its broad knob.</p>
<p>M-PIN Magnetic pins "Player" bulletin board magnets in the shape of a pawn in a game, Ø 12,5 mm set of 10 in different colours Weight: 28 g/set strength: approx. 1,6 kg</p>	<p>Price in EUR 1 set 13,80/set from 3 sets 11,92/set from 10 sets 10,24/set from 20 sets 9,42/set</p>	<p>Very strong magnetic pin with practical knob. Holds ten A4 sheets of paper with no problem. In various colours. Set of 10 pins.</p>

<p>M-81 Flag magnets for presenting and organising assorted set of 6 Weight: 8,5 g/set</p>	<p>Price in EUR 1 set 9,99/set</p>	<p>Flag magnets that can also be used on pin boards thanks to the removable flag needle.</p>
<p>BX-RD20 Office magnets 'Boston Xtra Mini' round noticeboard magnets neodymium Ø 20 mm, set of 10 in different colours Weight: 49 g/set strength: approx. 1,5 kg</p>	<p>Price in EUR 1 set 11,23/set from 3 sets 9,85/set from 10 sets 8,63/set from 20 sets 8,03/set from 40 sets 7,50/set</p>	<p>A small, discreet plastic magnet, which - despite its small size - is stronger than many large magnets.</p>
<p>M-OF-BRD25 Blackboard magnets round neodymium magnets with plastic cap adhesive on both sides, Ø 25 mm in different colours Weight: 12 g strength: approx. 1,5 kg</p>	<p>Price in EUR 5 pcs. 1,39 ea.</p>	<p>The transparent neodymium blackboard magnets are especially suitable for glass memo boards. They also look good on whiteboards and magnetic boards. They can be attached on either side!</p>
<p>BX-RD30 Office magnets 'Boston Xtra' round noticeboard magnets neodymium Ø 32,6 mm, set of 5 in different colours Weight: 54 g/set strength: approx. 1,5 kg</p>	<p>Price in EUR 1 set 8,66/set from 3 sets 7,53/set from 10 sets 6,51/set from 20 sets 6,02/set from 40 sets 5,58/set</p>	<p>An office magnet that is strong and pretty! The whiteboard magnet Boston Xtra round contains a super magnet and is therefore two to three times as strong as a standard ferrite office magnet.</p>
<p>BX-RD30-BULK Office magnets 'Boston Xtra' round 25 pieces noticeboard magnets neodymium Ø 32,6 mm, set of 25 in different colours Weight: 160 g/set strength: approx. 1,5 kg</p>	<p>Price in EUR 1 set 34,42/set from 3 sets 30,30/set from 10 sets 26,62/set</p>	<p>BX-RD30 in a box of 25.</p>
<p>BX-TR30 Office magnets 'Boston Xtra' triangular noticeboard magnets neodymium set of 5 in different colours Weight: 54 g/set strength: approx. 1,5 kg</p>	<p>Price in EUR 1 set 8,66/set from 3 sets 7,53/set from 10 sets 6,51/set from 20 sets 6,02/set from 40 sets 5,58/set</p>	<p>An office magnet that is strong and pretty! The whiteboard magnet Boston Xtra triangular contains a super magnet and is therefore two to three times as strong as a standard ferrite office magnet.</p>
<p>BX-TR30-BULK Office magnets 'Boston Xtra' triangular 25 pieces noticeboard magnets neodymium set of 25 in different colours Weight: 160 g/set strength: approx. 1,5 kg</p>	<p>Price in EUR 1 set 34,42/set from 3 sets 30,30/set from 10 sets 26,62/set</p>	<p>BX-TR30 in a box of 25.</p>
<p>BX-SQ30 Office magnets 'Boston Xtra' square noticeboard magnets neodymium set of 5 in different colours Weight: 54 g/set strength: approx. 1,5 kg</p>	<p>Price in EUR 1 set 8,66/set from 3 sets 7,53/set from 10 sets 6,51/set from 20 sets 6,02/set from 40 sets 5,58/set</p>	<p>An office magnet that is strong and pretty! The whiteboard magnet Boston Xtra square contains a super magnet and is therefore two to three times as strong as a standard ferrite office magnet.</p>
<p>BX-SQ30-BULK Office magnets 'Boston Xtra' square 25 pieces noticeboard magnets neodymium set of 25 in different colours Weight: 170 g/set strength: approx. 1,5 kg</p>	<p>Price in EUR 1 set 34,42/set from 3 sets 30,30/set from 10 sets 26,62/set</p>	<p>BX-SQ30 in a box of 25.</p>

<p>PBM-12 Office magnets 'Steel 12' neodymium magnets in steel pot Ø 12 mm Weight: 5 g strength: approx. 1,5 kg</p>	<p>Price in EUR 5 pcs. 1,26 ea. from 15 pcs. 1,09 ea. from 40 pcs. 0,97 ea. from 80 pcs. 0,90 ea.</p>	<p>The smallest of the steel office magnets. A fine piece at a low cost.</p>
<p>PBM-22 Office magnets 'Steel 22' neodymium magnets in steel pot Ø 22 mm Weight: 20 g strength: approx. 4 kg</p>	<p>Price in EUR 5 pcs. 1,82 ea. from 15 pcs. 1,59 ea. from 40 pcs. 1,42 ea. from 80 pcs. 1,32 ea.</p>	<p>Exceptionally strong and beautiful steel office magnet. The surface is nickel-plated and brushed.</p>
<p>PBM-25 Office magnets 'Steel 25' neodymium magnets in steel pot Ø 25 mm Weight: 27 g strength: approx. 8 kg</p>	<p>Price in EUR 5 pcs. 2,05 ea. from 15 pcs. 1,80 ea. from 40 pcs. 1,61 ea. from 80 pcs. 1,50 ea.</p>	<p>The bigger and older brother of the Steel 22. With its adhesive force of 8 kg, it is certainly not easily removed from a piece of metal.</p>
<p>PBM-30 Office magnets 'Steel 30' neodymium magnets in steel pot Ø 30 mm Weight: 40 g strength: approx. 12 kg</p>	<p>Price in EUR 1 pc. 3,44 ea. from 3 pcs. 2,99 ea. from 10 pcs. 2,59 ea. from 20 pcs. 2,40 ea. from 40 pcs. 2,23 ea.</p>	<p>This XXL edition with over 10 kg adhesive force is ideal for finger strength training. It's also optimal for metal plates and similar.</p>
<p>M-52 Magnetic pins 'Mini Max' silver-coloured strong office magnets neodymium set of 4 Weight: 45 g/set strength: approx. 3,9 kg</p>	<p>Price in EUR 1 set 13,97/set</p>	<p>These silver magnets with a knob have an impressive adhesive force, are easy to grasp and look classy. Perfect for the office or as a practical and pretty gift.</p>
<p>M-92 Magnetic pins 'Mini Max' gold-coloured strong office magnets neodymium set of 4 Weight: 45 g/set strength: approx. 3,9 kg</p>	<p>Price in EUR 1 set 13,97/set</p>	<p>The golden magnets with a knob win you over with their impressive holding power, easy grip, and classy design. Perfect for the office or as a practical and beautiful gift.</p>
<p>M-99 Magnetic pins 'Mini-Max' silver-blue strong office magnets neodymium set of 4 Weight: 45 g/set strength: approx. 3,9 kg</p>	<p>Price in EUR 1 set 13,97/set</p>	<p>The popular Mini-Max office magnets are now available in a crisp silver-blue colour choice. They sit comfortably in your hand, thanks to the knob, and also have an impressive adhesive force.</p>
<p>M-51 Magnetic pins 'The Boss' strong office magnets neodymium set of 3 Weight: 140 g/set strength: approx. 7 kg</p>	<p>Price in EUR 1 set 16,07/set</p>	<p>These magnetic pins have an impressive 7 kg adhesive force, are easy to grasp and look very sophisticated. Perfect for the office or as a practical and pretty gift.</p>
<p>M-97 Magnetic keychain strong neodymium magnets with keyring set of 3 Weight: 53 g/set strength: approx. 200 g</p>	<p>Price in EUR 1 set 11,99/set</p>	<p>A strong magnet is built into each keychain, so going forward, your keys will stick to almost any metallic surface. Perfect when combined with magnetic boards or magnetic strips.</p>

<p>M-20 Boss Magnet small exclusive office magnet neodymium made of aluminium Weight: 10 g strength: approx. 3,9 kg</p>	<p>Price in EUR</p> <p>1 pc. 7,89 ea.</p> <p>from 3 pcs. 7,16 ea.</p> <p>from 10 pcs. 6,50 ea.</p> <p>from 20 pcs. 6,19 ea.</p> <p>from 40 pcs. 5,90 ea.</p>	<p>The grip is made out of a piece of aluminium and a 12 x 6 mm magnetic disc has been inserted. This exclusive magnet is produced especially for us in a small workshop in Switzerland and is of the finest Swiss quality.</p>
<p>M-21 Boss magnet large exclusive office magnet neodymium made of aluminium Weight: 47 g strength: approx. 12 kg</p>	<p>Price in EUR</p> <p>1 pc. 13,87 ea.</p> <p>from 3 pcs. 12,65 ea.</p> <p>from 10 pcs. 11,57 ea.</p> <p>from 20 pcs. 11,05 ea.</p> <p>from 40 pcs. 10,58 ea.</p>	<p>The Mercedes Maybach of office magnets! 12 kg adhesive force - enough to affix 50 sheets of A4 paper to the wall!</p>
<p>M-DOTS Magnet pins round 10 per set Ø 13 mm 10 different colours Weight: 50 g/set strength: approx. 2,7 kg</p>	<p>Price in EUR</p> <p>1 set 9,99/set</p>	<p>Assorted in ten bright colours, these pin board magnets with embedded neodymium magnet are perfect for office, workshop or home.</p>
<p>SALE-110 Office icons square various designs set of 6 Weight: 39 g/set</p>	<p>Price in EUR</p> <p>1 set 3,90/set</p>	<p>Transparent magnets with colourful symbols for daily use on the whiteboard in the office. A set includes six symbols: phone, letter, lightbulb, exclamation mark, alarm clock and checkmark.</p>

Office accessories: practical helpers for office and desk

Here you can find decorative articles that will pimp your office routine and your desk: Elegant and original paper clip holders, paperweights, pencil holders and letter openers. Some of the articles are not magnetic, which is mentioned in the product description.

<p>M-MLY-13 Binder clips "mauly" 13 mm metal set of 12 not magnets! Weight: 110 g/set</p>	<p>Price in EUR 1 set 1,65/set</p>	<p>Binder clips made of rust-resistant spring steel, allowing you to clip together 130 sheets of paper weighing 80 g/ m². One set contains 12 clips.</p>
<p>M-MLY-19 Binder clips "mauly" 19 mm metal set of 12 not magnets! Weight: 180 g/set</p>	<p>Price in EUR 1 set 2,65/set</p>	<p>Large binder clips made of rust-resistant spring steel, allowing you to clip together 190 sheets of paper weighing 80 g/ m². One set contains 12 clips.</p>
<p>M-85 Letter clamp 95 mm made of metal, black set of 2 not magnets! Weight: 80 g/set</p>	<p>Price in EUR 1 set 10,66/set</p>	<p>Practical file clamps with many positive features: practically indestructible, powerful, warp resistant, universal use. Ideal for storing, reminding, bundling, pressing or gluing of letters, documents, files, and notes.</p>
<p>M-87 Letter clamp 50 mm made of metal, silver-coloured set of 10 not magnets! Weight: 80 g/set</p>	<p>Price in EUR 1 set 6,20/set</p>	<p>Practical file clamps with many positive features: Sturdy, strong, universal use. Ideal for storing, reminding, bundling, pressing or gluing letters, documents, files, and notes.</p>
<p>M-CLIP Paper clip dispenser magnetic with strong magnet in the centre plastic in different colours Weight: 90 g</p>	<p>Price in EUR 1 pc. 8,21 ea.</p>	<p>This magnetic paper clip dispenser for the office or the desk at home keeps paperclips handy. It is made of shatter-proof plastic and available in nine different colours.</p>
<p>BA-013 Magnetic clips MAUL self-adhesive set of 10 Weight: 190 g/set</p>	<p>Price in EUR 1 set 26,78/set</p>	<p>Self-adhesive magnetic clips for hanging important information, such as drawings. Just insert material into the clips. They snap shut automatically, so even large maps can be hung by just one person.</p>
<p>M-57 Paper clips colourful 100 pieces per package Weight: 48 g/set</p>	<p>Price in EUR 1 set 1,98/set from 3 sets 1,79/set from 10 sets 1,62/set</p>	<p>Pretty plastic-covered paper clips. Perfect accessories to our magnetic paper clip holders.</p>
<p>M-OFFICE-SETRG Clip Lounge & Opener paperweight letter opener paperclip holder Weight: 550 g</p>	<p>Price in EUR 1 pc. 49,99 ea.</p>	<p>Desk set, containing: 1) Paperweight with magnet for paperclips, 2) Classy letter opener Colour: rose-gold. Recipient of the "German Design Award Special 2016" as Product of the Year!</p>

Fridge magnets - attractive colourful & decorative magnets

Here you can find attractive colourful magnets for decoration or gifts in all imaginable shapes and materials. Most of them are perfectly suitable to use on a refrigerator or photo rope.

LIV-140 Trauffer wooden animals magnetic handmade fridge magnets 4 different animals available Weight: 14 g	Price in EUR 1 pc. 13,42 ea.	We embedded a small but strong super magnet in the back of each wooden animal, turning these Trauffer animals into practical and decorative refrigerator magnets.
LIV-141 Trauffer wooden cows magnetic handmade fridge magnets 2 different cows available Weight: 14 g	Price in EUR 1 pc. 11,35 ea.	The cows made by traditional Swiss brand Trauffer now have superpowers! We embedded a small but strong super magnet in the back of each wooden cow.
LIV-151 Fridge magnets 'Brass' sphere-shaped set of 4, gold-coloured Weight: 52 g/set	Price in EUR 1 set 8,99/set	Thanks to their golden colour, the sphere-shaped decorative "Brass" magnets provide a stylish focal point and modern touch.
SALE-122 Decorative magnets 'ZEN' magnetic stone made of glass set of 4 Weight: 46 g/set	Price in EUR 1 set 4,99/set	The set of 4 includes stone magnets in the pastel colours blue, turquoise, orange and white.
SALE-123 Blowfish magnets fish-shaped fridge magnets set of 5 Weight: 72 g/set	Price in EUR 1 set 4,99/set	The set of 5 includes two blowfish in pink and one each in green, yellow and blue.
SALE-128 Squirrel magnets squirrel-shaped fridge magnets set of 5 Weight: 67 g/set	Price in EUR 1 set 4,99/set	This happy group of squirrels is looking forward to serving on refrigerators and magnetic boards. They will make sure that your notes and photos stay in their assigned spot.
LIV-117 Smiley magnet 'Girl' plasticised, yellow Weight: 9 g	Price in EUR 1 pc. 1,00 ea.	Cute smiley magnet that spreads good mood in every room.
LIV-118 Glass magnets rescue vehicles handmade fridge magnets set of 3 Weight: 18 g/set	Price in EUR 1 set 11,55/set	Pretty glass magnets with rescue vehicles. Handmade in Switzerland.

<p>LIV-119 Glass magnets lucky charm handmade fridge magnets set of 3 Weight: 18 g/set</p>	<p>Price in EUR 1 set 11,55/set</p>	<p>Pretty glass magnets with lucky charms. Handmade in Switzerland.</p>
<p>LIV-120 Glass magnets legendary animals handmade fridge magnets set of 3 Weight: 18 g/set</p>	<p>Price in EUR 1 set 11,55/set</p>	<p>Decorative glass magnets with hand-painted iconic animals - each of them one-of-a-kind</p>
<p>LIV-128 Glass magnets shore animals handmade fridge magnets set of 3 Weight: 18 g/set</p>	<p>Price in EUR 1 set 11,55/set</p>	<p>Decorative glass magnets with hand-painted shore animal designs - each piece is one-of-a-kind.</p>
<p>LIV-129 Glass magnets Halloween handmade fridge magnets set of 3 Weight: 18 g/set</p>	<p>Price in EUR 1 set 11,55/set</p>	<p>Decorative glass magnets with hand-painted Halloween designs - each piece is one-of-a-kind.</p>
<p>LIV-121 Glass magnets cats handmade fridge magnets set of 3 Weight: 18 g/set</p>	<p>Price in EUR 1 set 11,55/set</p>	<p>Decorative glass magnets with hand-painted cat motifs - each piece is one-of-a-kind.</p>
<p>LIV-123 MagNICI magnetic plush toys with sewn-in magnet in each paw Weight: 22 g</p>	<p>Price in EUR 1 pc. 9,90 ea.</p>	<p>Who doesn't like the legendary NICI plush toys? We have some running around in our supermagnete assortment - naturally with magnetic feet!</p>
<p>LIV-124 Smiley magnet 'Boy' plasticised, yellow Weight: 9 g</p>	<p>Price in EUR 1 pc. 1,00 ea.</p>	<p>Cheerful smiley magnet that spreads good mood in every room.</p>
<p>LIV-110 Fridge magnets 'Crazy Brain' in the shape of a brain assorted set of 12 Weight: 60 g/set strength: approx. 1,8 kg</p>	<p>Price in EUR 1 set 12,00/set</p>	<p>Plastic brains with press-fitted strong neodymium magnet in assorted set of 12.</p>
<p>LIV-111 Building block magnets 'Classic' with press-fitted magnets assorted set of 14 Weight: 27 g/set</p>	<p>Price in EUR 1 set 11,00/set</p>	<p>Coloured bricks in seven bright colours with pressed-in neodymium magnets.</p>

<p>LIV-116 Building block magnets 'Candy' with press-fitted magnets assorted set of 12 Weight: 24 g/set</p>	<p>Price in EUR 1 set 9,99/set</p>	<p>Colourful blocks in six bright colours with strong neodymium magnets on the backside.</p>
<p>SALE-106 Dog magnets made of plastic, velvety set of 5 Weight: 30 g/set</p>	<p>Price in EUR 1 set 4,99/set</p>	<p>Original dog magnets in pastel colours that highlight everything on a magnetic board.</p>
<p>SALE-107 Teddy magnets made of plastic, velvety set of 4 Weight: 30 g/set</p>	<p>Price in EUR 1 set 4,99/set</p>	<p>Original bear magnets in bright colours that are the highlights on any magnetic board.</p>
<p>LIV-95 Magnetic plush toys with sewn-in magnets in each front paw Weight: 20 g</p>	<p>Price in EUR 1 pc. 7,49 ea.</p>	<p>Thanks to the strong magnets inside, the friendly fluffy animals adhere to fridge or magnetic board. You can select from 10 different animal species.</p>
<p>LIV-44 Mini magnets 'Steely' 6 x 3 mm set of 10 in different colours Weight: 24 g/set strength: approx. 800 g</p>	<p>Price in EUR 1 set 9,99/set</p>	<p>Sometimes less is more: Hence, our tiny Steely magnets hold up pictures and documents in a very stylish and discreet fashion. The trendy colours bring pizzazz to your magnetic board, but don't detract from the displayed items.</p>
<p>LIV-83 Felt magnet ladybird hand-crafted decorative magnet made of felt and glass beads in different colours Weight: 9,5 g strength: approx. 600 g</p>	<p>Price in EUR 1 pc. 6,90 ea. from 3 pcs. 6,65 ea.</p>	<p>Luck is radiating in all colours of the rainbow here. The cute-looking bugs are handmade in Switzerland and of high-quality wool felt and sequined. Every lucky one of them is unique!</p>
<p>LIV-51 Duckies magnets duck-shaped fridge magnets set of 6 Weight: 50 g/set strength: approx. 450 g</p>	<p>Price in EUR 1 set 9,99/set</p>	<p>In order to have fun with these very colourful mini rubber duckies, you don't even have to draw a bath. These cute deco magnets shaped as ducks are made for setting colourful accents on your magnetic board.</p>
<p>LIV-114 Piggy magnets pink pig-shaped fridge magnets 3x front side, 3x back side set of 6 Weight: 68 g/set</p>	<p>Price in EUR 1 set 9,99/set</p>	<p>Happy pigs that don't just bring good luck, but also hold notes and postcards on magnetic boards or the fridge.</p>
<p>LIV-52 Sheep magnets fridge magnets shaped as sheep set of 6 Weight: 73 g/set strength: approx. 550 g</p>	<p>Price in EUR 1 set 9,99/set</p>	<p>Shepard wanted! This flock of sheep is looking for someone to take care of them. Who could resist these trusting eyes?</p>

<p>LIV-90 Decorative magnet 'Red Heart' acrylic red heart with zircon incl. organza fabric pouch Weight: 8 g strength: approx. 1,5 kg</p>	<p>Price in EUR 1 pc. 5,49 ea.</p>	<p>Not just for Valentines Day! A red acrylic heart with a little sparkling zircon on the top right. On the backside there is a strong neodymium magnet 12 x 2 mm embedded to hold all those love notes. Each heart is packaged in a silver fabric bag and makes for a great gift.</p>
<p>LIV-80 Decorative magnets 'Sweetheart' heart-shaped set of 6 Weight: 46 g/set strength: approx. 500 g</p>	<p>Price in EUR 1 set 9,99/set</p>	<p>Cute heart-shaped metal magnets.</p>
<p>LIV-66 Penguin magnets penguin-shaped fridge magnets set of 6 Weight: 68 g/set strength: approx. 500 g</p>	<p>Price in EUR 1 set 9,99/set</p>	<p>These penguin magnets will put the limelight on your notes and postcards on the fridge.</p>
<p>LIV-103 Pug magnets dog-shaped fridge magnets set of 5 Weight: 57 g/set strength: approx. 500 g</p>	<p>Price in EUR 1 set 9,99/set</p>	<p>Cute dogs magnets that dutifully watch over notes, photos, etc. on your magnetic board.</p>
<p>LIV-115 Unicorn magnets unicorn-shaped fridge magnets white-pink set of 5 Weight: 67 g/set</p>	<p>Price in EUR 1 set 9,99/set</p>	<p>Awesome fridge magnets with strong neodymium magnets that spread - in typical unicorn manner - endless joy, ease, freedom and love.</p>
<p>LIV-130 Flamingo magnets flamingo-shaped fridge magnets set of 5 Weight: 64 g/set</p>	<p>Price in EUR 1 set 9,99/set</p>	<p>You love flamingos or everything in pink? We have the right magnets for you. We have the trendy water birds as magnets.</p>
<p>LIV-131 Cactus magnets cactus-shaped fridge magnets set of 5 Weight: 66 g/set</p>	<p>Price in EUR 1 set 9,99/set</p>	<p>These cactus magnets are an original way to bring the trendy plants into your home. The best about the magnets: They are fun for plant lovers and people without a green thumb as well.</p>
<p>LIV-132 Piggy magnets gold-coloured pig-shaped fridge magnets set of 5 Weight: 42 g/set</p>	<p>Price in EUR 1 set 9,99/set</p>	<p>These gold-coloured piggy magnets are fabulous on all magnetic surfaces and hold notes and cards in place.</p>
<p>LIV-134 Llama magnets llama-shaped fridge magnets set of 5 Weight: 48 g/set</p>	<p>Price in EUR 1 set 9,99/set</p>	<p>These cute lama magnets with their colourful little saddles will make you smile and beautify every fridge door.</p>

<p>LIV-135 Hedgehog magnets hedgehog-shaped fridge magnets set of 6 Weight: 68 g/set</p>	<p>Price in EUR 1 set 9,99/set</p>	<p>Little magnetic hedgehog family in a set of 6. They like to hang out around notes and postcards.</p>
<p>LIV-136 Mini Christmas ball ornaments fridge magnets round set of 4 Weight: 55 g/set</p>	<p>Price in EUR 1 set 6,99/set</p>	<p>Who says that Christmas ball ornaments only look good on a Christmas tree? Our magnetic mini ornaments in red and green look great on all magnetic surfaces and spread the Christmas spirit.</p>
<p>LIV-138 Black cat magnets cat-shaped fridge magnets set of 5 Weight: 41 g/set</p>	<p>Price in EUR 1 set 9,99/set</p>	<p>The playful black cats are looking for a new home. They are low-maintenance, don't shed, and watch over your notes and pictures.</p>
<p>LIV-139 Glass magnets Kittens decorative magnets with cat designs set of 4 Weight: 120 g/set</p>	<p>Price in EUR 1 set 9,99/set</p>	<p>The baby cats magnets in black-white melt any cat lover's heart. You can't resist these tiny fluffy paws and the cute little ears.</p>
<p>LIV-142 Panda magnets panda-shaped fridge magnets set of 5 Weight: 63 g/set</p>	<p>Price in EUR 1 set 9,99/set</p>	<p>The magnetic pandas love to nestle on metallic surfaces and keep watch over photos, notes and postcards. These adorable bears come in a set of 5.</p>
<p>LIV-143 Fridge magnets 'Donkey' donkey-shaped set of 5 Weight: 65 g/set</p>	<p>Price in EUR 1 set 9,99/set</p>	<p>These adorable grey magnetic donkeys are made of synthetic resin and are anything but stubborn. They enjoy helping you keep your notes and photos on the refrigerator or on magnetic strips.</p>
<p>LIV-144 Paw magnets paw-shaped fridge magnets set of 5 Weight: 67 g/set</p>	<p>Price in EUR 1 set 9,99/set</p>	<p>The colourful paws look great on the refrigerator, on magnetic boards or strips.</p>
<p>LIV-145 Fridge magnets 'Chicken' chicken-shaped set of 6 Weight: 59 g/set</p>	<p>Price in EUR 1 set 9,99/set</p>	<p>Aren't mama hen and her 5 chicks adorable? These feathered friends love to roost on metallic surfaces and keep watch over your postcards, photos and notes.</p>
<p>LIV-146 Decorative magnets 'Jewel' jewel-shaped set of 5 Weight: 64 g/set</p>	<p>Price in EUR 1 set 9,99/set</p>	<p>Quantity per set: 5 pieces Sticks to whiteboard: 4 A4 sheets Brand: Trendform Colour: Transparent Diameter: 19 mm Height: 18 mm</p>

LIV-125 Sloth magnets sloth-shaped fridge magnets white-grey set of 4 Weight: 73 g/set	Price in EUR 1 set 9,99/set	You just have to like these friendly sloths! Get these lazy animals in a set of 4 and let them do what they do best: hang around!
LIV-152 Fridge magnets 'Space' astronaut-shaped white set of 4 Weight: 75 g/set	Price in EUR 1 set 9,99/set	These astronauts are not only drawn by earth's gravity but also magnetically towards metal surfaces.
LIV-153 Fridge magnets 'Barry' in the shape of Saint Bernards white-brown set of 5 Weight: 74 g/set	Price in EUR 1 set 9,99/set	The cute Saint Bernards with their characteristic small barrel around the neck will move into their new home as a set of 5.
LIV-154 Fridge magnets 'Kroko' crocodile-shaped green set of 5 Weight: 69 g/set	Price in EUR 1 set 9,99/set	These little green crocodile magnets will snatch your notes and photos.
LIV-155 Fridge magnets 'Traffic' car-shaped assorted set of 5 Weight: 77 g/set	Price in EUR 1 set 9,99/set	Let's drive! These colourful resin car magnets with a neodymium magnet underneath are rearing to go.
LIV-156 Fridge magnet 'Camper' campervan-shaped assorted set of 5 Weight: 84 g/set	Price in EUR 1 set 9,99/set	You can really showcase your photos and holiday memories with these magnets in the shape of small campervans.
LIV-127 Hippos decorative hippo magnets front and back side magnetic set of 3 Weight: 70 g/set	Price in EUR 1 set 9,99/set	Colourful, friendly hippos that can be used individually to hang up notes and photos on magnetic boards or together as memo holder.
LIV-104 Frog magnets frog-shaped fridge magnet set of 5 Weight: 57 g/set strength: approx. 500 g	Price in EUR 1 set 9,99/set	Four friendly frogs and one frog king are looking forward to hopping on your fridge, whiteboard or magnetic board.
LIV-63 Owl magnets owl-shaped fridge magnets set of 6 Weight: 57 g/set strength: approx. 500 g	Price in EUR 1 set 9,99/set	These magnetic owls keep an eye on your appointment cards on your fridge or magnetic board. Thanks to the strong magnet on the backside, the owls can hold dup to 7 A4 sheets of paper.

<p>LIV-65 Cow magnets cow-shaped fridge magnets set of 6 Weight: 78 g/set strength: approx. 500 g</p>	<p>Price in EUR 1 set 9,99/set</p>	<p>There is no way you can resist the look of these cute cows - two thumbs up!</p>
<p>LIV-91 Decorative magnet 'Diamond Cat' white cat made of plexiglass with Swarovski crystals Weight: 15 g strength: approx. 1,5 kg</p>	<p>Price in EUR 1 pc. 21,95 ea. from 3 pcs. 19,95 ea. from 10 pcs. 18,95 ea.</p>	<p>The white kitty sparkles thanks to white and coloured Swarovski crystals. Through the worldwide unique IMPLEXIONS technique, the precious SWAROVSKI® crystals are embedded seamlessly and without bubbles in high-quality Plexiglas®. The cat measures approx. 42 x 47 mm.</p>
<p>LIV-92 Decorative magnet 'Diamond Dog' black dog made of plexiglass with Swarovski crystals Weight: 11 g strength: approx. 1,5 kg</p>	<p>Price in EUR 1 pc. 21,95 ea. from 3 pcs. 19,95 ea. from 10 pcs. 18,95 ea.</p>	<p>The little black dog with coloured Swarovski crystals has a strong magnet on the back. Through the worldwide unique IMPLEXIONS technique, the precious SWAROVSKI® crystals are embedded seamlessly and without bubbles in high-quality Plexiglas®. The dog measures approx. 47 x 31 mm.</p>
<p>LIV-93 Decorative magnet 'Diamond Rabbit' white rabbit made of plexiglass with Swarovski crystals Weight: 16 g strength: approx. 1,5 kg</p>	<p>Price in EUR 1 pc. 21,95 ea. from 3 pcs. 19,95 ea. from 10 pcs. 18,95 ea.</p>	<p>The white rabbit with the long ears sparkles thanks to white and coloured Swarovski crystals. Through the worldwide unique IMPLEXIONS technique, the precious SWAROVSKI® crystals are embedded seamlessly and without bubbles in high-quality Plexiglas®. The rabbit measures approx. 50 x 27 mm.</p>
<p>SALE-089 Fridge magnets 'Bunny' rabbit-shaped set of 4 Weight: 55 g/set</p>	<p>Price in EUR 1 set 4,95/set</p>	<p>'Kawai' the Japanese would say: Cute! Not just for Easter but the whole year a sweet eye catcher on the fridge.</p>
<p>SALE-090 Fridge magnets 'Honey' bear-shaped set of 4 Weight: 27 g/set</p>	<p>Price in EUR 1 set 4,95/set</p>	<p>So sweet you would want to bite into them! Unfortunately, the honey bears are not made of sugar, but they last longer.</p>
<p>SALE-109 Fridge magnets 'Fancy' in the shape of speech bubbles set of 4 Weight: 53 g/set</p>	<p>Price in EUR 1 set 3,90/set</p>	<p>A magnet says more than a thousand words: Especially with these colourful comic speech bubbles.</p>
<p>LIV-84 Felt magnets "Teddies" hand-crafted decorative magnets made of felt and glass beads set of 2 Weight: 16 g/set strength: approx. 600 g</p>	<p>Price in EUR 1 set 13,95/set from 3 sets 13,15/set</p>	<p>Magnetic bear set: One brown and one polar bear made of felt with embedded magnet. Hand-made in Switzerland - each piece is a one-of-a-kind!</p>
<p>LIV-88 Emoticon magnets fridge magnets square set of 4 Weight: 32 g/set strength: approx. 650 g</p>	<p>Price in EUR 1 set 9,99/set</p>	<p>Funny little square magnets with emoticons. A tiny magnet is attached to the backside of the symbols. The adhesive force is still impressive: A single magnet holds 8 sheets of A4 paper securely on the whiteboard.</p>

LIV-105 Glass magnets 'Funimals' with funny animal faces set of 4 Weight: 120 g/set strength: approx. 400 g	Price in EUR 1 set 9,99/set	Round glass magnets with the friendly faces of four different forest animals
SALE-092 Glass magnets 'Jardin' with garden motifs set of 4 Weight: 100 g/set	Price in EUR 1 set 4,99/set	For all garden enthusiasts we have beautiful vintage magnets in many different green themes.
SALE-093 Glass magnets 'America' with American motifs set of 4 Weight: 100 g/set	Price in EUR 1 set 4,99/set	Glass magnets with classic American vintage motifs in stylish muted brown and blue shades.
SALE-094 Glass magnets 'Summer' with summer motifs set of 4 Weight: 100 g/set	Price in EUR 1 set 4,99/set	Finally summer! At least when you have these pretty and happy summer-themed glass magnets on your fridge!
SALE-095 Glass magnets 'Bouquet' with flower motifs set of 4 Weight: 100 g/set	Price in EUR 1 set 4,99/set	Cute glass magnets with French vintage flower motifs in bright colours.
LIV-67 Bird magnets bird-shaped fridge magnets set of 6 Weight: 47 g/set strength: approx. 500 g	Price in EUR 1 set 9,99/set	A little (neon) birdie told me... they like to embellish refrigerator, magnetic board or boring iron surfaces and at the same time hold up to 7 sheets of paper.
LIV-64 Cat magnets cat-shaped fridge magnets set of 6 Weight: 68 g/set strength: approx. 500 g	Price in EUR 1 set 9,99/set	Cats always bring luck, no matter if white, black or grey! They are not just cute but also practical and hold your notes and postcards on any metal surface.
LIV-81 Fridge magnets 'Kitty Cat' cat-shaped set of 6 Weight: 26 g/set strength: approx. 500 g	Price in EUR 1 set 9,99/set	6 cute round cat magnets. The ideal addition to article FL-08 (magnets are identical) - especially when you lost those magnets.
LIV-68 Clover magnets clover-shaped fridge magnets set of 4 Weight: 27 g/set strength: approx. 850 g	Price in EUR 1 set 9,99/set	Instead of spending days searching the meadows for a four-leafed lucky charm, we have an elegant solution for you: Magnetic clover leaves that won't wilt and securely hold your notes and messages.

<p>LIV-73 Fridge magnets vintage keys antiqued look set of 5 Weight: 120 g/set strength: approx. 300 g</p>	<p>Price in EUR 1 set 9,99/set</p>	<p>A key for every occasion! Patinated in different colours, they add a vintage look to your fridge or magnetic board.</p>
<p>LIV-74 Fridge magnets vintage bugs antiqued look set of 5 Weight: 190 g/set</p>	<p>Price in EUR 1 set 9,99/set</p>	<p>For bug fans with a knack for bling bling and vintage. These big, shimmering scarabs leave a dazzling impression and definitely stick out!</p>
<p>SALE-103 Fridge magnets 'Ornament Birds' antiqued look set of 6 Weight: 190 g/set</p>	<p>Price in EUR 1 set 4,99/set</p>	<p>Bird magnets made of hand-painted tin in trendy vintage look.</p>
<p>SALE-105 Fridge magnets 'Beetle in Glass' antiqued look set of 2 Weight: 62 g/set</p>	<p>Price in EUR 1 set 4,99/set</p>	<p>Beetle magnets made of hand-painted tin in trendy vintage look.</p>
<p>LIV-97 Concrete magnets in three different shapes set of 4 Weight: 50 g/set strength: approx. 400 g</p>	<p>Price in EUR 1 set 9,99/set</p>	<p>Decorative magnets made of real concrete will make a great impression in your living or office space.</p>
<p>LIV-75 Blackboards mini write-on fridge magnets in second-hand look set of 5 Weight: 320 g/set strength: approx. 650 g</p>	<p>Price in EUR 1 set 9,99/set</p>	<p>No comment? With the magnetic writeable speech bubbles you can leave little messages on the fridge or magnetic board.</p>
<p>LIV-77 People colouring pictures magnetic colour-me fridge magnets set of 5 Weight: 47 g/set strength: approx. 700 g</p>	<p>Price in EUR 1 set 4,99/set</p>	<p>Aah, how peaceful... Why is it so quiet all of a sudden? Of course, the kids are colouring! The colour-me fridge magnets are so popular that you won't hear a peep for half an hour...</p>
<p>LIV-58 Clownfish magnets fish-shaped fridge magnets set of 6 Weight: 53 g/set strength: approx. 550 g</p>	<p>Price in EUR 1 set 9,99/set</p>	<p>Nemo and his friends are looking for a new home. The little magnetic fish prefer a metal surface to a reef or lagoon.</p>
<p>LIV-85 Dinosaur magnets dinosaur-shaped fridge magnets set of 4 Weight: 44 g/set strength: approx. 400 g</p>	<p>Price in EUR 1 set 9,99/set</p>	<p>These dinosaurs are really classy! Triceratops & Co. and their dark shimmering finish and delicate details don't just get young dinosaur fans excited.</p>

<p>LIV-86 Bear magnets bear-shaped fridge magnets set of 6 Weight: 65 g/set strength: approx. 400 g</p>	<p>Price in EUR 1 set 9,99/set</p>	<p>For all fans of teddybears! Six cute magnetic bears in three different colours watch out for your shopping list on the fridge.</p>
<p>LIV-87 Gecko magnets gecko-shaped fridge magnets set of 6 Weight: 66 g/set strength: approx. 400 g</p>	<p>Price in EUR 1 set 9,99/set</p>	<p>Luckily our gecko magnets are not as shy as the real animals and take their note-holding job seriously.</p>
<p>LIV-62 Piggy magnets multi-coloured pig-shaped fridge magnets set of 6 Weight: 57 g/set strength: approx. 500 g</p>	<p>Price in EUR 1 set 9,99/set</p>	<p>6 little piggies! These cute magnetic piggies will hopefully bring us luck in our assortment. Thanks to their bright colours they are the eye-catcher on every magnetic board or fridge.</p>
<p>LIV-53 Ladybird magnets ladybird-shaped fridge magnets set of 6 Weight: 49 g/set strength: approx. 450 g</p>	<p>Price in EUR 1 set 9,99/set</p>	<p>These cute ladybirds made of resin make for nice little lucky charms and are also very practical as magnets.</p>
<p>LIV-57 Butterfly magnets butterfly-shaped fridge magnets set of 4 Weight: 56 g/set strength: approx. 600 g</p>	<p>Price in EUR 1 set 9,99/set</p>	<p>No matter the season, these colourful metal butterflies bring spring fever to your magnetic board.</p>
<p>LIV-50 Fridge magnets 'Fruity' fruit-shaped set of 4 Weight: 40 g/set strength: approx. 500 g</p>	<p>Price in EUR 1 set 4,99/set</p>	<p>Not just for vegans! This colourful fruit looks very tasty, but should rather be used to hang up notes and shopping lists.</p>
<p>SALE-096 Bottle cap magnets "Love" fridge magnets set of 4 Weight: 72 g/set</p>	<p>Price in EUR 1 set 4,99/set</p>	<p>Love, spelled out, in modern bottle cap magnets. And of course super-strong thanks to a neodymium magnet on the backside!</p>
<p>LIV-56 Magnetic words Love words, syllables and punctuation marks 510 pieces available in various languages Weight: 290 g/set</p>	<p>Price in EUR 1 set 19,99/set</p>	<p>A set of magnetic words contains 510 pieces: Words, syllables and punctuation marks. The words printed on magnetic sheet revolve around the topics of love and eroticism.</p>
<p>LIV-109 Mandala hearts magnetic colour-me fridge magnets heart-shaped set of 9 Weight: 190 g/set</p>	<p>Price in EUR 1 set 11,90/set</p>	<p>The newest hype: Colour-me Mandalas! The cute hearts are magnetic and beautify the fridge or the magnetic board. Colour with markers or coloured pencils.</p>

<p>LIV-47 Magnetic words words, syllables and punctuation marks 510 pieces available in various languages Weight: 290 g/set</p>	<p>Price in EUR 1 set 19,99/set</p>	<p>A set of magnetic words contains 510 pieces: Words, syllables and punctuation marks. Available in five languages: German, English, French, Dutch and Spanish</p>
<p>LIV-46 Fridge magnets 'Grand Slam' tennis ball magnets set of 4 Weight: 46 g/set strength: approx. 400 g</p>	<p>Price in EUR 1 set 9,99/set</p>	<p>A must-have for everyone who is passionate about tennis: These funny tennis ball magnets.</p>
<p>LIV-45 Fridge magnets 'Kicker' football magnets set of 4 Weight: 48 g/set strength: approx. 400 g</p>	<p>Price in EUR 1 set 9,99/set</p>	<p>This deco magnet in the shape of a football makes the heart of every football fan skip a beat.</p>
<p>LIV-43 Fridge magnets 'Toadstools' with felt protectors set of 3 Weight: 57 g/set strength: approx. 500 g</p>	<p>Price in EUR 1 set 15,00/set from 3 sets 13,55/set from 10 sets 12,27/set</p>	<p>The carefully crafted super magnets with a toadstool-inspired design help to hold on to important things. And they do it with care: A glued-on felt disc prevents scratches on delicate surfaces.</p>
<p>LIV-42 Felt magnets 'Adams' hand-crafted decorative magnets made of felt and glass beads set of 3 in different colours Weight: 34 g/set strength: approx. 600 g</p>	<p>Price in EUR 1 set 19,02/set from 3 sets 17,45/set from 10 sets 16,02/set</p>	<p>These amazingly colourful and sensual felt magnets spread vitality all around. Each of those colour bursts has been carefully felted by hand. Even the little glass pearls were sewn on by hand.</p>
<p>MANI-01 Fridge magnets 'African animals' magnetic mini animals made from old tin cans sale profits go to Children's Aid Madagascar (Kinderhilfe Madagaskar) Weight: 30 g</p>	<p>Price in EUR 1 pc. 11,90 ea.</p>	<p>These magnetic animals are skilfully crafted in Madagascar from old tin cans. All sales proceeds benefit the children's aid organisation zaza malagasy in Madagascar.</p>
<p>MCAR-01 Fridge magnets 'MadagasCAR' magnetic mini vehicles made of old tin cans sale profits go to Children's Aid Madagascar (Kinderhilfe Madagaskar) Weight: 30 g</p>	<p>Price in EUR 1 pc. 11,90 ea.</p>	<p>These beautiful little cars and planes are manufactured in Madagascar. Handy craftsmen make them with lots of love and creativity out of old tin cans. The entire proceeds from the sale of these little cars and planes go to the Children's Fund in Madagascar.</p>
<p>LIV-38 Decorative magnet 'Diamond Heart' with heart motif, made of plexiglass with Swarovski crystals Weight: 13 g strength: approx. 450 g</p>	<p>Price in EUR 1 pc. 23,45 ea. from 3 pcs. 21,59 ea. from 10 pcs. 19,96 ea.</p>	<p>The sparkling diamond heart is not only a head turner, it also holds on to love notes and other memos. Square.</p>
<p>LIV-39 Decorative magnet 'Lucky Diamond' with four-leaf clover motif, made of plexiglass with Swarovski crystals Weight: 13 g strength: approx. 450 g</p>	<p>Price in EUR 1 pc. 21,95 ea. from 3 pcs. 19,95 ea. from 10 pcs. 18,95 ea.</p>	<p>The first lucky charm magnet! The sparkling four-leaf clover is not only pretty but also useful and a novel gift idea at that.</p>

<p>LIV-40 Decorative magnet 'Diamond Star' with star motif, made of plexiglass with Swarovski crystals Weight: 13 g strength: approx. 450 g</p>	<p>Price in EUR 1 pc. 21,95 ea. from 3 pcs. 19,95 ea. from 10 pcs. 18,95 ea.</p>	<p>The star made of 250 sparkling Swarovski elements is not just for superstars but looks also nice on your refrigerator.</p>
<p>LIV-54 Decorative magnet 'Starfish' made of plexiglass with Swarovski crystals Weight: 9 g strength: approx. 400 g</p>	<p>Price in EUR 1 pc. 21,95 ea. from 3 pcs. 19,95 ea. from 10 pcs. 18,95 ea.</p>	<p>The starfish made of 300 Swarovski elements is not just for superstars, but also looks good on your refrigerator.</p>
<p>LIV-55 Decorative magnet 'Glitter Heart' made of plexiglass with Swarovski crystals Weight: 17 g strength: approx. 450 g</p>	<p>Price in EUR 1 pc. 21,95 ea. from 3 pcs. 19,95 ea. from 10 pcs. 18,95 ea.</p>	<p>The heart made of sparkling Swarovski diamonds is not just a classy eye-catcher, it also holds paper love notes. Heart-shaped.</p>
<p>LIV-14 Magnetic marbles colourful deco magnets made of acrylic glass set of 6 Weight: 35 g/set strength: approx. 500 g</p>	<p>Price in EUR 1 set 9,99/set</p>	<p>They look like marbles but don't roll away thanks to the embedded magnet: Acrylic glass spheres in a set of 6.</p>
<p>LIV-05 Fridge magnets 'Crazy' colourful deco magnets made of acrylic glass set of 6 Weight: 31 g/set strength: approx. 300 g</p>	<p>Price in EUR 1 set 9,99/set</p>	<p>With every set you receive six magnetic buttons with a little psychedelic touch.</p>
<p>LIV-157 Decorative magnets 'Cube Medium' edge length 7 mm set of 6 silver-blue Weight: 46 g/set strength: approx. 300 g</p>	<p>Price in EUR 1 set 11,90/set</p>	<p>The decorative magnets "Cube Medium" by Trendform are something quite special. They reliably hold your notes not only on whiteboards and metal strips but on magnetic glass boards too.</p>
<p>LIV-158 Decorative magnets 'Bolt' Ø 7 mm set of 6 silver-blue Weight: 40 g/set strength: approx. 200 g</p>	<p>Price in EUR 1 set 11,90/set</p>	<p>These compact decorative magnets by Trendform are not only practical but also truly eye-catching, thanks to their silver-blue, slightly shimmering colour.</p>
<p>LIV-159 Decorative magnets 'Kubiq' edge length 5 mm set of 10 silver-blue Weight: 31 g/set strength: approx. 200 g</p>	<p>Price in EUR 1 set 8,80/set</p>	<p>Add a subtle splash of colour to your magnetic board with these small decorative magnets called "Kubiq". The silver-blue magnetic cubes safely hold notes, A4-sheets, postcards etc.</p>
<p>LIV-160 Decorative magnets 'Magnum' Ø 4 mm set of 10 silver-blue Weight: 28 g/set strength: approx. 100 g</p>	<p>Price in EUR 1 set 9,90/set</p>	<p>These mini magnets in silver-blue are practical accessories to have in your office or home. Despite their small size, they still possess an astonishing 100 g adhesive force.</p>

AG-04 Decorative magnets 'Winter Flowers' hand-crafted flower magnets in winter colours made of acrylic glass set of 5 Weight: 25 g/set strength: approx. 1,3 kg	Price in EUR 1 set 19,69/set from 3 sets 18,25/set from 10 sets 16,96/set	The Pril flowers of the new millenium are made of acrylic glass - transparent and very magnetic. The only correct way of posting your yoga appointments on the refrigerator!
AG-03 Decorative magnets 'Summer Flowers' hand-crafted flower magnets in summer colours made of acrylic glass set of 5 Weight: 25 g/set strength: approx. 1,3 kg	Price in EUR 1 set 19,69/set from 3 sets 18,25/set from 10 sets 16,96/set	Cute flower magnets in bright summer colours. Each flower is unique and cut individually by hand. With a holding power of 1 kilo, these magnets are strong enough to hold thicker paper or postcards. Each set contains 5 flower magnets.

School magnets and accessories: Ferrofluid, horseshoe magnet & Co. for

Here you can find everything for physics class: Horseshoe magnets in various sizes, ferro fluid, iron filings, magnetic field detectors, etc.

<p>M-FER-10 Ferrofluid 10 ml magnetic fluid for experiments in PET bottle with pipette Weight: 36 g</p>	<p>Price in EUR</p> <p>1 pc. 12,99 ea. (129,90/100 ml)</p> <p>from 3 pcs. 11,99 ea. (119,90/100 ml)</p> <p>from 10 pcs. 11,09 ea. (110,90/100 ml)</p>	<p>A ferrofluid is a liquid containing very small ferromagnetic particles. Because of these particles the liquid reacts strongly to magnetic fields and behaves strangely inside a magnetic field.</p>
<p>EDU-7 Bar magnet rectangular short 60 x 15 mm AlNiCo5 red-green coated Weight: 37 g</p>	<p>Price in EUR</p> <p>1 pc. 7,57 ea.</p> <p>from 3 pcs. 6,72 ea.</p> <p>from 10 pcs. 5,96 ea.</p> <p>from 20 pcs. 5,59 ea.</p> <p>from 40 pcs. 5,26 ea.</p>	<p>The small AlNiCo bar is 60 mm x 15 mm x 6 mm big and red-green coated. This magnet is suitable to demonstrate the magnetic field of an oblong magnet. The poles lie on the small areas with 15 mm x 6 mm.</p>
<p>EDU-8 Bar magnet rectangular long 100 x 15 mm AlNiCo5 red-green coated Weight: 110 g</p>	<p>Price in EUR</p> <p>1 pc. 16,34 ea.</p> <p>from 3 pcs. 14,66 ea.</p> <p>from 10 pcs. 13,17 ea.</p> <p>from 20 pcs. 12,44 ea.</p> <p>from 40 pcs. 11,80 ea.</p>	<p>The long AlNiCo bar is 100 mm x 15 mm x 10 mm big and red-green coated. This magnet is suitable to demonstrate the magnetic field of an oblong magnet. The poles lie on the small areas with 15 mm x 10 mm.</p>
<p>EDU-9 Rod magnet round 150 x 12 mm AlNiCo5 red-green coated Weight: 120 g</p>	<p>Price in EUR</p> <p>1 pc. 19,92 ea.</p> <p>from 3 pcs. 17,87 ea.</p> <p>from 10 pcs. 16,04 ea.</p> <p>from 20 pcs. 15,15 ea.</p> <p>from 40 pcs. 14,36 ea.</p>	<p>The long AlNiCo rod is 12 mm x 150 mm long and red-green coated. This magnet is suitable to demonstrate the magnetic field of an oblong magnet. The poles lie on the small circular areas.</p>
<p>EDU-3 Horseshoe magnet small 50 x 40 mm AlNiCo5 red-green coated Weight: 62 g</p>	<p>Price in EUR</p> <p>1 pc. 16,17 ea.</p> <p>from 3 pcs. 14,19 ea.</p> <p>from 10 pcs. 12,42 ea.</p> <p>from 20 pcs. 11,56 ea.</p> <p>from 40 pcs. 10,80 ea.</p>	<p>The small AlNiCo horseshoe magnet is 50 mm x 40 mm big and red-green coated. These classic horseshoe style magnets are popular in school experiments.</p>
<p>EDU-4 Horseshoe magnet medium 80 x 60 mm AlNiCo5 red-green coated Weight: 170 g</p>	<p>Price in EUR</p> <p>1 pc. 25,17 ea.</p> <p>from 3 pcs. 22,71 ea.</p> <p>from 10 pcs. 20,51 ea.</p> <p>from 20 pcs. 19,44 ea.</p> <p>from 40 pcs. 18,50 ea.</p>	<p>The medium AlNiCo horseshoe magnet is 80 mm x 60 mm big and red-green coated. You can do various experiments with these classic horseshoe style magnets.</p>
<p>EDU-5 Horseshoe magnet big 100 x 63 mm AlNiCo5 red-green coated Weight: 180 g</p>	<p>Price in EUR</p> <p>1 pc. 25,78 ea.</p> <p>from 3 pcs. 23,27 ea.</p> <p>from 10 pcs. 21,02 ea.</p> <p>from 20 pcs. 19,93 ea.</p> <p>from 40 pcs. 18,97 ea.</p>	<p>This big AlNiCo horseshoe magnet is 100 mm x 63 mm big and red-green coated. A classic magnet for educational use.</p>
<p>EDU-6 Horseshoe magnet tapered 100 x 48 mm AlNiCo5 red-green coated Weight: 110 g</p>	<p>Price in EUR</p> <p>1 pc. 22,00 ea.</p> <p>from 3 pcs. 19,76 ea.</p> <p>from 10 pcs. 17,76 ea.</p> <p>from 20 pcs. 16,79 ea.</p> <p>from 40 pcs. 15,93 ea.</p>	<p>This bent AlNiCo horseshoe magnet is 100 mm x 48 mm big (at the widest spot) and red-green coated. As opposed to our other three horseshoe magnets, the arms of this magnet are not parallel and the ends of the poles are closer together.</p>

<p>M-38 Letters or numbers magnetic set of magnetic symbols made of EVA foam 4 assorted colours Weight: 350 g/set</p>	<p>Price in EUR 1 set 17,37/set</p>	<p>Each box of magnetic letters and numbers contains approx. 100 foam symbols, which contain a magnetic sheet on the back that makes them adhere to metal surfaces, such as blackboards and whiteboards and even magnetic paint.</p>
<p>M-22 Iron filings to make magnetic field lines visible approx. 100 g in a plastic container Weight: 100 g</p>	<p>Price in EUR 1 pc. 7,70 ea. from 3 pcs. 6,88 ea. from 10 pcs. 6,11 ea. from 20 pcs. 5,75 ea. from 40 pcs. 5,43 ea.</p>	<p>Iron filings are the simplest medium to use in making magnetic fields visible. You will receive approx. 100 g in a reclosable plastic container, as pictured.</p>
<p>ST-K-08-N Steel balls 8 mm not magnets! ferromagnetic, nickel-plated Ø 8 mm Weight: 2,1 g</p>	<p>Price in EUR 10 pcs. 0,34 ea. from 40 pcs. 0,29 ea. from 80 pcs. 0,26 ea. from 160 pcs. 0,24 ea.</p>	<p>These are NOT magnets, but nickel-plated steel balls. For combining with other magnets, e.g., with rod magnets.</p>
<p>ST-K-10-N Steel balls 10 mm not magnets! ferromagnetic, nickel-plated Ø 10 mm Weight: 4,2 g</p>	<p>Price in EUR 10 pcs. 0,39 ea. from 40 pcs. 0,32 ea. from 80 pcs. 0,30 ea. from 160 pcs. 0,27 ea.</p>	<p>These are NOT magnets, but nickel-plated steel balls. For combining with other magnets, e.g., with rod magnets.</p>
<p>ST-K-13-N Steel balls 13 mm not magnets! ferromagnetic, nickel-plated Ø 12,7 mm Weight: 8,5 g</p>	<p>Price in EUR 10 pcs. 0,49 ea. from 40 pcs. 0,41 ea. from 80 pcs. 0,38 ea. from 160 pcs. 0,35 ea.</p>	<p>These are NOT magnets, but nickel-plated steel balls. For combining with other magnets, e.g., with rod magnets.</p>
<p>ST-K-20-N Steel balls 20 mm not magnets! ferromagnetic, nickel-plated Ø 20 mm Weight: 33 g</p>	<p>Price in EUR 10 pcs. 1,06 ea. from 40 pcs. 0,88 ea. from 80 pcs. 0,81 ea. from 160 pcs. 0,74 ea.</p>	<p>These are NOT magnets, but nickel-plated steel balls. For combining with other magnets, e.g., with rod magnets.</p>
<p>M-37 Metal discs 35 x 2 mm not magnets! ferromagnetic, nickel-plated set of 20 Weight: 290 g/set</p>	<p>Price in EUR 1 set 8,15/set from 3 sets 7,25/set from 10 sets 6,45/set from 20 sets 6,06/set from 40 sets 5,72/set</p>	<p>20 solid iron metal discs. The metal discs are not magnetic, but a magnet adheres very well to these metal discs. The discs are nickel-plated so they won't rust.</p>
<p>M-04 Flux detector small foil to indicate magnetic fields approx. 75 x 75 mm Weight: 1 g</p>	<p>Price in EUR 1 pc. 7,10 ea. from 3 pcs. 6,33 ea. from 10 pcs. 5,65 ea. from 20 pcs. 5,33 ea. from 40 pcs. 5,02 ea.</p>	<p>This Flux Detector makes magnetic fields visible. It's accomplished by a foil filled with nickel particles in a gelatinous suspension. (see also M-05 and M-08.) Other sizes upon request.</p>
<p>M-05 Flux Detector laminated foil to indicate magnetic fields approx. 75 x 75 mm Weight: 3 g</p>	<p>Price in EUR 1 pc. 8,32 ea. from 3 pcs. 7,42 ea. from 10 pcs. 6,65 ea. from 20 pcs. 6,24 ea. from 40 pcs. 5,92 ea.</p>	<p>The same Flux Detector as Flux detector small, but laminated. This makes the foil less susceptible to cracking but stiffer, so it can no longer be wrapped around magnet systems.</p>

M-08

Flux Detector large
foil to indicate magnetic
fields
approx. 150 x 150 mm
Weight: 4 g

Price in EUR

	1 pc.	18,79 ea.
from	3 pcs.	17,02 ea.
from	10 pcs.	15,39 ea.
from	20 pcs.	14,58 ea.
from	40 pcs.	13,90 ea.

Same article as Flux detector small but with 4 times the surface area. The Flux Detector turns dark in colour when the magnetic field is perpendicular to the foil (for example, near the poles) and turns lighter when the magnetic field runs parallel to the foil.

Magnetic name badges: needle-free attaching

Magnetic name tags have a clear advantage over others that require needles: The clothing won't be damaged and the tags are held in place securely thanks to super magnets. Magnetic name tags are therefore the perfect companion for weddings, congresses or other festive events.

<p>M-35 Name badge magnetic Business name badges with PET card holder including magnet and blank insert set of 10 Weight: 180 g/set</p>	<p>Price in EUR 1 set 22,70/set from 3 sets 19,69/set from 10 sets 16,95/set</p>	<p>At a conference, wedding or birthday party - with this name badge your clients and guests will look their best. This name tag is easy to attach, protects the clothing and assures strong adhesion.</p>
<p>M-17 Name badge magnetic Freestyle set for fastening a name badge 2 parts Weight: 12 g</p>	<p>Price in EUR 5 pcs. 1,33 ea. from 15 pcs. 1,15 ea. from 40 pcs. 1,00 ea. from 80 pcs. 0,92 ea.</p>	<p>The quick solution for magnetic name tags of all kinds - the set spares your clothing since you don't need needles. - Simple assembly, thanks to the existing self-adhesive film - Comfortable to wear (only 12 grammes) - Not suitable for people with pacemakers!</p>
<p>M-34 Blank business cards Avery Zweckform C32011 for magnetic name badges package of 10 sheets Weight: 200 g</p>	<p>Price in EUR 1 pc. 12,61 ea. from 3 pcs. 11,66 ea. from 10 pcs. 10,77 ea. from 20 pcs. 10,38 ea. from 40 pcs. 9,99 ea.</p>	<p>For quick, individual and professional printing of business-card-size cards. Suitable for laser and inkjet printer, makes 100 business cards.</p>

The photo rope - the decorative magnetic photo line

Most photo ropes feature a steel weight and are hung up vertically. The articles FL-04, FL-05 and FL-06 on the other hand have two loops and are normally hung up horizontally between two nails.

<p>FL-02 Photo rope 1,5 with weight with loop and steel weight incl. 15 magnets Weight: 150 g</p>	<p>Price in EUR 1 pc. 16,75 ea. from 3 pcs. 15,07 ea. from 10 pcs. 13,58 ea. from 20 pcs. 12,81 ea. from 40 pcs. 12,18 ea.</p>	<p>This photo rope guarantees a stylish presentation of photos and postcards. A heavy and sturdy steel weight keeps the 2 mm thick steel rope perpendicular.</p>
<p>FL-14 Photo rope "Pearly" 1,5 m with 2 loops incl. 10 magnets Weight: 130 g</p>	<p>Price in EUR 1 pc. 17,45 ea. from 3 pcs. 15,70 ea. from 10 pcs. 14,15 ea. from 20 pcs. 13,40 ea. from 40 pcs. 12,73 ea.</p>	<p>Decorative "pearl" photo rope, 1,5 m, with 2 loops for easy assembly. Includes 10 small neodymium sphere magnets.</p>
<p>FL-05 Photo rope 2 m with 2 loops incl. 20 magnets Weight: 77 g</p>	<p>Price in EUR 1 pc. 13,15 ea. from 3 pcs. 11,79 ea. from 10 pcs. 10,57 ea. from 20 pcs. 10,03 ea. from 40 pcs. 9,48 ea.</p>	<p>2 m long photo rope with 2 loops This version of the photo rope has a loop on both ends but no steel weight. It can be hung horizontally with two nails or screws.</p>
<p>FL-04 Photo rope 1 m with 2 loops incl. 10 magnets Weight: 54 g</p>	<p>Price in EUR 1 pc. 10,64 ea. from 3 pcs. 9,51 ea. from 10 pcs. 8,51 ea. from 20 pcs. 8,01 ea. from 40 pcs. 7,61 ea.</p>	<p>This version of the photo rope has a loop on both ends but no steel weight. It can be hung horizontally with two nails or screws.</p>
<p>FL-03 Photo rope 2 m with weight with loop and steel weight incl. 20 magnets Weight: 160 g</p>	<p>Price in EUR 1 pc. 17,84 ea. from 3 pcs. 16,07 ea. from 10 pcs. 14,44 ea. from 20 pcs. 13,67 ea. from 40 pcs. 12,99 ea.</p>	<p>This version of the photo rope is 2 m long and offers even more room for photos and postcards.</p>
<p>FL-06 Photo rope 3 m with 2 loops incl. 30 magnets Weight: 93 g</p>	<p>Price in EUR 1 pc. 15,35 ea. from 3 pcs. 13,81 ea. from 10 pcs. 12,46 ea. from 20 pcs. 11,78 ea. from 40 pcs. 11,19 ea.</p>	<p>3 m long photo rope with 2 loops This version of the photo rope has a loop on both ends but no steel weight.</p>
<p>FL-10 Photo rope "Sweetheart" 1,5 m with loop and steel weight incl. 8 heart magnets Weight: 70 g</p>	<p>Price in EUR 1 pc. 17,44 ea. from 3 pcs. 15,70 ea. from 10 pcs. 14,15 ea. from 20 pcs. 13,40 ea. from 40 pcs. 12,73 ea.</p>	<p>1,5 m long photo rope with 8 cute and magnetic metal hearts. For the sweetest photos and cards!</p>
<p>FL-08 Photo rope "Kitty Cat" 1,5 m with loop and steel weight incl. 8 cat magnets Weight: 74 g</p>	<p>Price in EUR 1 pc. 17,45 ea. from 3 pcs. 15,71 ea. from 10 pcs. 14,16 ea. from 20 pcs. 13,40 ea. from 40 pcs. 12,73 ea.</p>	<p>A must-have for cat lovers. Delivery includes eight little cat magnets and a 1.5 m long steel rope with weight.</p>

FL-12 Photo rope "Timi" 1,5 m with loop and steel weight length 1,5 m incl. 8 little sheep magnets Weight: 74 g	Price in EUR 1 pc. 17,44 ea. from 3 pcs. 15,70 ea. from 10 pcs. 14,15 ea. from 20 pcs. 13,40 ea. from 40 pcs. 12,73 ea.	The 8 sheep on this photo rope hold your favourite photos securely in the desired position.
FL-13 Photo rope "Star" 1,5 m with loop and steel weight incl. 8 star magnets Weight: 84 g	Price in EUR 1 pc. 17,46 ea. from 3 pcs. 15,67 ea. from 10 pcs. 14,07 ea. from 20 pcs. 13,30 ea. from 40 pcs. 12,61 ea.	The 8 stars of this photo rope hold your favourite photos secure at the desired position.
FL-09 Photo rope "Kolor Klip" 1,5 m with two loops incl. 10 pins not magnetic! Weight: 16 g	Price in EUR 1 pc. 16,04 ea. from 3 pcs. 14,39 ea. from 10 pcs. 12,91 ea. from 20 pcs. 12,19 ea. from 40 pcs. 11,55 ea.	You probably won't be able to hang up laundry on these colourful wooden pegs, but postcards, love notes and recipes instead. Please note: This photo rope does not come with magnets!

Picture frames with magnetic catch

FRM-10 Picture frame 21 x 15 cm with magnetic catch made of transparent acrylic glass for portrait or landscape format Weight: 1,1 kg	Price in EUR 1 pc. 39,99 ea.	The same picture frame as Picture frame 18 x 13 cm, but larger and therefore suitable for photos up to 21,1 x 14,9 cm (DIN A5).
FRM-03 Picture frame 18 x 13 cm with magnetic catch made of transparent acrylic glass for portrait or landscape format Weight: 830 g	Price in EUR 1 pc. 33,14 ea.	The same picture frame as Picture frame 11,5 x 9 cm, but bigger and therefore suitable for pictures of up to 17,8 x 12,7 cm.
FRM-02 Picture frame 15 x 11,5 cm with magnetic catch made of transparent acrylic glass for portrait or landscape format Weight: 510 g	Price in EUR 1 pc. 20,27 ea.	The same picture frame as Picture frame 11,5 x 9 cm, but bigger and therefore suitable for pictures of up to 15 x 11,5 cm.
FRM-01 Picture frame 11,5 x 9 cm with magnetic catch made of transparent acrylic glass for portrait or landscape format Weight: 310 g	Price in EUR 1 pc. 14,54 ea.	This acrylic picture frame shows the best side of your pictures. Portrait or landscape format - the stable frame stands sturdy on its broad, polished sides. Thanks to the magnets sunk into the corners, the frame can be opened and closed in no time.
FRM-09 Picture frame 7 x 5 cm with magnetic catch made of transparent acrylic glass for portrait or landscape format Weight: 90 g	Price in EUR 1 pc. 9,99 ea.	This acrylic picture frame shows the best side of your pictures. Portrait or landscape format - the stable frame stands sturdy on its broad, polished sides. Thanks to the magnets sunk into the corners, the frame can be opened and closed in no time.

Magnetic key racks & key holder

Practical and original key holder to keep your keys and other small ferromagnetic objects. Modern keys are not magnetic, but the mailbox key or the keyring usually adhere well, which also 'glues' the rest of them to the holder.

FO-1 Key rack magnetic 32 cm magnetic strip made of stainless steel for 6 keys Weight: 160 g	Price in EUR 1 pc. 16,00 ea.	Magnetic key rack made of solid brushed stainless steel (1,5 mm thick). The usable surface is 32 x 3,5 cm. Installation parts included.
FO-2 Key rack magnetic 50 cm magnetic strip made of stainless steel for 11 keys Weight: 250 g	Price in EUR 1 pc. 22,00 ea.	The larger version of Key rack magnetic 32 cm. 50 instead of 32 cm long and with 11 magnetic docks for keys. Installation material (3 magnetic wall pins) is included.
FO-3 Key rack magnetic 32 cm magnetic strip made of pear wood for 6 keys Weight: 160 g	Price in EUR 1 pc. 17,00 ea.	Magnetic key rack made of solid oiled peartree wood.
FO-7 Key rack magnetic extra strong stainless steel with felt coating for 8 keys Weight: 680 g	Price in EUR 1 pc. 49,99 ea.	Magnetic key rack in a league of its own. Eight powerful magnets on the back of the steel plate (25 x 15 cm) guarantee a rock-solid hold on your keys. Thanks to a black felt cover, even throwing keys at the rack from a distance will not damage it.

Knife racks & knife blocks with strong magnetic power

Magnetic knife strips and magnetic knife blocks are nicely shaped and practical kitchen accessories. Knives adhere thanks to embedded neodymium magnets and don't have to be stored in the drawer anymore where they can easily become dull and scratched.

<p>FO-10 Knife rack magnetic 32 cm magnetic strip made of stainless steel for 6 knives up to 500 g Weight: 300 g</p>	<p>Price in EUR 1 pc. 22,00 ea.</p>	<p>Magnetic knife rack made of solid brushed V2A stainless steel (1,5 mm thick). The usable area is 32 x 3,5 cm. The mounting accessories are included in the delivery.</p>
<p>FO-11 Knife rack magnetic 50 cm magnetic strip made of stainless steel for 9 knives up to 500 g Weight: 400 g</p>	<p>Price in EUR 1 pc. 29,00 ea.</p>	<p>Magnetic knife rack made of solid brushed V2A stainless steel (1,5 mm thick). The usable area is 50 x 3,5 cm. The mounting accessories are included in the delivery.</p>
<p>M-KNIFEP-001 Knife rack magnetic 45 cm magnetic strip made of wood for knives up to 500 g Weight: 590 g</p>	<p>Price in EUR 1 pc. 69,25 ea.</p>	<p>Store your special knives on one of these classy knife strips. These eye-catchers are carefully processed and contain strong block magnets.</p>
<p>M-KNIFEB-001 Knife block magnetic Modular made of wood for knives up to 900 g Weight: 2,4 kg/set</p>	<p>Price in EUR 1 set 126,98/set from 3 sets 123,07/set</p>	<p>The modular knife block has three wooden parts and can be arranged however you choose. You can securely attach at least 10 knives with a weight of up to 900 g.</p>
<p>M-KNIFEB-002 Knife block magnetic Pentagon made of wood for knives up to 900 g Weight: 1,8 kg</p>	<p>Price in EUR 1 pc. 99,99 ea.</p>	<p>Your knives seem to float on the "Pentagon". Thanks to the extremely strong embedded magnets, you can safely attach at least 8 knives with a weight of up to 900 g.</p>
<p>M-KNIFES-001 Breakfast board set cutting board made of beechwood with magnetic knife holder & PanoramaKnife Weight: 370 g/set</p>	<p>Price in EUR 1 set 99,95/set</p>	<p>The perfect set for a breakfast, snack, picnic or hiking break. Features a breakfast knife and a beechwood board with magnetic knife holder, original by PanoramaKnife Switzerland.</p>

Magnetic board - the multi-functional fancy pin board

Magnetic boards are the perfect presentation surface for postcards, drawings, etc. Many products include suitable neodymium magnets.

<p>GMBB-2060 Magnetic glass board rectangular 20 x 60 cm in different colours Weight: 1,4 kg</p>	<p>Price in EUR 1 pc. 24,99 ea.</p>	<p>Rectangular magnetic glass board made of hardened safety glass. Can be attached with pre-assembled wall mounting on the backside. Wall mounting set and mounting instructions enclosed.</p>
<p>GMBB-4550 Magnetic glass board square 45 x 50 cm in different colours Weight: 2,7 kg</p>	<p>Price in EUR 1 pc. 29,99 ea.</p>	<p>Square magnetic glass board made of hardened safety glass. Can be attached with pre-assembled wall mounting on the backside. Wall mounting set and mounting instructions enclosed.</p>
<p>MB-11 Magnetic board square made from 0,8 mm thick steel sheet 40 x 40 cm in different colours Weight: 1,2 kg</p>	<p>Price in EUR 1 pc. 26,45 ea. from 3 pcs. 24,04 ea. from 10 pcs. 21,89 ea. from 20 pcs. 20,85 ea. from 40 pcs. 19,92 ea.</p>	<p>A classy square magnetic board, available in several styles: black or white powder coating or simply stainless steel.</p>
<p>FO-8 Magnetic board slate classy and exclusive 40 x 20 cm incl. 10 strong magnets Weight: 2,2 kg</p>	<p>Price in EUR 1 pc. 40,00 ea.</p>	<p>Noble wall panel with blue-grey slate surface. 40 cm x 20 cm, made from slate from the Mosel river area, with character line (wall distance about 1 cm). Easy assembly, in portrait and landscape format. Every one of those pieces is unique.</p>
<p>FO-9 Stainless steel discs self-adhesive self-adhesive surface for magnets set of 10 Weight: 2 g/set</p>	<p>Price in EUR 1 set 6,67/set from 3 sets 5,80/set from 10 sets 5,02/set from 20 sets 4,65/set from 40 sets 4,31/set</p>	<p>The world's smallest magnetic board! 10 stainless steel discs, diameter 15 mm, height 0,4 mm with self-adhesive foil on the back side. Magnets are not included.</p>

Magnetic paint, whiteboard and blackboard paint - for creative & magnetic wall

With magnetic paint you can turn any surface into a magnetic wall. Paint the wall or the desired wall portion with magnetic paint at least two times. Then, paint over the grey magnetic paint with the paint of your choice. And there you have your own individual magnetic wall!

<p>M-MP-500 Magnetic paint S 0,5 litre paint grey for an area of 1-1,5 m² Weight: 1,2 kg</p>	<p>Price in EUR</p> <table> <tr> <td></td> <td>1 pc.</td> <td>25,00 ea.</td> <td>(50,00/litre)</td> </tr> <tr> <td>from</td> <td>3 pcs.</td> <td>22,60 ea.</td> <td>(45,20/litre)</td> </tr> <tr> <td>from</td> <td>10 pcs.</td> <td>20,40 ea.</td> <td>(40,80/litre)</td> </tr> <tr> <td>from</td> <td>20 pcs.</td> <td>19,35 ea.</td> <td>(38,70/litre)</td> </tr> </table>		1 pc.	25,00 ea.	(50,00/litre)	from	3 pcs.	22,60 ea.	(45,20/litre)	from	10 pcs.	20,40 ea.	(40,80/litre)	from	20 pcs.	19,35 ea.	(38,70/litre)	<p>This magnetic paint is the latest rage! It transforms any surface into a magnetic wall, be it an actual wall or part of it, a door or a piece of furniture.</p>
	1 pc.	25,00 ea.	(50,00/litre)															
from	3 pcs.	22,60 ea.	(45,20/litre)															
from	10 pcs.	20,40 ea.	(40,80/litre)															
from	20 pcs.	19,35 ea.	(38,70/litre)															
<p>M-MP-1000 Magnetic paint M 1 litre paint grey for an area of 2-3 m² Weight: 2,4 kg</p>	<p>Price in EUR</p> <table> <tr> <td></td> <td>1 pc.</td> <td>44,20 ea.</td> <td>(44,20/litre)</td> </tr> <tr> <td>from</td> <td>3 pcs.</td> <td>39,70 ea.</td> <td>(39,70/litre)</td> </tr> <tr> <td>from</td> <td>10 pcs.</td> <td>35,70 ea.</td> <td>(35,70/litre)</td> </tr> <tr> <td>from</td> <td>20 pcs.</td> <td>33,75 ea.</td> <td>(33,75/litre)</td> </tr> </table>		1 pc.	44,20 ea.	(44,20/litre)	from	3 pcs.	39,70 ea.	(39,70/litre)	from	10 pcs.	35,70 ea.	(35,70/litre)	from	20 pcs.	33,75 ea.	(33,75/litre)	<p>This magnetic paint is the latest rage! It transforms any surface into a magnetic wall, be it an actual wall or part of it, a door or a piece of furniture.</p>
	1 pc.	44,20 ea.	(44,20/litre)															
from	3 pcs.	39,70 ea.	(39,70/litre)															
from	10 pcs.	35,70 ea.	(35,70/litre)															
from	20 pcs.	33,75 ea.	(33,75/litre)															
<p>M-MP-2500 Magnetic paint L 2,5 litre paint grey for an area of 5-7,5 m² Weight: 6 kg</p>	<p>Price in EUR</p> <table> <tr> <td></td> <td>1 pc.</td> <td>79,20 ea.</td> <td>(31,68/litre)</td> </tr> <tr> <td>from</td> <td>3 pcs.</td> <td>72,15 ea.</td> <td>(28,86/litre)</td> </tr> <tr> <td>from</td> <td>10 pcs.</td> <td>65,85 ea.</td> <td>(26,34/litre)</td> </tr> <tr> <td>from</td> <td>20 pcs.</td> <td>62,80 ea.</td> <td>(25,12/litre)</td> </tr> </table>		1 pc.	79,20 ea.	(31,68/litre)	from	3 pcs.	72,15 ea.	(28,86/litre)	from	10 pcs.	65,85 ea.	(26,34/litre)	from	20 pcs.	62,80 ea.	(25,12/litre)	<p>This magnetic paint is the latest rage! It transforms any surface into a magnetic wall, be it an actual wall or part of it, a door or a piece of furniture.</p>
	1 pc.	79,20 ea.	(31,68/litre)															
from	3 pcs.	72,15 ea.	(28,86/litre)															
from	10 pcs.	65,85 ea.	(26,34/litre)															
from	20 pcs.	62,80 ea.	(25,12/litre)															
<p>M-MP-4000 Magnetic paint XL 4 litre paint grey for an area of 8-12 m² Weight: 9,6 kg</p>	<p>Price in EUR</p> <table> <tr> <td></td> <td>1 pc.</td> <td>112,80 ea.</td> <td>(28,20/litre)</td> </tr> <tr> <td>from</td> <td>3 pcs.</td> <td>103,40 ea.</td> <td>(25,85/litre)</td> </tr> <tr> <td>from</td> <td>10 pcs.</td> <td>95,05 ea.</td> <td>(23,76/litre)</td> </tr> <tr> <td>from</td> <td>20 pcs.</td> <td>91,00 ea.</td> <td>(22,75/litre)</td> </tr> </table>		1 pc.	112,80 ea.	(28,20/litre)	from	3 pcs.	103,40 ea.	(25,85/litre)	from	10 pcs.	95,05 ea.	(23,76/litre)	from	20 pcs.	91,00 ea.	(22,75/litre)	<p>This magnetic paint is the latest rage! It transforms any surface into a magnetic wall, be it an actual wall or part of it, a door or a piece of furniture.</p>
	1 pc.	112,80 ea.	(28,20/litre)															
from	3 pcs.	103,40 ea.	(25,85/litre)															
from	10 pcs.	95,05 ea.	(23,76/litre)															
from	20 pcs.	91,00 ea.	(22,75/litre)															
<p>M-WP-1000 Whiteboard paint L 1litre for an area of 6 m² white or transparent not magnetic! Weight: 1,2 kg</p>	<p>Price in EUR</p> <table> <tr> <td></td> <td>1 pc.</td> <td>89,99 ea.</td> <td>(89,99/litre)</td> </tr> <tr> <td>from</td> <td>3 pcs.</td> <td>85,99 ea.</td> <td>(85,99/litre)</td> </tr> <tr> <td>from</td> <td>10 pcs.</td> <td>82,42 ea.</td> <td>(82,42/litre)</td> </tr> <tr> <td>from</td> <td>20 pcs.</td> <td>80,68 ea.</td> <td>(80,68/litre)</td> </tr> </table>		1 pc.	89,99 ea.	(89,99/litre)	from	3 pcs.	85,99 ea.	(85,99/litre)	from	10 pcs.	82,42 ea.	(82,42/litre)	from	20 pcs.	80,68 ea.	(80,68/litre)	<p>Turn every smooth surface into a dry-wipe whiteboard - whether it is a large wall, a door, a cupboard or an old blackboard.</p>
	1 pc.	89,99 ea.	(89,99/litre)															
from	3 pcs.	85,99 ea.	(85,99/litre)															
from	10 pcs.	82,42 ea.	(82,42/litre)															
from	20 pcs.	80,68 ea.	(80,68/litre)															
<p>SF-ADH-001 superflex vinyl wallpaper paste special adhesive for superflex wallpapers and films for a surface area of approx. 20 m² Weight: 5 kg</p>	<p>Price in EUR</p> <table> <tr> <td></td> <td>1 pc.</td> <td>54,90 ea.</td> <td>(10,98/litre)</td> </tr> <tr> <td>from</td> <td>3 pcs.</td> <td>50,90 ea.</td> <td>(10,18/litre)</td> </tr> </table>		1 pc.	54,90 ea.	(10,98/litre)	from	3 pcs.	50,90 ea.	(10,18/litre)	<p>The superflex wallpaper paste is a special adhesive specifically developed for use with superflex wallpapers.</p>								
	1 pc.	54,90 ea.	(10,98/litre)															
from	3 pcs.	50,90 ea.	(10,18/litre)															
<p>SF-PL-5000 superflex magnetic plaster 10 kg black for a surface area of 6 m² Weight: 10 kg</p>	<p>Price in EUR</p> <table> <tr> <td></td> <td>1 pc.</td> <td>129,00 ea.</td> <td>(25,80/kg)</td> </tr> <tr> <td>from</td> <td>3 pcs.</td> <td>119,00 ea.</td> <td>(23,80/kg)</td> </tr> <tr> <td>from</td> <td>5 pcs.</td> <td>109,00 ea.</td> <td>(21,80/kg)</td> </tr> </table>		1 pc.	129,00 ea.	(25,80/kg)	from	3 pcs.	119,00 ea.	(23,80/kg)	from	5 pcs.	109,00 ea.	(21,80/kg)	<p>Colour: Black Yield: 5 m² (two coats)</p>				
	1 pc.	129,00 ea.	(25,80/kg)															
from	3 pcs.	119,00 ea.	(23,80/kg)															
from	5 pcs.	109,00 ea.	(21,80/kg)															
<p>SF-PRI-001 superflex primer for superflex products white, 750 ml for a surface area of approx. 6 m² Weight: 1,1 kg</p>	<p>Price in EUR</p> <table> <tr> <td></td> <td>1 pc.</td> <td>24,90 ea.</td> <td>(4,98/litre)</td> </tr> <tr> <td>from</td> <td>3 pcs.</td> <td>22,90 ea.</td> <td>(4,58/litre)</td> </tr> <tr> <td>from</td> <td>5 pcs.</td> <td>20,90 ea.</td> <td>(4,18/litre)</td> </tr> </table>		1 pc.	24,90 ea.	(4,98/litre)	from	3 pcs.	22,90 ea.	(4,58/litre)	from	5 pcs.	20,90 ea.	(4,18/litre)	<p>The superflex primer ensures that surfaces made of wood, plaster or metal are properly sealed. As a result, products such as magnetic plaster, magnetic wallpaper and film wallcoverings adhere well to the treated surface.</p>				
	1 pc.	24,90 ea.	(4,98/litre)															
from	3 pcs.	22,90 ea.	(4,58/litre)															
from	5 pcs.	20,90 ea.	(4,18/litre)															

<p>M-WP-500 Whiteboard paint S 500 ml for an area of 3 m² white or transparent not magnetic! Weight: 670 g</p>	<p>Price in EUR</p> <table> <tr> <td></td> <td>1 pc.</td> <td>49,99 ea.</td> <td>(99,98/litre)</td> </tr> <tr> <td>from</td> <td>3 pcs.</td> <td>48,21 ea.</td> <td>(96,42/litre)</td> </tr> <tr> <td>from</td> <td>10 pcs.</td> <td>46,62 ea.</td> <td>(93,24/litre)</td> </tr> <tr> <td>from</td> <td>20 pcs.</td> <td>45,85 ea.</td> <td>(91,70/litre)</td> </tr> </table>		1 pc.	49,99 ea.	(99,98/litre)	from	3 pcs.	48,21 ea.	(96,42/litre)	from	10 pcs.	46,62 ea.	(93,24/litre)	from	20 pcs.	45,85 ea.	(91,70/litre)	<p>Turn every smooth surface into a dry-wipe whiteboard - whether it is a large wall, a door, a cupboard or an old blackboard.</p>
	1 pc.	49,99 ea.	(99,98/litre)															
from	3 pcs.	48,21 ea.	(96,42/litre)															
from	10 pcs.	46,62 ea.	(93,24/litre)															
from	20 pcs.	45,85 ea.	(91,70/litre)															
<p>M-BP-375 Chalkboard paint S 375 ml for an area of 3 m² black or green not magnetic! Weight: 530 g</p>	<p>Price in EUR</p> <table> <tr> <td></td> <td>1 pc.</td> <td>13,64 ea.</td> <td>(36,37/litre)</td> </tr> <tr> <td>from</td> <td>3 pcs.</td> <td>12,53 ea.</td> <td>(33,41/litre)</td> </tr> <tr> <td>from</td> <td>10 pcs.</td> <td>11,54 ea.</td> <td>(30,77/litre)</td> </tr> <tr> <td>from</td> <td>20 pcs.</td> <td>11,05 ea.</td> <td>(29,47/litre)</td> </tr> </table>		1 pc.	13,64 ea.	(36,37/litre)	from	3 pcs.	12,53 ea.	(33,41/litre)	from	10 pcs.	11,54 ea.	(30,77/litre)	from	20 pcs.	11,05 ea.	(29,47/litre)	<p>The blackboard paint is a special varnish that creates surfaces you can write on with chalk. Available in black and green.</p>
	1 pc.	13,64 ea.	(36,37/litre)															
from	3 pcs.	12,53 ea.	(33,41/litre)															
from	10 pcs.	11,54 ea.	(30,77/litre)															
from	20 pcs.	11,05 ea.	(29,47/litre)															
<p>M-BP-750 Chalkboard paint L 750 ml for an area of 6 m² black or green not magnetic! Weight: 1 kg</p>	<p>Price in EUR</p> <table> <tr> <td></td> <td>1 pc.</td> <td>22,93 ea.</td> <td>(30,57/litre)</td> </tr> <tr> <td>from</td> <td>3 pcs.</td> <td>21,19 ea.</td> <td>(28,25/litre)</td> </tr> <tr> <td>from</td> <td>10 pcs.</td> <td>19,64 ea.</td> <td>(26,19/litre)</td> </tr> <tr> <td>from</td> <td>20 pcs.</td> <td>18,88 ea.</td> <td>(25,17/litre)</td> </tr> </table>		1 pc.	22,93 ea.	(30,57/litre)	from	3 pcs.	21,19 ea.	(28,25/litre)	from	10 pcs.	19,64 ea.	(26,19/litre)	from	20 pcs.	18,88 ea.	(25,17/litre)	<p>The blackboard paint is a special varnish that creates surfaces you can write on with chalk. Available in black and green.</p>
	1 pc.	22,93 ea.	(30,57/litre)															
from	3 pcs.	21,19 ea.	(28,25/litre)															
from	10 pcs.	19,64 ea.	(26,19/litre)															
from	20 pcs.	18,88 ea.	(25,17/litre)															

Magnetic memo holders: beastly strong note holders

Thanks to neodymium magnets, these colourful magnetic memo holders stick together. Separate the magnetic animals and place a note, photo, business card, name tag, etc. in between. A cute and practical eye-catcher!

ANI-05 Travis magnetic memo holder Penugin Weight: 70 g	Price in EUR 1 pc. 3,99 ea.	You can rip off this acrylic resin penguin's head and pinch a business card or note in between.
ANI-03 Rhino magnetic memo holder Rhino Weight: 60 g	Price in EUR 1 pc. 3,99 ea.	The peaceful thick-skinned fellow fits well into home and office and makes sure nothing will be forgotten.
ANI-02 Piggy magnetic memo holder Pig Weight: 63 g	Price in EUR 1 pc. 3,99 ea.	Piglet Piggy looks at the world with the stoicism and calmness of a zen master, despite its not very diversified function as a memo holder. Get inspired!
ANI-01 Jumbo magnetic memo holder Elephant Weight: 56 g	Price in EUR 1 pc. 3,99 ea.	The cute elephant sucks everything up with his trunk.
ANI-09 Coco magnetic memo holder Monkey Weight: 56 g	Price in EUR 1 pc. 3,99 ea.	Coco the monkey likes notes better than bananas!

Whiteboard & whiteboard foil - the practical, wipeable writing and organizational

<p>SF-OF1 superflex whiteboard sheet self-adhesive 10 m², white dry-erase not a surface for magnets Weight: 6 kg</p>	<p>Price in EUR 1 pc. 269,00 ea. from 3 pcs. 249,00 ea.</p>	<p>The self-adhesive whiteboard sheet by superflex allows you to turn smooth surfaces such as tables, doors, partitions and other furniture into writing surfaces.</p>
<p>SF-WC1-M superflex magnetic wallpaper 10 m² white ferromagnetic Weight: 15 kg</p>	<p>Price in EUR 1 pc. 349,00 ea. from 3 pcs. 319,00 ea.</p>	<p>With this magnetic wallpaper, you can transform an ordinary wall into a practical magnetic surface. The magnetic wallpaper is ready for use just 48 hours after it has been applied.</p>
<p>SF-WC2-MD superflex 2-in-1 wallpaper 10 m² glossy white ferromagnetic, dry erase Weight: 15 kg</p>	<p>Price in EUR 1 pc. 599,00 ea. from 3 pcs. 579,00 ea. from 5 pcs. 549,00 ea.</p>	<p>Whiteboard and magnetic wallpaper in one. The 2-in-1 wallpaper can be written on with whiteboard markers. With magnets, documents, notes, plans, etc. can be attached to this wallcovering as well.</p>
<p>SF-WC3-MDP superflex 3-in-1 wallpaper 10 m² matt white ferromagnetic, dry-erase, projection screen Weight: 15 kg</p>	<p>Price in EUR 1 pc. 699,00 ea. from 3 pcs. 669,00 ea. from 5 pcs. 629,00 ea.</p>	<p>superflex 3-in-1 wallpaper: whiteboard wallpaper, magnetic wallpaper and projection screen wallpaper in one. It transforms any wall into a high-performance surface and offers you many possible uses.</p>
<p>FS-100500MWBM Whiteboard sheet ferromagnetic surface for magnets 1 x 5 m roll Weight: 8,2 kg</p>	<p>Price in EUR 1 pc. 134,95 ea.</p>	<p>With this glossy whiteboard sheet (a white iron sheet) you can turn an iron surface into a magnetic whiteboard in no time. Just cut the sheet to the desired size and attach it to an smooth surface (Please note: Sheet is not self-adhesive).</p>
<p>MWB-4560 Whiteboard 45 x 60 cm surface for magnets writable with chalk markers Weight: 1,3 kg</p>	<p>Price in EUR 1 pc. 24,99 ea.</p>	<p>A classic for sketching and planning: Even in these digital days, every conference room needs a whiteboard.</p>
<p>MWB-3045 Whiteboard 30 x 45 cm surface for magnets writable with chalk markers Weight: 770 g</p>	<p>Price in EUR 1 pc. 19,99 ea.</p>	<p>A classic for sketching and planning: Even in these digital days, every conference room needs a whiteboard.</p>
<p>KMWB-2435 Children's whiteboard 24 x 35 cm surface for magnets for drawing, playing, writing & learning single-sided use Weight: 210 g</p>	<p>Price in EUR 1 pc. 5,85 ea.</p>	<p>For drawing, playing, writing and playing in school or at home - for children 3 years and up. Writable on one side.</p>

KMWB-2840 Children's whiteboard 28 x 40 cm surface for magnets for drawing, playing, writing & learning usable on both sides Weight: 370 g	Price in EUR 1 pc. 12,05 ea.	For drawing, playing, writing and learning in school and at home - for children 3 years and up. Writable on both sides.
FS-100500MWBG-STIC Whiteboard sheet self-adhesive ferromagnetic surface for magnets 1 x 5 m roll Weight: 8,2 kg	Price in EUR 1 pc. 149,98 ea.	With this self-adhesive whiteboard sheet you can easily make a whiteboard in no time. Simply cut the sheet to the desired size, remove the protective film and attach the sheet to a smooth surface.
DC-2A4 Display case 2 x A4 for 2 A4 sheets extra-flat design with lock Weight: 1,6 kg	Price in EUR 1 pc. 63,07 ea.	This display case is ideal to share information in apartment buildings, schools, companies, etc. The display window has room for 2 A4 sheets of paper next to each other. Thanks to the very flat design the case doesn't protrude into the room.
DC-4A4 Display case 4 x A4 for 4 A4 sheets extra-flat design with lock Weight: 2,4 kg	Price in EUR 1 pc. 101,30 ea.	This display case is ideal to share information in apartment buildings, schools, companies, etc. The display window has room for 4 A4 sheets of paper next to each other. Thanks to the very flat design the case doesn't protrude into the room.

Whiteboard accessories: Practical equipment for office and school

Here you can find everything you need for working on a whiteboard: Whiteboard markers to write-on or draw, magnetic dry eraser & marker holder, as well as coloured and white chalk. The whiteboard markers and chalk markers can also be used for magnetic glass boards.

<p>BA-021 Chalk Marker for magnetic glass boards and whiteboards in different colours set of 4 Weight: 100 g/set</p>	<p>Price in EUR 1 set 14,99/set</p>	<p>The chalk markers of the uni brand come in a set of 4 and are ideal for writing on smooth surfaces such as boards, windows, glass, plastic, and metal.</p>
<p>MP-A4 Magnetic pouch A4 for office and workshop A4 format Weight: 250 g</p>	<p>Price in EUR 1 pc. 5,50 ea. from 3 pcs. 4,92 ea. from 10 pcs. 4,40 ea. from 20 pcs. 4,15 ea. from 40 pcs. 3,92 ea.</p>	<p>Transparent, soft magnetic pouch in A4 format, attached to a strong magnetic sheet. The ideal organiser for office, workshop, warehouse, or kitchen.</p>
<p>MP-A5 Magnetic pouch A5 for office and workshop A5 format Weight: 85 g</p>	<p>Price in EUR 1 pc. 4,11 ea. from 3 pcs. 3,65 ea. from 10 pcs. 3,24 ea. from 20 pcs. 3,04 ea. from 40 pcs. 2,86 ea.</p>	<p>Transparent, soft magnetic pouch in A5 format, attached to a strong magnetic sheet. The ideal organiser for office, workshop, warehouse, or kitchen.</p>
<p>BA-017 Whiteboard cleaner spray in plastic pump bottle 250 ml Weight: 280 g</p>	<p>Price in EUR 1 pc. 9,99 ea. (4,00/100 ml)</p>	<p>Whiteboard cleaner, 250 ml spray bottle. For a thorough cleaning of whiteboards, magnetic glass boards, and other writeable surfaces.</p>
<p>BA-016 Magnet symbols Smiley for whiteboards & planning boards 6 smileys per A5 sheet set of 3: green, yellow, red Weight: 370 g/set</p>	<p>Price in EUR 1 set 8,93/set from 3 sets 7,71/set from 10 sets 6,61/set from 20 sets 6,08/set from 40 sets 5,61/set</p>	<p>Large magnetic smiley symbols in three colours and moods. Made of colourful magnetic sheets they serve as eye-catchers or to highlight content on whiteboards and other magnetic surfaces.</p>
<p>BA-014AR Magnetic symbols Arrow large for whiteboards & planning boards, write-on 8 symbols per A4 sheet in different colours Weight: 240 g/set</p>	<p>Price in EUR 1 set 4,53/set from 3 sets 3,94/set from 10 sets 3,42/set from 20 sets 3,16/set from 40 sets 2,94/set</p>	<p>Large magnetic arrow symbols in various colours serve as eye-catchers or to highlight content on whiteboards and other magnetic surfaces.</p>
<p>BA-014CI Magnetic symbols Circle large for whiteboards & planning boards, write-on 12 symbols per A4 sheet in different colours Weight: 240 g/set</p>	<p>Price in EUR 1 set 4,53/set from 3 sets 3,94/set from 10 sets 3,42/set from 20 sets 3,16/set from 40 sets 2,94/set</p>	<p>Large magnetic circle symbols in various colours serve as eye-catchers or to highlight content on whiteboards and other magnetic surfaces.</p>
<p>BA-014BO Magnetic symbols Speech Bubble, oval for whiteboards & planning boards, write-on 10 symbols per A4 sheet in different colours Weight: 240 g/set</p>	<p>Price in EUR 1 set 4,53/set from 3 sets 3,94/set from 10 sets 3,42/set from 20 sets 3,16/set from 40 sets 2,94/set</p>	<p>Magnetic oval speech bubble symbols made of colourful magnetic sheets serve as eye-catchers or to highlight content on whiteboards and other magnetic surfaces.</p>

<p>BA-014BR Magnetic symbols Speech Bubble, rectangular for whiteboards & planning boards, write-on 10 symbols per A4 sheet in different colours Weight: 240 g/set</p>	<p>Price in EUR 1 set 4,53/set from 3 sets 3,94/set from 10 sets 3,42/set from 20 sets 3,16/set from 40 sets 2,94/set</p>	<p>Magnetic rectangular speech bubble symbols made of colourful magnetic sheets serve as eye-catchers or to highlight content on whiteboards and other magnetic surfaces.</p>
<p>BA-014CL Magnetic symbols Cloud for whiteboards & planning boards, write-on 10 symbols per A4 sheet in different colours Weight: 240 g/set</p>	<p>Price in EUR 1 set 4,53/set from 3 sets 3,94/set from 10 sets 3,42/set from 20 sets 3,16/set from 40 sets 2,94/set</p>	<p>Large magnetic cloud symbols made of colourful magnetic sheets serve as eye-catchers or to highlight content on whiteboards and other magnetic surfaces.</p>
<p>BA-014TR Magnetic symbols Triangle large for whiteboards & planning boards, write-on 25 symbols per A4 sheet in different colours Weight: 240 g/set</p>	<p>Price in EUR 1 set 4,53/set from 3 sets 3,94/set from 10 sets 3,42/set from 20 sets 3,16/set from 40 sets 2,94/set</p>	<p>Large magnetic triangle symbols made of colourful magnetic sheets serve as eye-catchers or to highlight content on whiteboards and other magnetic surfaces.</p>
<p>BA-014RE Magnetic symbols Rectangle large for whiteboards & planning boards, write-on 10 symbols per A4 sheet in different colours Weight: 240 g/set</p>	<p>Price in EUR 1 set 4,53/set from 3 sets 3,94/set from 10 sets 3,42/set from 20 sets 3,16/set from 40 sets 2,94/set</p>	<p>Large magnetic rectangle symbols made of colourful magnetic sheets serve as eye-catchers or to highlight content on whiteboards and other magnetic surfaces.</p>
<p>BA-012A Magnetic symbols Arrow small for whiteboards & planning boards 30 symbols per sheet in different colours Weight: 47 g</p>	<p>Price in EUR 1 pc. 6,89 ea.</p>	<p>Coloured small magnetic arrow symbols are eye-catchers and can be used to mark whiteboard content.</p>
<p>BA-012R Magnetic symbols Rectangle small for whiteboards & planning boards 56 symbols per sheet in different colours Weight: 47 g</p>	<p>Price in EUR 1 pc. 6,89 ea.</p>	<p>Coloured small magnetic rectangular symbols are eye-catchers and can be used for marking content on whiteboards and other magnetic surfaces.</p>
<p>BA-012S Magnetic symbols Square small for whiteboards & planning boards 112 symbols per sheet in different colours Weight: 47 g</p>	<p>Price in EUR 1 pc. 6,89 ea.</p>	<p>Coloured magnetic squares are eye-catchers and can be used for marking content on whiteboards and other magnetic surfaces.</p>
<p>BA-012T Magnetic symbols Triangle small for whiteboards & planning boards 180 symbols per sheet in different colours Weight: 47 g</p>	<p>Price in EUR 1 pc. 6,89 ea.</p>	<p>Coloured small magnetic triangles are eye-catchers and can be used for marking content on whiteboards and other magnetic surfaces.</p>
<p>BA-012C Magnetic symbols Circle small for whiteboards & planning boards 50 symbols per sheet in different colours Weight: 47 g</p>	<p>Price in EUR 1 pc. 6,89 ea.</p>	<p>Coloured small magnetic circle symbols are eye-catchers and can be used for marking content on whiteboards and other magnetic surfaces.</p>

BA-007 Chalk white for writing on wall boards set of 12 Weight: 11 g/set	Price in EUR 1 set 4,99/set	White chalkboard chalk by Pelican, 12-pack. The chalk is dust-free and has a strong colour flow.
BA-008 Chalk set multicoloured for writing on wall boards set of 12 Weight: 13 g/set	Price in EUR 1 set 9,99/set	Blackboard chalk set by Pelican, dust-free, in 12 beautiful colours. The intense chalk colours make drawings and writings on the wall chalkboard stand out.
BA-009 Holder for whiteboard markers magnetic for 4 markers markers not included in delivery Weight: 100 g	Price in EUR 1 pc. 12,97 ea.	Discreet magnetic holder for storing 4 whiteboard or flip chart markers directly on the whiteboard. Delivery without markers.
BA-019 Whiteboard marker black with magnetic wiper Weight: 39 g	Price in EUR 1 pc. 3,99 ea.	Black whiteboard marker S by MAUL with magnetic board wiper (50 mm diameter) that also holds markers. Works on whiteboards, glass, and other smooth and writeable surfaces.
BA-010A Whiteboard wiper magnetic high absorbing power exchangeable fleece Weight: 88 g	Price in EUR 1 pc. 8,57 ea.	A modern and ergonomic dry eraser with thick and special fleece. The fleece features a high absorbing capacity and economical use. Once it is all used up, we have the fitting refill fleece in our assortment.
BA-018 Whiteboard marker set of 4 assorted colours Weight: 71 g/set	Price in EUR 1 set 5,99/set	Whiteboard marker in a set of 4. Suitable for whiteboards, glass, and other smooth and writeable surfaces. You will receive the following colours: black, blue, red, green
BA-010B Refill fleece for whiteboard wiper set of 10 Weight: 20 g/set	Price in EUR 1 set 4,76/set	Thick and special fleece for magnetic dry eraser BA-010A. The fleece features economic use and high absorbing capacity. Made in Germany.

Magnetic hooks & magnetic clips

Coloured and original magnetic hooks and magnetic clips are perfect for use in the office, kitchen or bathroom. They can hold light objects, such as hand towels, kitchen utensils, scissors, key rings, etc. securely on the fridge or on the magnetic board. Thanks to their attractive packaging, they also make for a practical and affordable gift.

<p>M-90 Magnetic hook with rotating double hook plasticised extra strong adhesive force approx. 18 kg Weight: 200 g strength: approx. 18 kg</p>	<p>Price in EUR 1 pc. 9,88 ea.</p>	<p>Not your typical magnetic hook: Features not just one but two hooks in different lengths, which can be turned as needed.</p>
<p>M-96 Magnetic hook with revolving hook plasticised extra strong Adhesive force approx. 10 kg Weight: 86 g strength: approx. 10 kg</p>	<p>Price in EUR 1 pc. 13,45 ea.</p>	<p>Sturdy magnetic hook made of black plastic with rotating hook. Strong holding power and improved hold thanks to rubberised backside.</p>
<p>LIV-101 Magnetic hook "Black Mamba" black with slip-resistant coating set of 2 Weight: 200 g/set</p>	<p>Price in EUR 1 set 14,99/set</p>	<p>2 simple black magnetic hooks can be used on many magnetic surfaces. With no-slip surface made of silicone.</p>
<p>LIV-137 Magnetic hook "White Mamba" white with slip-resistant coating set of 2 Weight: 200 g/set</p>	<p>Price in EUR 1 set 14,99/set</p>	<p>2 simple white magnetic hooks can be used on many magnetic surfaces. With no-slip surface made of silicone.</p>
<p>LIV-102 Magnetic hook "Porta" stainless steel with slip-resistant coating set of 2 Weight: 78 g/set strength: approx. 1 kg</p>	<p>Price in EUR 1 set 9,99/set</p>	<p>2 stainless steel magnetic hooks to be used on many magnetic surfaces. Thanks to the slip-resistant silicone surface the hooks can hold a lot without sliding down.</p>
<p>M-86 Letter clamp magnetic silver, made of metal set of 3 Weight: 200 g/set strength: approx. 4,5 kg</p>	<p>Price in EUR 1 set 21,30/set</p>	<p>Practical magnetic file clamps with many positive features: Clever, easy to grasp, sturdy, powerful, universal use. Ideal for storing or presenting letters, documents, files, instructions, and notes.</p>
<p>LIV-99 Magnetic clip "Kolor Klip" colourful clothes-peg magnets set of 6 Weight: 27 g/set strength: approx. 400 g</p>	<p>Price in EUR 1 set 10,99/set</p>	<p>Colourful mini wooden pegs with strong neodymium magnet on the backside.</p>
<p>LIV-100 Magnetic clips "Graffa" black metal set of 4 Weight: 60 g/set</p>	<p>Price in EUR 1 set 9,99/set</p>	<p>Small, discreet black metal clips with a strong magnet on the back.</p>

<p>LIV-161 Magnetic clips "Graffa" silver-blue metal set of 4 Weight: 60 g/set</p>	<p>Price in EUR 1 set 9,99/set</p>	<p>Small silver-blue metal clips with a strong magnet on the back.</p>
<p>LIV-113 Magnetic clips "Graffa" transparent made of plastic set of 4 Weight: 42 g/set</p>	<p>Price in EUR 1 set 9,99/set</p>	<p>Small, discreet clip made of transparent plastic with a strong magnet on the backside.</p>
<p>LIV-112 Magnetic clips "Graffa" XXL with very high adhesive force set of 2 Weight: 120 g/set</p>	<p>Price in EUR 1 set 14,99/set</p>	<p>Extra large and strong magnetic clips in a set of 2 with strong neodymium magnet and anti-skid coating.</p>
<p>LIV-79 Magnetic clips "Graffa" XL with very high adhesive force set of 2 Weight: 70 g/set</p>	<p>Price in EUR 1 set 11,99/set</p>	<p>Two strong magnetic clips that adhere to any metal surface. You can attach calendars, recipes or magazines to always have them handy. Thanks to the non-slip coating, these clips stay in place even with heavy objects on them.</p>
<p>LIV-17 Magnetic clip "Clipper" chrome-plated set of 4 Weight: 33 g/set strength: approx. 300 g</p>	<p>Price in EUR 1 set 10,99/set</p>	<p>The chrome-plated eye catcher for the office - or the laundry room ;-). It holds several notes, single pictures or even a small brochure on a magnetic board. Chrome-plated surface, set of 4. Each clip is 2,5 cm x 1 cm.</p>
<p>LIV-61 Magnetic hook "Solid" classy magnetic hooks set of 4 Weight: 79 g/set strength: approx. 2,6 kg</p>	<p>Price in EUR 1 set 14,99/set</p>	<p>Classy, discreet magnetic hooks can be used on any magnetic surface: Whiteboard, magnetic board, steel cabinet, etc. Thanks to the slip-resistant silicone surface, the hooks can hold even heavy objects without slipping off.</p>
<p>LIV-70 Magnetic hook "Azulejos" magnetic hooks with tile pattern set of 2 Weight: 140 g/set strength: approx. 5,5 kg</p>	<p>Price in EUR 1 set 16,99/set</p>	<p>The pattern of these strong magnetic hooks is based on Portuguese tiles. The hooks beautify any metal surface and can easily hold several hand towels or even a jacket.</p>
<p>LIV-71 Magnetic hook "Retro" strong magnetic hooks set of 2 Weight: 140 g/set strength: approx. 5,5 kg</p>	<p>Price in EUR 1 set 16,99/set</p>	<p>Two strong hook magnets in trendy retro style! You can use them to hang up hand towels or kitchen utensils on metal surfaces.</p>
<p>LIV-122 Colourful magnet clips made of ferrite set of 6 Weight: 280 g/set</p>	<p>Price in EUR 1 set 9,99/set</p>	<p>Colourful magnet clips for home, office, storage, school, or workshop. Set of 6 contains magnet clips in different colours.</p>

Home design & (magnetic) home accessories

Here you can find decorative articles that will beautify your home or office: Colourful magnetic note pads, pencils, bottle opener, hand towel holder, etc. Some articles are not magnetic, which we reference in the product description.

<p>LIV-147 Trivet Van magnetic made of silicone heat-resistant up to 250 °C Weight: 130 g</p>	<p>Price in EUR 1 pc. 11,85 ea.</p>	<p>Magnetic silicone trivet in the shape of an old VW bus. The gadget for all VW bus enthusiasts!</p>
<p>LIV-148 Trivet Scooter magnetic made of silicone heat-resistant up to 250 °C Weight: 100 g</p>	<p>Price in EUR 1 pc. 11,85 ea.</p>	<p>The trivet in the shape of a red scooter measures 18 x 12,5 x 0,7 and withstands temperatures of up to 250 °C.</p>
<p>LIV-149 Trivet Cow magnetic made of silicone heat-resistant up to 250 °C Weight: 84 g</p>	<p>Price in EUR 1 pc. 11,85 ea.</p>	<p>The trivet in the shape of a black and white cow measures 18,7 x 16,5 x 0,5 and withstands temperatures of up to 250 °C.</p>
<p>M-SOAP-1 Soap holder magnetic with a suction cup and stainless steel disc to attach in the sink Weight: 17 g strength: approx. 120 g</p>	<p>Price in EUR 1 pc. 9,80 ea.</p>	<p>Magnetic soap holder for securing solid soap (up to 120 g) to the sink. The soap dries easily after use thanks to its attachment with suction cup and metal plate.</p>
<p>NGP-05 silwy Metal-Nano-Gel-Pads Ø 5,0 cm self-adhering surface for magnets reusable, with synthetic leather coating set of 4, in different colours Weight: 54 g/set</p>	<p>Price in EUR 1 set 12,95/set</p>	<p>The metal-nano-gel-pads by silwy adhere to almost any surface, can be removed without leaving any residue and are reusable any number of times.</p>
<p>NGP-06 silwy Metal-Nano-Gel-Pads Ø 6,5 cm self-adhering surface for magnets reusable, with synthetic leather coating set of 4, in different colours Weight: 80 g/set</p>	<p>Price in EUR 1 set 16,95/set</p>	<p>The perfect accessory for caravans, campers, campervans, boats, yachts, sailing boats or your home.</p>
<p>NGP-CR silwy Metal-Nano-Gel-Pad Ø 6,5 cm with hook magnet "Clever" self-adhering surface for magnets reusable, with synthetic leather coating set, in different colours Weight: 67 g/set</p>	<p>Price in EUR 1 set 12,95/set</p>	<p>Mounting a hook without drilling? The German brand silwy makes it possible with their metal-nano-gel-pad and a white hook magnet. One set contains one pad and one hook magnet.</p>
<p>NGP-FX silwy Metal-Nano-Gel-Pads Ø 5,0 cm with magnetic pins "Flex" self-adhering surface for magnets reusable, with synthetic leather coating set of 4, in different colours Weight: 94 g/set</p>	<p>Price in EUR 1 set 24,95/set</p>	<p>A strong team: metal-nano-gel-pads by silwy & black magnetic pins. One pin on one pad can hold approx. 10 sheets of paper with a total weight of 80 g.</p>

<p>NGP-OE silwy Metal-Nano-Gel-Pad Ø 6,5 cm with rotating hook magnet "The One" self-adhering surface for magnets reusable, with synthetic leather coating set, in different colours Weight: 130 g/set</p>	<p>Price in EUR 1 set 16,95/set</p>	<p>With the help of this set you can quickly create a space to hang lightweight objects of up to 0,5 kg. Set contains a gel pad and rotating hook magnet.</p>
<p>NGP-OV silwy Metal-Nano-Gel-Coasters self-adhering surface for magnets reusable, with synthetic leather coating set of 2, in different colours Weight: 69 g/set</p>	<p>Price in EUR 1 set 14,95/set</p>	<p>These metal-nano-gel-coasters are not only perfect for the magnetic glasses by silwy (available from our shop in spring 2021), but they are also a great surface for attaching our magnets.</p>
<p>NGP-ST silwy Metal-Nano-Gel-Pads Ø 5,0 cm with magnets "Smart" self-adhering surface for magnets reusable, with synthetic leather coating set of 2, in different colours Weight: 130 g/set</p>	<p>Price in EUR 1 set 18,95/set</p>	<p>Thanks to the metal-nano-gel-pads by silwy, you can create an area for attaching magnets on almost any surface. One set contains 2 pads and 2 stylish magnets. One magnet on the pad holds approx. 20 sheets of paper with a total weight of 80 g.</p>
<p>M-BOOK Bookends magnetic metal set of 2 in different colours Weight: 510 g/set</p>	<p>Price in EUR 1 set 11,31/set</p>	<p>Thanks to the strong magnetic area on the bottom side, they securely stay in place on steel shelves and provide the wanted stability. Available in three colours.</p>
<p>M-84 Bookends with animal design powder-coated steel, set of 2 not magnetic! Weight: 720 g/set</p>	<p>Price in EUR 1 set 19,99/set</p>	<p>Not just for bookworms: Cute bookends with animal designs that should be on every bookshelf.</p>
<p>SALE-114 Metal hooks self-adhesive square, white set of 4 not magnets! Weight: 52 g/set</p>	<p>Price in EUR 1 set 3,90/set</p>	<p>Elegant white metal hooks with strong 3M adhesive on the backside adhere securely to smooth surfaces. You receive four square white hooks.</p>
<p>SALE-115 Metal hooks self-adhesive round, blue set of 4 not magnets! Weight: 52 g/set</p>	<p>Price in EUR 1 set 3,90/set</p>	<p>Elegant round metal hooks with strong 3M adhesive on the backside adhere securely to smooth surfaces. You receive four round blue hooks.</p>
<p>M-53 Tower of Power decorative haematite hexamerous Weight: 310 g/set</p>	<p>Price in EUR 1 set 14,99/set</p>	<p>The cube set made of hematite is a true gem for any desk. It impresses with its plain aesthetics and variety. But the Tower of Power fulfills also practical needs and makes for a great paper weight or original note holder.</p>
<p>M-64 Suction cup card holder with crocodile clip not magnetic! Weight: 10 g</p>	<p>Price in EUR 1 pc. 4,98 ea.</p>	<p>This suction cup card holder can be attached to all sorts of surfaces where magnets don't work. The crocodile clip holds postcards and photos.</p>

<p>M-73 Tea infuser Iceberg silicone tea infuser non-magnetic! Weight: 54 g</p>	<p>Price in EUR 1 pc. 7,99 ea.</p>	<p>Funny tea infuser in the shape of a polar bear family on an iceberg. Material: Silicone</p>
<p>M-39 Beer tree small magnetic beer cap collector ideal party gift holds up to 70 bottle caps Weight: 97 g</p>	<p>Price in EUR 1 pc. 19,95 ea.</p>	<p>For the beer tree you don't need a green thumb, you just need to be thirsty, because with every bottled beer your tree will grow a little bit. The strong magnet on the top of the tree trunk can easily hold 50 bottle caps, if you work on it even up to 70. The more you add, the more impressive the treetop will be.</p>
<p>M-47 Beer tree large magnetic beer cap collector ideal party gift holds up to 120 bottle caps Weight: 150 g</p>	<p>Price in EUR 1 pc. 35,99 ea.</p>	<p>For the beer tree you don't need a green thumb, you just need to be thirsty, because with every bottled beer your tree will grow a little bit. The strong magnet on the top of the tree trunk can easily hold 120 bottle caps.</p>
<p>M-91 Magnetic bottle opener "Captor" attaches to the fridge with bottle cap collector on the front Weight: 470 g</p>	<p>Price in EUR 1 pc. 29,00 ea.</p>	<p>Cast iron bottle opener for the wall collects up to 50 bottle caps thanks to the strong neodymium magnet on the front. Can be mounted to nearly all metal surfaces with the four rubberised neodymium magnets on the backside.</p>
<p>M-40 Wall bottle opener beer bottle opener with magnetic bottle cap collector incl. mounting accessories Weight: 470 g/set</p>	<p>Price in EUR 1 set 29,90/set</p>	<p>This magnetic bottle opener not only attracts everyone's attention - it also catches the falling bottle caps. It can collect up to 60 caps that form a cluster underneath the opener.</p>
<p>LIV-106 Magnetic bottle opener attaches to a fridge or the like set of 2 Weight: 71 g/set</p>	<p>Price in EUR 1 set 4,99/set</p>	<p>Colourful, handy bottle opener with beer designs and magnet on the backside.</p>
<p>LIV-76 Magnetic bottle opener 'Ocean' attaches to the fridge set of 2 in second-hand look Weight: 250 g/set</p>	<p>Price in EUR 1 set 9,99/set</p>	<p>These nautical bottle openers bring a fresh breeze into your kitchen! You can attach them to the fridge or a metal cabinet and have them always handy.</p>
<p>M-43 Wooden blocks set 27 magnetic wooden cubes made of oiled oak wood Weight: 510 g/set</p>	<p>Price in EUR 1 set 64,99/set</p>	<p>Thanks to the embedded sphere magnets, the 27 wooden cubes are magnetic on all six sides, which allows for building various imaginative constructs.</p>
<p>M-41 Tangram cube made of 24 magnetic tetrahedrons with 20 templates Weight: 590 g</p>	<p>Price in EUR 1 pc. 27,47 ea.</p>	<p>You need all your wits for this game! The Tangram cube consists of 24 magnetic plastic pyramids. With these tetrahedrons you can also build more challenging shapes and figures.</p>

M-46 Mounting set for smoke alarm equipped with neodymium magnets Weight: 39 g	Price in EUR 1 pc. 3,99 ea. from 3 pcs. 3,80 ea. from 10 pcs. 3,64 ea.	Our mounting set allows for quick and easy mounting of a smoke detector: Strong magnets hold the smoke detector on the ceiling.
LIV-33 Magnetic vase Maple vase made of maple wood magnetic on metal plate gift-wrapped Weight: 78 g	Price in EUR 1 pc. 19,99 ea.	This delicate maple vase stands out with its simple elegance and clever functionality.
LIV-34 Magnetic vase Oak vase made of oak wood magnetic on metal plate gift-wrapped Weight: 88 g	Price in EUR 1 pc. 19,99 ea.	This delicate oak vase stands out with its simple elegance and clever functionality.
MON-01 Monolux magnetic candle holder in a gift box Weight: 100 g	Price in EUR 1 pc. 24,99 ea.	The Monolux always finds a place - wherever you wish for cosiness. It stays wherever there is a magnetic surface! On the fridge, on a shelf, on the stair railing and even on a pin...
LIV-78 Christmas tree ball ornaments "Black Magic" with white marker for labelling set of 2 not magnetic! Weight: 85 g/set	Price in EUR 1 set 12,00/set	With our Christmas tree ball ornament labelling set you can make your very individual Christmas decoration. The matt-black glass ornaments are writable with chalk marker. Mistakes can be removed with the included magic sponge and a little bit of water.

Metal strips: decorative surfaces for magnets

<p>M-FERROTAPE Metal tape self-adhesive white 35 mm self-adhesive surface for magnets rolls of 1 m / 5 m / 25 m Weight: 75 g/m</p>	<p>Price in EUR 1 m 5,59/m from 5 m 3,86/m from 25 m 2,81/m</p>	<p>Metal tape with self-adhesive cushioning on the back. The strip can be cut with normal scissors to the desired length, since it is only 0,15 mm thick. It also adheres to textured walls and is easy to install around corners.</p>
<p>NGP-MB-25 silwy metal strip self-adhesive 25 cm self-adhesive surface for magnets with synthetic leather cover in different colours Weight: 540 g</p>	<p>Price in EUR 1 pc. 24,95 ea.</p>	<p>The metal strip with 3M adhesive film is ideal as a decorative adhesive surface for magnets. A perfect accessory for caravans, campers, boats, yachts, sailing boats or your home.</p>
<p>NGP-MB-50 silwy metal strip self-adhesive 50 cm self-adhesive surface for magnets with synthetic leather cover in different colours Weight: 540 g</p>	<p>Price in EUR 1 pc. 29,95 ea.</p>	<p>Length: 50 cm Width: 5 cm Thickness: 3 mm Material: premium synthetic leather Brand: silwy Made in: Germany</p>
<p>MB-18 Metal strip self-adhesive 50 cm self-adhesive surface for magnets metal in different colours Weight: 160 g</p>	<p>Price in EUR 1 pc. 4,89 ea. from 3 pcs. 4,47 ea. from 10 pcs. 4,09 ea. from 40 pcs. 3,73 ea. from 80 pcs. 3,57 ea.</p>	<p>This narrow metal strip is an ideal surface for small magnets. It is great for attaching postcards, event flyers, photos, business cards, children's drawings, posters, etc. with magnets.</p>
<p>MB-19 Metal strip self-adhesive 80 cm self-adhesive surface for magnets metal in different colours Weight: 260 g</p>	<p>Price in EUR 1 pc. 7,32 ea. from 3 pcs. 6,73 ea. from 10 pcs. 6,19 ea. from 40 pcs. 5,69 ea. from 80 pcs. 5,47 ea.</p>	<p>This narrow self-adhesive metal strip (80 cm) is the perfect surface for small magnets. Use it to hang notes, photos, drawings, posters, etc.</p>
<p>MB-17 Metal strip "Element Big" 70 cm surface for magnets, to screw on incl. 12 strong magnets in different colours Weight: 310 g</p>	<p>Price in EUR 1 pc. 23,47 ea.</p>	<p>This 70 cm long magnetic strip made of steel sheet can easily be screwed onto the wall with two screws. The included 12 small magnets can hold photos, shopping lists, etc.</p>
<p>MB-16 Metal strip "Element Small" 35 cm surface for magnets, to screw on incl. 6 strong magnets in different colours Weight: 130 g</p>	<p>Price in EUR 1 pc. 14,03 ea.</p>	<p>This discreet metal strip is made of steel sheet and is easily wall-mounted with two screws. The included 6 small magnets can hold photos, shopping lists, etc.</p>
<p>FO-5 Metal strips stainless steel 50 cm, set of 2 surface for magnets with magnetic mounting incl. 12 strong magnets Weight: 490 g/set</p>	<p>Price in EUR 1 set 20,00/set</p>	<p>Two metal strips made of 1,5 mm thick stainless steel, polished on one side and brushed on the other. Includes 12 disc magnets.</p>

<p>MB-01 Metal strip "Mikado" black 80 cm surface for magnets with magnetic mounting incl. 10 strong magnets Weight: 270 g</p>	<p>Price in EUR 1 pc. 33,62 ea.</p>	<p>Steel sheet ledge including 10 magnets. This simple steel sheet ledge is attached to the wall with two bigger magnets. You can attach photos, shopping list, etc. with the enclosed 10 small magnets.</p>
<p>MB-02 Metal strip "Mikado" grey 80 cm surface for magnets with magnetic mounting incl. 10 strong magnets Weight: 270 g</p>	<p>Price in EUR 1 pc. 33,62 ea.</p>	<p>Steel sheet ledge including 10 magnets. This simple steel sheet ledge is attached to the wall with two bigger magnets. You can attach photos, shopping list, etc. with the enclosed 10 small magnets.</p>
<p>MB-04 Metal strip "Mikado" white 80 cm surface for magnets with magnetic mounting incl. 10 strong magnets Weight: 270 g</p>	<p>Price in EUR 1 pc. 33,62 ea.</p>	<p>Steel sheet ledge including 10 magnets. This simple steel sheet ledge is attached to the wall with two bigger magnets. You can attach photos, shopping list, etc. with the enclosed 10 small magnets.</p>

Ferrous strips & metal strips

FT-1005	Ferrous tape self-adhesive 5 m x 10 mm self-adhesive surface for magnets rolls of 5 m each in different colours Weight: 180 g	Price in EUR	1 pc. 4,79 ea. from 3 pcs. 4,10 ea. from 10 pcs. 3,48 ea. from 20 pcs. 3,19 ea. from 40 pcs. 2,92 ea.	Ferrous tape is a thin plastic strip containing iron particles. Large pot magnets and neodymium magnets are not suitable for use on ferrous strips, due to their considerable weight.
FT-1025	Ferrous tape self-adhesive 25 m x 10 mm self-adhesive surface for magnets rolls of 25 m each in different colours Weight: 910 g	Price in EUR	1 pc. 18,77 ea. from 3 pcs. 16,17 ea. from 10 pcs. 13,84 ea. from 20 pcs. 12,71 ea.	This self-adhesive ferrous strip is an ideal surface for magnets. You can easily cut the ferrous tape to size using household scissors or a cutter.
FT-2005	Ferrous tape self-adhesive 5 m x 20 mm self-adhesive surface for magnets rolls of 5 m each in different colours Weight: 370 g	Price in EUR	1 pc. 8,63 ea. from 3 pcs. 7,38 ea. from 10 pcs. 6,26 ea. from 20 pcs. 5,71 ea. from 40 pcs. 5,23 ea.	Create order in your everyday life with self-adhesive ferrous tape. The flexible strip lets you create a suitable surface for magnets in no time.
FT-2025	Ferrous tape self-adhesive 25 m x 20 mm self-adhesive surface for magnets rolls of 25 m each in different colours Weight: 1,8 kg	Price in EUR	1 pc. 33,59 ea. from 3 pcs. 28,92 ea. from 10 pcs. 24,75 ea.	Mounting a ferrous strip is very simple: Remove the protective film from the self-adhesive backing and press the ferrous tape firmly onto the desired surface. No need for drilling any holes.

Magnetic closures for jewellery, bags, shoes and furniture

Jewellery, shoes or hand-sewn purses - a magnetic clasp is the right solution for easy closing and opening. The two parts find each other all by themselves. Once closed, the strong magnets ensure a secure hold. To open them you simply shift them sideways or in opposite directions.

<p>CLA-14 Magnetic closure bag small magnetic buttons 4-piece set for leather, fabric and other textiles Weight: 3,5 g strength: approx. 1,5 kg</p>	<p>Price in EUR 10 pcs. 0,56 ea. from 40 pcs. 0,47 ea. from 80 pcs. 0,43 ea. from 160 pcs. 0,39 ea.</p>	<p>The perfect closure for your handmade bags! Suitable for fastening leather or thick material. You will receive 4 pieces: 1 clamp (Magnet) with recess, 1 clamp (counterpiece) with knob, 2 reinforcement discs.</p>
<p>CLA-18 Magnetic closure bag large magnetic buttons 4-piece for leather, fabric and other textiles Weight: 5,5 g strength: approx. 2,5 kg</p>	<p>Price in EUR 5 pcs. 0,73 ea. from 15 pcs. 0,64 ea. from 40 pcs. 0,57 ea. from 80 pcs. 0,52 ea.</p>	<p>The perfect closure for your handmade bags! Suitable for fastening leather or thick material. You will receive 4 pieces: 1 clamp (Magnet) with recess, 1 clamp (counterpiece) with knob, 2 reinforcement discs</p>
<p>SV-ES-08 Jewellery clasp magnetic round small for necklaces / bracelets Ø 8 mm Weight: 1 g</p>	<p>Price in EUR 1 pc. 5,90 ea. from 3 pcs. 5,40 ea. from 10 pcs. 4,95 ea. from 20 pcs. 4,75 ea. from 40 pcs. 4,55 ea.</p>	<p>This discreet, spherical magnetic jewellery clasp is perfect for thin necklaces and bracelets of all sorts. Two strong magnets are glued into the plastic clasp and safely hold your jewellery together.</p>
<p>SV-ES-15 Jewellery clasp magnetic round large for necklaces / bracelets Ø 15 mm Weight: 3,5 g</p>	<p>Price in EUR 1 pc. 8,90 ea. from 3 pcs. 8,15 ea. from 10 pcs. 7,45 ea. from 20 pcs. 7,10 ea. from 40 pcs. 6,80 ea.</p>	<p>This ball-shaped magnetic jewellery clasp is perfect for necklaces and bracelets. Two extremely strong magnets are glued into the plastic clasps and guarantee that the jewellery stays together safely.</p>
<p>SV-FP-01 Jewellery clasp magnetic with pattern for bracelets extra-strong hold Weight: 8 g</p>	<p>Price in EUR 1 pc. 8,90 ea. from 3 pcs. 8,10 ea. from 10 pcs. 7,40 ea. from 20 pcs. 7,05 ea. from 40 pcs. 6,70 ea.</p>	<p>Strong jewellery clasp with neodymium magnets for flat bracelets (opening 10 x 2 mm). Nickel-free, lead-free and cadmium-free.</p>
<p>SV-K01 Jewellery clasp magnetic Celtic for bracelets rectangular Weight: 8 g</p>	<p>Price in EUR 1 pc. 8,90 ea. from 3 pcs. 8,10 ea. from 10 pcs. 7,40 ea. from 20 pcs. 7,05 ea. from 40 pcs. 6,70 ea.</p>	<p>Extra strong jewellery clasp with neodymium magnets for flat bracelets (opening 10 x 2 mm). Nickel-free, lead-free and cadmium-free.</p>
<p>M-ZUB-01 Zubits® S magnetic shoe closures for children & the elderly in different colours Weight: 31 g/set</p>	<p>Price in EUR 1 set 19,99/set</p>	<p>Magnetic shoe closure for quick in and out of shoes. Secure footing, even with heavy use.</p>
<p>M-ZUB-02 Zubits® M magnetic shoe closures for youth & adults in different colours Weight: 40 g/set</p>	<p>Price in EUR 1 set 20,49/set</p>	<p>Magnetic shoe closures for quick in and out of shoes. Secure hold, even when active.</p>

M-ZUB-03

Zubits® L
magnetic shoe closures
for sports shoes & tall
people
in different colours
Weight: 45 g/set

Price in EUR Magnetic shoe closure for quick in and out of shoes.
1 set 20,99/set Secure footing, even with heavy use.

Sugru: Mouldable glue and multi-functional putty

Are you looking for an all-purpose helper for attachments and repairs? Then you need the wonder putty Sugru with 1001 application possibilities the right thing for you! It is a mouldable adhesive made of silicone rubber, which is very flexible and mouldable into various shapes. It adheres to many different materials and combines them permanently. It is also suitable for repairing holes, rips, cable breaks, and other damages. Since the adhesive putty is available in so many different colours, you can choose if you would like your repair in a low-key black, white, or grey or if you prefer bright colours that draw attention to the successful life hack.

SUG-08 Sugru Set of 8 mouldable glue in different colours packages of 5 g each Weight: 69 g/set	Price in EUR 1 set 15,99/set	Sugru is a mouldable glue. It feels like putty and is just as easy to use. Simply mould it by hand and put it in place, let it harden over night at room temperature, done! Set with 8 single-use packets.
SUG-03 Sugru set of 3 mouldable glue in different colours packages of 5 g each Weight: 30 g/set	Price in EUR 1 set 8,99/set	Sugru is a mouldable glue. It feels like putty and is just as easy to use. Simply mould it by hand and put it in place, let it harden over night at room temperature, done! Set with 3 single-use packets.
SUG-MK Sugru magnetic kit mouldable glue with 4 neodymium disc magnets in practical metal box Weight: 47 g/set	Price in EUR 1 set 15,00/set	The combination with strong neodymium magnets makes Sugru the miracle cure for every household. We offer this dream team now as a complete set: 3 packets Sugru and 4 flat disc magnets, packaged in a nice metal box.

Smart putty: Fun & play with magnetic putty & Co.

Smart Putty impresses with cool tricks and fascinating effects. You can shape it, knead it, pull it, rip it, or let it bounce. We carry many different types of this putty, each with unique features. The ferromagnetic putty is attracted by magnets, "Glow" glows in the dark, "Metallic" surprises with a metallic look.

<p>M-PUTTY-MINI Smart putty "Mini" in small tins different colours not magnetic! Weight: 29 g</p>	<p>Price in EUR 1 pc. 3,95 ea.</p>	<p>The minis are here! Many of the well-known and popular colours are now also available in small tins. New are bright neon colours that glow in the dark.</p>
<p>M-PUTTY-FERRO Smart putty magnetic ferromagnetic putty different colours magnet not included Weight: 140 g</p>	<p>Price in EUR 1 pc. 12,95 ea.</p>	<p>The magnetic smart putty impresses with cool tricks and fascinating effects. As soon as a super magnet is nearby, the smart putty seems to come to life. Available in many colours.</p>
<p>M-PUTTY-GLOW Smart putty Glow glows in the dark different colours not magnetic! Weight: 140 g</p>	<p>Price in EUR 1 pc. 12,95 ea.</p>	<p>Smart putty impresses with cool tricks and fascinating effects. The model "Glow" even glows in the dark.</p>
<p>M-PUTTY-CAMO Smart putty Camo changes colour during kneading different colours not magnetic! Weight: 140 g</p>	<p>Price in EUR 1 pc. 12,95 ea.</p>	<p>Smart putty impresses with cool tricks and fascinating effects. The model "Camo" even changes colour.</p>
<p>M-PUTTY-IRIS Smart putty Flip Flop shimmers in various colours not magnetic! Weight: 140 g</p>	<p>Price in EUR 1 pc. 13,95 ea.</p>	<p>Smart putty impresses with cool tricks and fascinating effects. The model "Flip Flop" also shimmers in the most beautiful colours.</p>
<p>M-PUTTY-GLASS Smart putty "Crystal Clear" transparent not magnetic! Weight: 140 g</p>	<p>Price in EUR 1 pc. 12,95 ea.</p>	<p>What? An empty can? No, this smart putty is transparent and looks like liquefied glass!</p>
<p>M-PUTTY-GLITTER Smart putty Glitter with glitter different colours not magnetic! Weight: 140 g</p>	<p>Price in EUR 1 pc. 12,95 ea.</p>	<p>Smart putty impresses with cool tricks and fascinating effects. Additional feature of the "Glitter" type: It shimmers as if millions of stars were trapped inside!</p>
<p>M-PUTTY-METALLIC Smart putty Metallic metallic sparkling different colours not magnetic! Weight: 140 g</p>	<p>Price in EUR 1 pc. 12,95 ea.</p>	<p>Smart putty impresses with cool tricks and fascinating effects. Additional feature of the "Metallic" type: It looks like molten metal that melts in your hand!</p>

Magnetic toys

Our colourful magnetic toys with their different shapes offer long-lasting fun at playtime. With a little imagination the magnetic elements can be put together again and again to form new objects and configurations. That's not only fun for kids but also for grown-ups. We, here at supermagnete, are perfect proof of that!
Our tip: Magnetic toys are a great gift for children to introduce them to magnetism through play.

TG-CUBE-01 Magic cube 3x3 speed cube magnetic WeiLong GTS2M by MoYu Weight: 88 g	Price in EUR 1 pc. 29,99 ea.	The WeiLong GTS2M by MoYu features integrated magnets which have an extremely positive effect on the solving accuracy.
TG-CUBE-02 Magic cube 4x4 speed cube magnetic WuQue Mini M by QiYi Weight: 140 g	Price in EUR 1 pc. 34,99 ea.	The WuQue Mini M by QiYi is a 4x4 magic cube. Magnets on the inside provide better accuracy when solving the puzzle.
TG-CUBE-03 Magic pyramid Pyraminx speed cube magnetic Bell Pyraminx by QiYi Weight: 110 g	Price in EUR 1 pc. 12,99 ea.	Bell Pyraminx magic pyramid with magnets inside. You can place these magnets as needed.
TG-CUBE-04 Magic cube Skewb speed cube magnetic Wingy Skewb by QiYi Weight: 100 g	Price in EUR 1 pc. 14,99 ea.	Wingy Skewb magic cube with slightly concave sides. There are 24 small magnets on the inside, making it easier to position the individual parts.

Furniture magnets

<p>M-DOOR-01 Door stop magnetic to hold doors open Weight: 63 g strength: approx. 10 kg</p>	<p>Price in EUR</p> <p>1 pc. 12,99 ea. from 3 pcs. 11,92 ea. from 10 pcs. 10,97 ea. from 20 pcs. 10,51 ea. from 40 pcs. 10,10 ea.</p>	<p>The magnetic door stopper is great for keeping wooden doors open. It can be embedded in the bottom of the door or screwed into the back of the door.</p>
<p>M-DOOR-02 Plastic casing for door stop M-DOOR-01 to screw to the side of the door Weight: 10 g</p>	<p>Price in EUR</p> <p>1 pc. 4,93 ea. from 3 pcs. 4,45 ea. from 10 pcs. 4,03 ea. from 20 pcs. 3,82 ea. from 40 pcs. 3,64 ea.</p>	<p>Length: 65 mm Width: 29 mm Height: 36 mm</p>
<p>M-DOOR-03 Mounting set for door stops metal disc with counterbore to screw into the floor or wall Weight: 30 g/set</p>	<p>Price in EUR</p> <p>1 set 3,21/set from 3 sets 2,88/set from 10 sets 2,57/set from 20 sets 2,43/set from 40 sets 2,30/set</p>	<p>Diameter: 45 mm Thickness: 2 mm</p>
<p>M-DOOR-04 Door stop magnetic with round pole areas adhesive angle of 280° Weight: 71 g strength: approx. 15 kg</p>	<p>Price in EUR</p> <p>1 pc. 9,97 ea. from 3 pcs. 9,19 ea. from 10 pcs. 8,49 ea. from 20 pcs. 8,15 ea. from 40 pcs. 7,85 ea.</p>	<p>Length: 60 mm Length 2: 16 mm Width: 25 mm Width 2: 15,5 mm Diameter: 9 mm Diameter 2: 5,5 mm</p>
<p>M-DOOR-05 Door stop magnetic with rubber buffer made of plastic, black Weight: 22 g strength: approx. 6 kg</p>	<p>Price in EUR</p> <p>1 pc. 7,73 ea. from 3 pcs. 7,04 ea. from 10 pcs. 6,43 ea. from 20 pcs. 6,13 ea. from 40 pcs. 5,87 ea.</p>	<p>Length: 65 mm Length 2: 50 mm Width: 30 mm Height: 23 mm Diameter: 22 mm Diameter 2: 5 mm</p>
<p>M-FURN-01 Magnetic fitting round for furniture set of magnet & metal plate to screw on Weight: 13 g/set strength: approx. 600 g</p>	<p>Price in EUR</p> <p>1 set 3,16/set from 3 sets 2,83/set from 10 sets 2,53/set from 20 sets 2,38/set from 40 sets 2,25/set</p>	<p>Diameter: 12 mm Height: 2 mm Total height: 12,5 mm</p>
<p>M-FURN-02 Magnetic fitting oval for furniture set of magnets & metal discs to screw on Weight: 10 g/set strength: approx. 1 kg</p>	<p>Price in EUR</p> <p>1 set 2,98/set from 3 sets 2,66/set from 10 sets 2,37/set from 20 sets 2,24/set from 40 sets 2,11/set</p>	<p>Length: 20 mm Width: 10 mm Height: 2 mm Total height: 5,5 mm</p>
<p>M-FURN-03 Magnetic fitting narrow for furniture metal with counterpart Weight: 30 g strength: approx. 2,5 kg</p>	<p>Price in EUR</p> <p>1 pc. 8,69 ea. from 3 pcs. 7,95 ea. from 10 pcs. 7,28 ea. from 100 pcs. 6,67 ea. from 500 pcs. 6,35 ea.</p>	<p>Narrow metal fitting with counterpart plate that can be used if needed. Fitting made of powder-coated metal, adhering surface rubberised.</p>

M-FURN-04

Magnetic fitting wide for
furniture
metal
with counterpart
Weight: 55 g
strength: approx. 2,5 kg

Price in EUR

	1 pc.	9,51 ea.
from	3 pcs.	8,69 ea.
from	10 pcs.	7,96 ea.
from	100 pcs.	7,29 ea.
from	500 pcs.	6,88 ea.

Wide metal fitting with long holes. Includes counterpart
plate that can be used if needed. Fitting made of powder-
coated metal, adhering surface rubberised.

Practical (magnet) products for the workshop

For tradespeople or DIY types - magnets are a big help in the workshop. You can comfortably pick up metal pieces with a telescope magnet. A bit holder ensures that you have accessories handy and a nail holder or welding aid helps you get done quicker. Our versatile assortment offers you useful products, such as an adhesive for magnets, a suitcase to store magnets, or the wonder putty Sugru.

<p>WS-MTH-01 Tool rack magnetic 35 cm magnetic strip screw-on tool holder Weight: 480 g</p>	<p>Price in EUR 1 pc. 9,90 ea. from 3 pcs. 8,52 ea. from 10 pcs. 7,28 ea.</p>	<p>This magnetic strip for tools measures 34,5 cm and can be fastened with four screws.</p>
<p>WS-MTH-02 Tool rack magnetic 51 cm magnetic strip screw-on tool holder Weight: 730 g</p>	<p>Price in EUR 1 pc. 15,91 ea. from 3 pcs. 13,64 ea. from 10 pcs. 11,61 ea.</p>	<p>This magnetic strip for tools measures 51 cm and can be fastened with four screws.</p>
<p>WS-MTH-03 Tool rack magnetic with handle magnetic strip tool holder with magnetic backside Weight: 590 g</p>	<p>Price in EUR 1 pc. 17,90 ea. from 3 pcs. 15,47 ea. from 10 pcs. 13,29 ea.</p>	<p>This magnetic strip for tools features a magnetic backside, so it can be securely attached to metal cupboards or drawers. Thanks to the handle you can easily remove it and put it wherever you need it.</p>
<p>WS-MWH-02 Wristband with magnet for nails, screws, bits, etc. Weight: 150 g</p>	<p>Price in EUR 1 pc. 5,36 ea. from 3 pcs. 4,63 ea. from 10 pcs. 3,97 ea.</p>	<p>Keeping screws and bits handy! With the wrist master you have metal parts close at hand - literally!</p>
<p>WS-ADH-01 UHU MAX REPAIR magnet glue waterproof, without solvents 20 g tube Weight: 20 g</p>	<p>Price in EUR 1 pc. 7,95 ea. (39,75/100 g)</p>	<p>Do you need a reliable adhesive for your super magnet application? We can recommend this adhesive with conviction. Suitable to use on wood, fabric, leather, cork, metal, glass, plastic, rubber, ceramic, stone or cement.</p>
<p>WS-PUT-01 Telescope magnet lifter small pick up tool 125 mm - 635 mm Weight: 35 g strength: approx. 800 g</p>	<p>Price in EUR 1 pc. 2,78 ea. from 3 pcs. 2,46 ea. from 10 pcs. 2,17 ea.</p>	<p>A small telescope magnet picker upper in practical pen format for picking up metal parts safely.</p>
<p>WS-PUT-02 Telescope magnet lifter large pick up tool 168 mm - 855 mm Weight: 90 g strength: approx. 2,5 kg</p>	<p>Price in EUR 1 pc. 5,17 ea. from 3 pcs. 4,57 ea. from 10 pcs. 4,03 ea.</p>	<p>Magnetic telescope tool for easy pick-up of metal parts. Thanks to the pen clip it is easy to attach to any jacket pocket.</p>
<p>WS-PUT-03 Magnet lifter flexible with flexible gooseneck 502 mm Weight: 120 g strength: approx. 1 kg</p>	<p>Price in EUR 1 pc. 5,07 ea. from 3 pcs. 4,57 ea. from 10 pcs. 4,13 ea.</p>	<p>Protect your back and use this gooseneck magnet picker upper to pick up metal parts from the floor or from hard-to-reach places.</p>

<p>WS-PUT-04 Magnet collector with release mechanism 100 mm diameter black Weight: 490 g</p>	<p>Price in EUR 1 pc. 9,99 ea.</p>	<p>This magnetic collector with release mechanism is perfect for picking up small metal objects.</p>
<p>WS-MNS Nail holder magnetic 145 mm long, red Weight: 20 g</p>	<p>Price in EUR 1 pc. 1,99 ea.</p>	<p>An affordable and practical magnetic tool for hammering in nails safely</p>
<p>WS-FMG-L Magnetic gloves L for nails, screws, bits, etc. pair of gloves, size L Weight: 110 g</p>	<p>Price in EUR 1 pc. 14,99 ea.</p>	<p>The magnetic glove from MagnoGrip allows you to keep nails, screws, nuts or drill bits on the back of your hand while you work. Size L.</p>
<p>WS-FMG-M Magnetic gloves M for nails, screws, bits, etc. pair of gloves, size M Weight: 110 g</p>	<p>Price in EUR 1 pc. 14,99 ea.</p>	<p>The magnetic glove from MagnoGrip allows you to keep nails, screws, nuts or drill bits on the back of your hand while you work. Size M.</p>
<p>WS-MDH-01 Holster magnetic for drill and accessories Weight: 230 g</p>	<p>Price in EUR 1 pc. 14,99 ea.</p>	<p>The magnetic drill holster from MagnoGrip is built to provide fast access to your cordless drill.</p>
<p>WS-MNP-01 Tool pouch magnetic small for nails, screws, bits, etc. with 3 pockets Weight: 230 g</p>	<p>Price in EUR 1 pc. 7,99 ea.</p>	<p>The magnetic nail pouch from MagnoGrip provides easy access to metal parts or tools while you work.</p>
<p>WS-MTP-01 Tool belt magnetic large with 10 pockets & belt Weight: 670 g</p>	<p>Price in EUR 1 pc. 14,99 ea.</p>	<p>The large magnetic bag with belt offers easy access to small metal parts or tools while at work.</p>
<p>WS-MTR-01 Magnetic bowl small for nails, screws, bits, etc. 108 x 22 mm Weight: 190 g</p>	<p>Price in EUR 1 pc. 2,57 ea. from 3 pcs. 2,34 ea. from 10 pcs. 2,13 ea.</p>	<p>The search for paper clips and screws is finally over! Small metal parts can be stored safely and in style in the small magnetic bowl made of chrome steel.</p>
<p>WS-MTR-02 Magnetic bowl large for nails, screws, bits, etc. 148 x 25 mm Weight: 350 g</p>	<p>Price in EUR 1 pc. 3,22 ea. from 3 pcs. 2,97 ea. from 10 pcs. 2,75 ea.</p>	<p>The search for paper clips and screws is finally over! Small metal parts can be stored safely and in style in the large magnetic bowl made of chrome steel.</p>

<p>WS-MTR-03 Magnetic bowl rectangular for nails, screws, bits, etc. 237 x 136 x 28 mm Weight: 500 g</p>	<p>Price in EUR 1 pc. 4,99 ea. from 3 pcs. 4,63 ea. from 10 pcs. 4,31 ea.</p>	<p>The search for paper clips and screws is finally over! Small metal parts can be stored safely and in style in the rectangular magnetic bowl made of chrome steel.</p>
<p>WS-MTR-04 Magnetic bowl collapsible made of rubber for nails, screws, bits, etc. Weight: 200 g</p>	<p>Price in EUR 1 pc. 3,99 ea. from 3 pcs. 3,73 ea. from 10 pcs. 3,50 ea.</p>	<p>This magnetic bowl made of soft rubber can be folded flat to bring with you or store away - it doesn't take much room. Diameter 135 mm.</p>
<p>WS-WLD-01 Welding magnet small magnetic welding angle with on/off switch side length approx. 9,5 cm Weight: 640 g</p>	<p>Price in EUR 1 pc. 20,27 ea. from 3 pcs. 18,78 ea. from 10 pcs. 17,45 ea.</p>	<p>The little welding helper works with steel, sheets, pipes, brackets and round material.</p>
<p>WS-WLD-02 Welding magnet large magnetic welding angle with on/off switch side length approx. 12 cm Weight: 1,3 kg</p>	<p>Price in EUR 1 pc. 30,31 ea. from 3 pcs. 28,12 ea. from 10 pcs. 26,15 ea.</p>	<p>The big welding helper works with steel, sheets, pipes, brackets and round material.</p>
<p>WS-WSF-01 Clipboard aluminium magnetic with clamp A4 format Weight: 290 g</p>	<p>Price in EUR 1 pc. 18,98 ea.</p>	<p>This magnetic aluminium clipboard can be attached to all ferrous surfaces thanks to the strong magnetic tape on the backside. It works well in a production area, e.g. for hanging up maintenance schedules on machines.</p>
<p>WS-WSF-02 Clipboard black magnetic with foil coating A4 format Weight: 140 g</p>	<p>Price in EUR 1 pc. 4,22 ea.</p>	<p>This black clipboard (coated with foil) can be attached to ferrous surfaces thanks to the two embedded neodymium magnets on the backside. It works great in a production area, e.g. to hang up maintenance plans on machines.</p>
<p>WS-WSF-03 Clipboard black with foil coating and sheet protector A4 format not magnetic! Weight: 140 g</p>	<p>Price in EUR 1 pc. 3,63 ea.</p>	<p>Practical clipboard with black foil coating and sheet protector on the backside. Thanks to the suspension eye, it can be hung up on the wall if necessary.</p>
<p>M-32 Rubber tape self-adhesive increases adhesive force in shear direction 10 x 5 cm Weight: 1,5 g</p>	<p>Price in EUR 1 pc. 2,40 ea. from 3 pcs. 2,17 ea. from 10 pcs. 1,90 ea. from 20 pcs. 1,81 ea. from 40 pcs. 1,72 ea.</p>	<p>This tape can prevent a magnet from sliding down. The silicone rubber tape increases the sticking friction between magnet and surface and thereby counteracts the diminished adhesive force in shear direction.</p>
<p>WS-BIT-01 Bitpass magnetic bit holder for wrist or cordless screwdriver including 6 bits Weight: 32 g</p>	<p>Price in EUR 1 pc. 19,99 ea.</p>	<p>Bitpass is a magnetic bit holder for quick bit exchanges (screwdriver bits). Included in the delivery are 6 bits (1x TX 15, 1x TX 20, 1x TX 25, 1x TX 30, 1x PZ 2, 1x PH 2).</p>

WS-MST-01 Magnet separator hand tool to separate magnets Weight: 190 g	Price in EUR 1 pc. 89,90 ea.	The magnet separator is suitable for magnet shapes such as cubes, blocks, discs, rods and rings. Please refer to the product description on our website for allowable maximum measurements of the magnets.
MCS-1208 Case mini 208 x 144 x 92 mm not magnetic! Weight: 850 g	Price in EUR 1 pc. 24,99 ea.	In this plastic case you can store your magnets, but also tools and other objects. The content of the case is protected against dust and water. You can modify the included foam padding depending on the content you chose to store in there.
MCS-1233 Case mini deep 270 x 246 x 174 mm not magnetic! Weight: 1,4 kg	Price in EUR 1 pc. 28,99 ea.	In this plastic case you can store your magnets, but also tools and other objects. The content of the case is protected against dust and water. You can modify the included foam padding depending on the content you chose to store in there.
MCS-1300 Case medium 339 x 295 x 152 mm not magnetic! Weight: 1,8 kg	Price in EUR 1 pc. 49,99 ea.	In this plastic case you can store your magnets, but also tools and other objects. The content of the case is protected against dust and water. You can modify the included foam padding depending on the content you chose to store in there.

(Magnetic) car accessories

<p>M-89 Windscreen protection foil 2 in 1 sun & frost protection all in one for magnetic attachment on the car Weight: 390 g</p>	<p>Price in EUR 1 pc. 14,99 ea.</p>	<p>This protective foil is an extremely practical windscreen cover in the summer and winter alike: It keeps your car cool in the summer and protects the windscreen from frost or snow in the winter.</p>
<p>M-VM-01 Mobile phone mount Car magnetic mobile phone mount attaches to the air vent Weight: 50 g/set</p>	<p>Price in EUR 1 set 9,90/set</p>	<p>Diameter: 33 mm Height: 33 mm Accessories: Metal Plate (self-adhesive)</p>
<p>M-ALU-0304 Alunet shade cloth 80% S sun protection for car and garden 3 x 4 m Weight: 1,4 kg</p>	<p>Price in EUR 1 pc. 137,55 ea.</p>	<p>Aluminium mesh with UV-resistant coating. Reflects 80% of solar irradiation and protects from sun burn and heat.</p>
<p>M-ALU-0305 Alunet shade cloth 80% M sun protection for car and garden 3 x 5 m Weight: 1,8 kg</p>	<p>Price in EUR 1 pc. 170,76 ea.</p>	<p>Aluminium mesh with UV-resistant coating. Reflects 80% of solar irradiation and protects from sun burn and heat.</p>
<p>M-ALU-0306 Alunet shade cloth 80% L sun protection for car and garden 3 x 6 m Weight: 2,2 kg</p>	<p>Price in EUR 1 pc. 207,62 ea.</p>	<p>Aluminium mesh with UV-resistant coating. Reflects 80% of solar irradiation and protects from sun burn and heat.</p>
<p>M-ALU-0406 Alunet shade cloth 80% XL sun protection for car and garden 4 x 6 m Weight: 3 kg</p>	<p>Price in EUR 1 pc. 276,48 ea.</p>	<p>Aluminium mesh with UV-resistant coating. Reflects 80% of solar irradiation and protects from sun burn and heat.</p>
<p>M-42 Fan fin country flag magnetic flag for the car Weight: 120 g strength: approx. 15 kg</p>	<p>Price in EUR 1 pc. 11,99 ea.</p>	<p>With this original fan fin, you can show which team you are rooting for when you are "on the road".</p>
<p>M-58 Fun fin magnetic fun item for your car Weight: 120 g strength: approx. 15 kg</p>	<p>Price in EUR 1 pc. 14,95 ea.</p>	<p>You would like to pimp your car, for instance with a pirate flag or a "Just married" sign? Pick the original magnetic fun fin.</p>

Fishing magnets and accessories for successful magnet fishing

<p>M-KH-120 Carabiner small 60 x 6 mm firefighter carabiner, galvanised holds 120 kg Weight: 26 g</p>	<p>Price in EUR 1 pc. 3,49 ea. from 5 pcs. 3,39 ea. from 10 pcs. 3,09 ea.</p>	<p>This small carabiner with a load capacity of 120 kg is very versatile. The galvanised surface inhibits the formation of rust, allowing both indoor and outdoor use of the carabiner.</p>
<p>M-KH-230S Locking carabiner 80 x 8 mm firefighter carabiner, galvanised holds 230 kg Weight: 60 g</p>	<p>Price in EUR 1 pc. 5,99 ea. from 5 pcs. 5,39 ea. from 10 pcs. 4,49 ea.</p>	<p>Sturdy carabiner with screw lock and a load capacity of 230 kg. Perfect for magnet fishing as a connector piece between rope and eyebolt / ring nut.</p>
<p>M-KH-450S Locking carabiner 120 x 11 mm firefighter carabiner, galvanised holds 450 kg Weight: 190 g</p>	<p>Price in EUR 1 pc. 10,99 ea. from 5 pcs. 9,99 ea. from 10 pcs. 8,99 ea.</p>	<p>Massive locking carabiner with a load capacity of 450 kg. The safety lock prevents an accidental opening of the carabiner.</p>
<p>M-MPB-1 Utility pouch two-way zipper with attachment loops Weight: 190 g</p>	<p>Price in EUR 1 pc. 9,99 ea.</p>	<p>Sturdy utility pouch with two-way zipper. Water-repellent inside and drainage eyelet in the bottom. Inside, elastic loop straps on both long sides. Outside, attachment loops with snap fasteners, MOLLE compatible.</p>
<p>M-MPB-2 Dump pouch 14 cm opening with attachment loops Weight: 180 g</p>	<p>Price in EUR 1 pc. 9,99 ea.</p>	<p>Sturdy dump pouch for outdoor activities. Large inner pocket with drawstring closure, 2 side pockets (one made of netting), one front pocket with hook and loop closure. 2 attachment loops with snap fasteners, MOLLE compatible.</p>
<p>M-ROPE-515 Polypropylene rope 5 mm x 15 m for magnet fishing not a climbing rope! Weight: 140 g</p>	<p>Price in EUR 1 pc. 4,99 ea.</p>	<p>This polypropylene rope is weather-resistant and durable. Ideal for magnet fishing, use around the house or garden and camping. Caution: Not suitable for climbing or lifting loads.</p>
<p>M-ROPE-560 Polypropylene rope 5 mm x 60 m for magnet fishing not a climbing rope! Weight: 670 g</p>	<p>Price in EUR 1 pc. 19,95 ea.</p>	<p>This polypropylene rope is weather-resistant and durable. Ideal for magnet fishing, use around the house or garden and camping. Caution: Not suitable for climbing or lifting loads.</p>
<p>M-ROPE-715 Polypropylene rope 7 mm x 15 m for magnet fishing not a climbing rope! Weight: 250 g</p>	<p>Price in EUR 1 pc. 9,99 ea.</p>	<p>This polypropylene rope is weather-resistant and durable. Ideal for magnet fishing, use around the house or garden and camping. Caution: Not suitable for climbing or lifting loads.</p>

<p>M-ROPE-760 Polypropylene rope 7 mm x 60 m for magnet fishing not a climbing rope! Weight: 1,1 kg</p>	<p>Price in EUR 1 pc. 39,96 ea.</p>	<p>This polypropylene rope is weather-resistant and durable. Ideal for magnet fishing, use around the house or garden and camping. Caution: Not suitable for climbing or lifting loads.</p>
<p>M-ROPE-915 Polypropylene rope 9 mm x 15 m for magnet fishing not a climbing rope! Weight: 360 g</p>	<p>Price in EUR 1 pc. 14,99 ea.</p>	<p>This polypropylene rope is weather-resistant and durable. Ideal for magnet fishing, use around the house or garden and camping. Caution: Not suitable for climbing or lifting loads.</p>
<p>M-ROPE-960 Polypropylene rope 9 mm x 60 m for magnet fishing not a climbing rope! Weight: 1,6 kg</p>	<p>Price in EUR 1 pc. 59,96 ea.</p>	<p>This polypropylene rope is weather-resistant and durable. Ideal for magnet fishing, use around the house or garden and camping. Caution: Not suitable for climbing or lifting loads.</p>
<p>M-TH-TR100 Fishing magnet 100 magnetic on both sides 2x M8 threads incl. matching eyebolt strength approx. 100 kg Weight: 480 g</p>	<p>Price in EUR 1 pc. 34,86 ea. from 3 pcs. 30,71 ea. from 10 pcs. 27,00 ea.</p>	<p>Fishing magnet with 100 kg adhesive force, magnetic on both sides. In other words, two strong neodymium magnets with 100 kg adhesive force each are located on the top and bottom. Included in the delivery: Fishing magnet and eyebolt M8. Not a toy!</p>
<p>M-TH-TR200 Fishing magnet 200 magnetic on both sides 2x M10 threads incl. matching eyebolt strength approx. 200 kg Weight: 1,1 kg</p>	<p>Price in EUR 1 pc. 47,68 ea. from 3 pcs. 42,13 ea. from 10 pcs. 37,17 ea.</p>	<p>Fishing magnet with 200 kg adhesive force, magnetic on both sides. In other words, two strong neodymium magnets with 200 kg adhesive force each are located on the top and bottom. Included in the delivery: Fishing magnet and eyebolt M10. Not a toy!</p>
<p>M-TH-TR400 Fishing magnet 400 magnetic on both sides 2x M12 threads incl. matching eyebolt strength approx. 400 kg Weight: 3,3 kg</p>	<p>Price in EUR 1 pc. 94,08 ea. from 3 pcs. 83,67 ea.</p>	<p>Fishing magnet with 400 kg adhesive force, magnetic on both sides. By far the strongest neodymium magnet in our assortment! Included in the delivery: Fishing magnet and eyebolt M12. Not a toy!</p>
<p>M-TH-D30 Treasure hunter magnet David 30 retrieval magnet with 15 m nylon cord Weight: 300 g strength: approx. 30 kg</p>	<p>Price in EUR 1 pc. 34,99 ea.</p>	<p>Retrieving magnet David 30 with 30 kg adhesive force, incl. 15 m long nylon rope. Perfect for beginners to gain initial magnet fishing experience.</p>
<p>M-TH-D45 Treasure hunter magnet David 45 retrieval magnet with eyebolt and 15 m nylon rope Weight: 680 g strength: approx. 45 kg</p>	<p>Price in EUR 1 pc. 49,99 ea.</p>	<p>The retrieval magnet David 45 with its 45 kg adhesive force is perfect for beginners. It comes with a 15 m long nylon rope that can be attached to the magnet. An eyebolt M8 is also included in the delivery.</p>

Miscellaneous

Here you can find special magnets as well as magnet accessories.

<p>CYL-M4-10 Cylinder screw with hexagon socket M4 length 10 mm without shaft according to SN EN ISO 4762, not magnetic! Weight: 3 g</p>	<p>Price in EUR 10 pcs. 0,20 ea. from 500 pcs. 0,15 ea. from 1000 pcs. 0,10 ea.</p>	<p>These cylinder screws with a hexagon socket and M4 thread are made of rust-proof stainless steel and therefore very sturdy.</p>
<p>CYL-M5-10 Cylinder screw with hexagon socket M5 length 10 mm without shaft according to SN EN ISO 4762, not magnetic! Weight: 3 g</p>	<p>Price in EUR 10 pcs. 0,20 ea. from 500 pcs. 0,15 ea. from 1000 pcs. 0,10 ea.</p>	<p>These cylinder screws with a hexagon socket and M5 thread are made of rust-proof stainless steel and therefore very sturdy.</p>
<p>M-94 Test tube for decoration purposes not heat or fire resistant! Weight: 9 g</p>	<p>Price in EUR 1 pc. 1,49 ea.</p>	<p>Length: 160 mm Diameter: 16 mm Wall thickness: 0,5 mm Material: Soda-Lime glass</p>
<p>OSC-01 Washer made of anodised aluminium in different colours not magnetic! Weight: 2 g</p>	<p>Price in EUR 10 pcs. 1,50 ea. from 500 pcs. 1,25 ea. from 1000 pcs. 1,00 ea.</p>	<p>These washers made of coloured anodised aluminium are resistant to corrosion and therefore perfect for outdoor use.</p>
<p>OSC-02 Washer cone-shaped made of anodised aluminium in different colours not magnetic! Weight: 2 g</p>	<p>Price in EUR 10 pcs. 1,50 ea. from 500 pcs. 1,25 ea. from 1000 pcs. 1,00 ea.</p>	<p>These washers made of coloured anodised aluminium are resistant to corrosion and therefore perfect for outdoor use.</p>
<p>M-HOOK-32 Magnetic hook set with scratch protection base covered with felt set of 4 Weight: 210 g/set strength: approx. 9 kg</p>	<p>Price in EUR 1 set 29,40/set from 3 sets 27,10/set from 10 sets 25,05/set from 20 sets 24,05/set from 40 sets 23,17/set</p>	<p>4 super-strong magnetic hooks for fastening the Alunet shade cloth on the car. The base of each magnet is coated in felt to avoid scratches on the vehicle.</p>
<p>M-82 Magnetic wall pins with screw and rawlplug for hanging up objects set of 5 Weight: 41 g/set</p>	<p>Price in EUR 1 set 4,99/set</p>	<p>Versatile wall pins with strong holding power, available in a set of 5. Includes screws and rawlplugs.</p>

Gift ideas: Magnetic articles for any budget

Here you can find magnetic gift items that are original and suitable for every budget.

<p>FO-8 Magnetic board slate classy and exclusive 40 x 20 cm incl. 10 strong magnets Weight: 2,2 kg</p>	<p>Price in EUR 1 pc. 40,00 ea.</p>	<p>Noble wall panel with blue-grey slate surface. 40 cm x 20 cm, made from slate from the Mosel river area, with character line (wall distance about 1 cm). Easy assembly, in portrait and landscape format. Every one of those pieces is unique.</p>
<p>LIV-40 Decorative magnet 'Diamond Star' with star motif, made of plexiglass with Swarovski crystals Weight: 13 g strength: approx. 450 g</p>	<p>Price in EUR 1 pc. 21,95 ea. from 3 pcs. 19,95 ea. from 10 pcs. 18,95 ea.</p>	<p>The star made of 250 sparkling Swarovski elements is not just for superstars but looks also nice on your refrigerator.</p>
<p>LIV-76 Magnetic bottle opener 'Ocean' attaches to the fridge set of 2 in second-hand look Weight: 250 g/set</p>	<p>Price in EUR 1 set 9,99/set</p>	<p>These nautical bottle openers bring a fresh breeze into your kitchen! You can attach them to the fridge or a metal cabinet and have them always handy.</p>
<p>M-47 Beer tree large magnetic beer cap collector ideal party gift holds up to 120 bottle caps Weight: 150 g</p>	<p>Price in EUR 1 pc. 35,99 ea.</p>	<p>For the beer tree you don't need a green thumb, you just need to be thirsty, because with every bottled beer your tree will grow a little bit. The strong magnet on the top of the tree trunk can easily hold 120 bottle caps.</p>
<p>M-40 Wall bottle opener beer bottle opener with magnetic bottle cap collector incl. mounting accessories Weight: 470 g/set</p>	<p>Price in EUR 1 set 29,90/set</p>	<p>This magnetic bottle opener not only attracts everyone's attention - it also catches the falling bottle caps. It can collect up to 60 caps that form a cluster underneath the opener.</p>
<p>FRM-03 Picture frame 18 x 13 cm with magnetic catch made of transparent acrylic glass for portrait or landscape format Weight: 830 g</p>	<p>Price in EUR 1 pc. 33,14 ea.</p>	<p>The same picture frame as Picture frame 11,5 x 9 cm, but bigger and therefore suitable for pictures of up to 17,8 x 12,7 cm.</p>
<p>M-KNIFESSET-001 Breakfast board set cutting board made of beechwood with magnetic knife holder & PanoramaKnife Weight: 370 g/set</p>	<p>Price in EUR 1 set 99,95/set</p>	<p>The perfect set for a breakfast, snack, picnic or hiking break. Features a breakfast knife and a beechwood board with magnetic knife holder, original by PanaormaKnife Switzerland.</p>
<p>M-KNIFEB-002 Knife block magnetic Pentagon made of wood for knives up to 900 g Weight: 1,8 kg</p>	<p>Price in EUR 1 pc. 99,99 ea.</p>	<p>Your knives seem to float on the "Pentagon". Thanks to the extremely strong embedded magnets, you can safely attach at least 8 knives with a weight of up to 900 g.</p>

<p>Q-70-70-30-N Block magnet 70 x 70 x 30 mm Weight: 1,1 kg Nickel-plated (Ni-Cu-Ni) Magnetisation: N40 strength: approx. 150 kg</p>	<p>Price in EUR 1 pc. 83,84 ea. from 3 pcs. 75,64 ea. from 10 pcs. 68,32 ea. from 20 pcs. 64,76 ea.</p>	<p>After the MONOLITH, the GOLIATH is the second strongest magnet in our assortment. Due to its high adhesive force, the GOLIATH is a very dangerous magnet and not suitable for magnet novices. Please follow the enclosed safety tips.</p>
<p>Z-10 Macho set magnet set case with 40 super magnets Weight: 1,4 kg/set</p>	<p>Price in EUR 1 set 59,99/set</p>	<p>For people who aren't easily impressed, we now have the supermagnete macho set! 10 large and 30 small super magnets in one tool case.</p>
<p>MON-01 Monolux magnetic candle holder in a gift box Weight: 100 g</p>	<p>Price in EUR 1 pc. 24,99 ea.</p>	<p>The Monolux always finds a place - wherever you wish for cosiness. It stays wherever there is a magnetic surface! On the fridge, on a shelf, on the stair railing and even on a pin...</p>
<p>WS-BIT-01 Bitpass magnetic bit holder for wrist or cordless screwdriver including 6 bits Weight: 32 g</p>	<p>Price in EUR 1 pc. 19,99 ea.</p>	<p>Bitpass is a magnetic bit holder for quick bit exchanges (screwdriver bits). Included in the delivery are 6 bits (1x TX 15, 1x TX 20, 1x TX 25, 1x TX 30, 1x PZ 2, 1x PH 2).</p>
<p>M-43 Wooden blocks set 27 magnetic wooden cubes made of oiled oak wood Weight: 510 g/set</p>	<p>Price in EUR 1 set 64,99/set</p>	<p>Thanks to the embedded sphere magnets, the 27 wooden cubes are magnetic on all six sides, which allows for building various imaginative constructs.</p>
<p>LIV-123 MagNICI magnetic plush toys with sewn-in magnet in each paw Weight: 22 g</p>	<p>Price in EUR 1 pc. 9,90 ea.</p>	<p>Who doesn't like the legendary NICI plush toys? We have some running around in our supermagnete assortment - naturally with magnetic feet!</p>
<p>M-ZUB-02 Zubits® M magnetic shoe closures for youth & adults in different colours Weight: 40 g/set</p>	<p>Price in EUR 1 set 20,49/set</p>	<p>Magnetic shoe closures for quick in and out of shoes. Secure hold, even when active.</p>
<p>MANI-01 Fridge magnets 'African animals' magnetic mini animals made from old tin cans sale profits go to Children's Aid Madagascar (Kinderhilfe Madagaskar) Weight: 30 g</p>	<p>Price in EUR 1 pc. 11,90 ea.</p>	<p>These magnetic animals are skilfully crafted in Madagascar from old tin cans. All sales proceeds benefit the children's aid organisation zaza malagasy in Madagascar.</p>
<p>LIV-47 Magnetic words words, syllables and punctuation marks 510 pieces available in various languages Weight: 290 g/set</p>	<p>Price in EUR 1 set 19,99/set</p>	<p>A set of magnetic words contains 510 pieces: Words, syllables and punctuation marks. Available in five languages: German, English, French, Dutch and Spanish</p>

<p>MCAR-01 Fridge magnets 'MadagasCAR' magnetic mini vehicles made of old tin cans sale profits go to Children's Aid Madagascar (Kinderhilfe Madagaskar) Weight: 30 g</p>	<p>Price in EUR 1 pc. 11,90 ea.</p>	<p>These beautiful little cars and planes are manufactured in Madagascar. Handy craftsmen make them with lots of love and creativity out of old tin cans. The entire proceeds from the sale of these little cars and planes go to the Children's Fund in Madagascar.</p>
<p>M-PUTTY-FERRO Smart putty magnetic ferromagnetic putty different colours magnet not included Weight: 140 g</p>	<p>Price in EUR 1 pc. 12,95 ea.</p>	<p>The magnetic smart putty impresses with cool tricks and fascinating effects. As soon as a super magnet is nearby, the smart putty seems to come to life. Available in many colours.</p>
<p>M-PUTTY-GLITTER Smart putty Glitter with glitter different colours not magnetic! Weight: 140 g</p>	<p>Price in EUR 1 pc. 12,95 ea.</p>	<p>Smart putty impresses with cool tricks and fascinating effects. Additional feature of the "Glitter" type: It shimmers as if millions of stars were trapped inside!</p>
<p>M-PUTTY-GLOW Smart putty Glow glows in the dark different colours not magnetic! Weight: 140 g</p>	<p>Price in EUR 1 pc. 12,95 ea.</p>	<p>Smart putty impresses with cool tricks and fascinating effects. The model "Glow" even glows in the dark.</p>
<p>FL-10 Photo rope "Sweetheart" 1,5 m with loop and steel weight incl. 8 heart magnets Weight: 70 g</p>	<p>Price in EUR 1 pc. 17,44 ea. from 3 pcs. 15,70 ea. from 10 pcs. 14,15 ea. from 20 pcs. 13,40 ea. from 40 pcs. 12,73 ea.</p>	<p>1,5 m long photo rope with 8 cute and magnetic metal hearts. For the sweetest photos and cards!</p>
<p>LIV-90 Decorative magnet 'Red Heart' acrylic red heart with zircon incl. organza fabric pouch Weight: 8 g strength: approx. 1,5 kg</p>	<p>Price in EUR 1 pc. 5,49 ea.</p>	<p>Not just for Valentines Day! A red acrylic heart with a little sparkling zircon on the top right. On the backside there is a strong neodymium magnet 12 x 2 mm embedded to hold all those love notes. Each heart is packaged in a silver fabric bag and makes for a great gift.</p>
<p>LIV-95 Magnetic plush toys with sewn-in magnets in each front paw Weight: 20 g</p>	<p>Price in EUR 1 pc. 7,49 ea.</p>	<p>Thanks to the strong magnets inside, the friendly fluffy animals adhere to fridge or magnetic board. You can select from 10 different animal species.</p>
<p>LIV-119 Glass magnets lucky charm handmade fridge magnets set of 3 Weight: 18 g/set</p>	<p>Price in EUR 1 set 11,55/set</p>	<p>Pretty glass magnets with lucky charms. Handmade in Switzerland.</p>
<p>LIV-52 Sheep magnets fridge magnets shaped as sheep set of 6 Weight: 73 g/set strength: approx. 550 g</p>	<p>Price in EUR 1 set 9,99/set</p>	<p>Shepard wanted! This flock of sheep is looking for someone to take care of them. Who could resist these trusting eyes?</p>

<p>LIV-91 Decorative magnet 'Diamond Cat' white cat made of plexiglass with Swarovski crystals Weight: 15 g strength: approx. 1,5 kg</p>	<p>Price in EUR 1 pc. 21,95 ea. from 3 pcs. 19,95 ea. from 10 pcs. 18,95 ea.</p>	<p>The white kitty sparkles thanks to white and coloured Swarovski crystals. Through the worldwide unique IMPLEXIONS technique, the precious SWAROVSKI® crystals are embedded seamlessly and without bubbles in high-quality Plexiglas®. The cat measures approx. 42 x 47 mm.</p>
<p>LIV-38 Decorative magnet 'Diamond Heart' with heart motif, made of plexiglass with Swarovski crystals Weight: 13 g strength: approx. 450 g</p>	<p>Price in EUR 1 pc. 23,45 ea. from 3 pcs. 21,59 ea. from 10 pcs. 19,96 ea.</p>	<p>The sparkling diamond heart is not only a head turner, it also holds on to love notes and other memos. Square.</p>
<p>M-41 Tangram cube made of 24 magnetic tetrahedrons with 20 templates Weight: 590 g</p>	<p>Price in EUR 1 pc. 27,47 ea.</p>	<p>You need all your wits for this game! The Tangram cube consists of 24 magnetic plastic pyramids. With these tetrahedrons you can also build more challenging shapes and figures.</p>
<p>M-38 Letters or numbers magnetic set of magnetic symbols made of EVA foam 4 assorted colours Weight: 350 g/set</p>	<p>Price in EUR 1 set 17,37/set</p>	<p>Each box of magnetic letters and numbers contains approx. 100 foam symbols, which contain a magnetic sheet on the back that makes them adhere to metal surfaces, such as blackboards and whiteboards and even magnetic paint.</p>
<p>LIV-111 Building block magnets 'Classic' with press-fitted magnets assorted set of 14 Weight: 27 g/set</p>	<p>Price in EUR 1 set 11,00/set</p>	<p>Coloured bricks in seven bright colours with pressed-in neodymium magnets.</p>

Magnet bestsellers

You are not sure which magnets to buy from our huge assortment? You can't do no wrong with these magnets! They are the absolute bestsellers of recent years because they are extremely versatile and have a great price-performance ratio.

We aim to have plenty of these important articles in stock.

<p>M-FERROTAPE Metal tape self-adhesive white 35 mm self-adhesive surface for magnets rolls of 1 m / 5 m / 25 m Weight: 75 g/m</p>	<p>Price in EUR 1 m 5,59/m from 5 m 3,86/m from 25 m 2,81/m</p>	<p>Metal tape with self-adhesive cushioning on the back. The strip can be cut with normal scissors to the desired length, since it is only 0,15 mm thick. It also adheres to textured walls and is easy to install around corners.</p>
<p>Q-51-51-25-N Block magnet 50,8 x 50,8 x 25,4 mm Weight: 500 g Nickel-plated (Ni-Cu-Ni) Magnetisation: N40 strength: approx. 100 kg</p>	<p>Price in EUR 1 pc. 43,33 ea. from 3 pcs. 38,47 ea. from 10 pcs. 34,13 ea.</p>	<p>We call this magnet THE DEATH MAGNET. I have no idea what you can reasonably do with this magnet - it is simply too intense for most applications. BE CAREFUL!!!</p>
<p>M-PIN Magnetic pins "Player" bulletin board magnets in the shape of a pawn in a game, Ø 12,5 mm set of 10 in different colours Weight: 28 g/set strength: approx. 1,6 kg</p>	<p>Price in EUR 1 set 13,80/set from 3 sets 11,92/set from 10 sets 10,24/set from 20 sets 9,42/set</p>	<p>Very strong magnetic pin with practical knob. Holds ten A4 sheets of paper with no problem. In various colours. Set of 10 pins.</p>
<p>MS-A4-STIC Self-adhesive magnetic sheet A4 format to cut & glue grey-black Weight: 230 g</p>	<p>Price in EUR 1 pc. 4,00 ea. from 3 pcs. 3,47 ea. from 10 pcs. 3,00 ea. from 20 pcs. 2,77 ea. from 40 pcs. 2,56 ea.</p>	<p>The A4 magnetic sheet with self-adhesive side can be cut to the desired size and lends itself to hanging up larger objects that require an increased adhesive force.</p>
<p>MS-A4 Coloured magnetic sheet for labelling and arts & crafts A4 format Weight: 230 g</p>	<p>Price in EUR 1 pc. 3,90 ea. from 3 pcs. 3,38 ea. from 10 pcs. 2,92 ea. from 20 pcs. 2,69 ea. from 40 pcs. 2,50 ea.</p>	<p>For labelling, arts & crafts, marking - the only limit is your imagination. The A4 magnetic sheets are available in 13 different colours. The sheet is 1 mm thick and you can cut it and write on it.</p>
<p>MT-20-STIC Magnetic adhesive tape ferrite 20 mm self-adhesive magnetic tape rolls of 1 m / 5 m / 25 m Weight: 110 g/m</p>	<p>Price in EUR 1 m 2,64/m from 5 m 2,10/m from 25 m 1,69/m from 50 m 1,55/m from 75 m 1,47/m</p>	<p>The self-adhesive magnetic tape MT-20-STIC can attach non-magnetic objects to metal surfaces. This magnetic tape is 20 mm wide and available in lengths of 1 m, 5 m and 25 m.</p>
<p>MT-DISP Magnetic adhesive tape for photos 5 m in dispenser Weight: 150 g</p>	<p>Price in EUR 1 pc. 5,25 ea. from 3 pcs. 4,52 ea. from 10 pcs. 3,85 ea. from 20 pcs. 3,53 ea. from 40 pcs. 3,25 ea.</p>	<p>The tape that is both adhesive and magnetic. It attaches photos, postcards and other lightweight things easily and quickly to ferromagnetic surfaces, without making holes.</p>
<p>WS-ADH-01 UHU MAX REPAIR magnet glue waterproof, without solvents 20 g tube Weight: 20 g</p>	<p>Price in EUR 1 pc. 7,95 ea. (39,75/100 g)</p>	<p>Do you need a reliable adhesive for your super magnet application? We can recommend this adhesive with conviction. Suitable to use on wood, fabric, leather, cork, metal, glass, plastic, rubber, ceramic, stone or cement.</p>

<p>LIV-79 Magnetic clips "Graffa" XL with very high adhesive force set of 2 Weight: 70 g/set</p>	<p>Price in EUR 1 set 11,99/set</p>	<p>Two strong magnetic clips that adhere to any metal surface. You can attach calendars, recipes or magazines to always have them handy. Thanks to the non-slip coating, these clips stay in place even with heavy objects on them.</p>
<p>M-PUTTY-FERRO Smart putty magnetic ferromagnetic putty different colours magnet not included Weight: 140 g</p>	<p>Price in EUR 1 pc. 12,95 ea.</p>	<p>The magnetic smart putty impresses with cool tricks and fascinating effects. As soon as a super magnet is nearby, the smart putty seems to come to life. Available in many colours.</p>
<p>FTN-32 Hook magnet Ø 32 mm Thread M5 Weight: 52 g strength: approx. 30 kg</p>	<p>Price in EUR 1 pc. 5,14 ea. from 3 pcs. 4,52 ea. from 10 pcs. 3,97 ea. from 20 pcs. 3,70 ea. from 40 pcs. 3,47 ea.</p>	<p>Pot diameter D: 32 mm Neck diameter d: 10 mm Pot height H1: 7 mm Total height without hook H2: 15,5 mm with hook H3: 45 mm</p>
<p>CSN-13 Countersunk pot magnet Ø 13 mm Weight: 3 g strength: approx. 3 kg</p>	<p>Price in EUR 5 pcs. 1,62 ea. from 15 pcs. 1,40 ea. from 40 pcs. 1,24 ea. from 80 pcs. 1,14 ea.</p>	<p>Diameter D: 13 mm Total height H: 4,5 mm Borehole d1: 3 mm Borehole d2: 5,5 mm Countersinking t: 1,25 mm Tolerance: +/- 0,1 mm</p>
<p>CSN-16 Countersunk pot magnet Ø 16 mm Weight: 5 g strength: approx. 4 kg</p>	<p>Price in EUR 5 pcs. 1,69 ea. from 15 pcs. 1,46 ea. from 40 pcs. 1,29 ea. from 80 pcs. 1,19 ea.</p>	<p>Diameter D: 16 mm Total height H: 4,5 mm Borehole d1: 3,5 mm Borehole d2: 7,22 mm Countersinking t: 1,86 mm Tolerance: +/- 0,1 mm</p>
<p>CSN-ES-16 Countersunk pot magnet Ø 16 mm Weight: 5,5 g strength: approx. 6,9 kg</p>	<p>Price in EUR 5 pcs. 1,72 ea. from 15 pcs. 1,49 ea. from 40 pcs. 1,32 ea. from 80 pcs. 1,21 ea.</p>	<p>Similar dimensions as CSN-16, but with a thicker steel pot. Hence higher adhesive force than CSN-16.</p>
<p>CSN-20 Countersunk pot magnet Ø 20 mm Weight: 11 g strength: approx. 8,9 kg</p>	<p>Price in EUR 1 pc. 2,89 ea. from 3 pcs. 2,51 ea. from 10 pcs. 2,17 ea. from 20 pcs. 2,00 ea. from 40 pcs. 1,85 ea.</p>	<p>Diameter D: 20 mm Total height H: 6 mm Borehole d1: 4,5 mm Borehole d2: 9,46 mm Countersinking t: 2,48 mm Tolerance: +/- 0,1 mm</p>
<p>CSN-ES-20 Countersunk pot magnet Ø 20 mm Weight: 12 g strength: approx. 11 kg</p>	<p>Price in EUR 1 pc. 3,14 ea. from 3 pcs. 2,73 ea. from 10 pcs. 2,36 ea. from 20 pcs. 2,18 ea. from 40 pcs. 2,03 ea.</p>	<p>Similar dimensions as CSN-20, but with a thicker steel pot. Hence higher adhesive force than CSN-20.</p>
<p>CSN-25 Countersunk pot magnet Ø 25 mm Weight: 20 g strength: approx. 19 kg</p>	<p>Price in EUR 1 pc. 3,82 ea. from 3 pcs. 3,34 ea. from 10 pcs. 2,91 ea. from 20 pcs. 2,70 ea. from 40 pcs. 2,52 ea.</p>	<p>Diameter D: 25 mm Total height H: 7 mm Borehole d1: 5,5 mm Borehole d2: 11,7 mm Countersinking t: 3,1 mm Tolerance: +/- 0,1 mm</p>

<p>CSN-32 Countersunk pot magnet Ø 32 mm Weight: 35 g strength: approx. 30 kg</p>	<p>Price in EUR 1 pc. 5,94 ea. from 3 pcs. 5,24 ea. from 10 pcs. 4,62 ea. from 20 pcs. 4,31 ea. from 40 pcs. 4,05 ea.</p>	<p>Diameter D: 32 mm Total height H: 7 mm Borehole d1: 5,5 mm Borehole d2: 11,7 mm Countersinking t: 3,1 mm Tolerance: +/- 0,1 mm</p>
<p>GTN-25 Pot magnet with threaded stud Ø 25 mm Thread M5 Weight: 27 g strength: approx. 25 kg</p>	<p>Price in EUR 1 pc. 4,05 ea. from 3 pcs. 3,55 ea. from 10 pcs. 3,10 ea. from 20 pcs. 2,88 ea. from 40 pcs. 2,69 ea.</p>	<p>Pot diameter D: 25 mm Pot height H1: 8 mm Total height H2: 16,5 mm Tolerance: +/- 0,1 mm Coating: Nickel-plated (Ni-Cu-Ni) Max. working temperature: 80°C</p>
<p>K-05-N Sphere magnet Ø 5 mm Weight: 0,5 g Nickel-plated (Ni-Cu-Ni) Magnetisation: N35 strength: approx. 300 g</p>	<p>Price in EUR 20 pcs. 0,17 ea. from 60 pcs. 0,15 ea. from 140 pcs. 0,14 ea. from 360 pcs. 0,13 ea.</p>	<p>Nickel-coated small sphere magnets for endless combining and experimenting. Available in units of 10. ATTENTION: Not suitable for children under 14!</p>
<p>S-02-01-N Disc magnet Ø 2 mm, height 1 mm Weight: 0,024 g Nickel-plated (Ni-Cu-Ni) Magnetisation: N48 strength: approx. 110 g</p>	<p>Price in EUR 20 pcs. 0,22 ea. from 60 pcs. 0,18 ea. from 140 pcs. 0,16 ea. from 360 pcs. 0,14 ea.</p>	<p>Bestseller: More than 2 million sold!</p>
<p>S-04-02-N Disc magnet Ø 4 mm, height 2 mm Weight: 0,19 g Nickel-plated (Ni-Cu-Ni) Magnetisation: N45 strength: approx. 420 g</p>	<p>Price in EUR 20 pcs. 0,25 ea. from 60 pcs. 0,21 ea. from 140 pcs. 0,18 ea. from 360 pcs. 0,16 ea.</p>	<p>Bestseller: More than 4,75 million sold!</p>
<p>S-05-03-N Disc magnet Ø 5 mm, height 3 mm Weight: 0,45 g Nickel-plated (Ni-Cu-Ni) Magnetisation: N42 strength: approx. 700 g</p>	<p>Price in EUR 10 pcs. 0,32 ea. from 40 pcs. 0,26 ea. from 80 pcs. 0,23 ea. from 160 pcs. 0,21 ea.</p>	<p>More than 5,6 million sold</p>
<p>S-05-05-N Disc magnet Ø 5 mm, height 5 mm Weight: 0,75 g Nickel-plated (Ni-Cu-Ni) Magnetisation: N45 strength: approx. 940 g</p>	<p>Price in EUR 20 pcs. 0,31 ea. from 60 pcs. 0,27 ea. from 140 pcs. 0,24 ea. from 360 pcs. 0,21 ea.</p>	<p>Even this small magnet, which weighs less than 1 gramme, is able to attract another magnet through a human finger.</p>
<p>S-05-08-N Rod magnet Ø 5 mm, height 8,47 mm Weight: 1,3 g Nickel-plated (Ni-Cu-Ni) Magnetisation: N45 strength: approx. 1,1 kg</p>	<p>Price in EUR 10 pcs. 0,42 ea. from 40 pcs. 0,35 ea. from 80 pcs. 0,32 ea. from 160 pcs. 0,29 ea.</p>	<p>Very small, strong rod magnet. This magnet is especially suitable as a fridge magnet, for use on a magnetic board, or on a magnetic strip. It has an enormous adhesive force and is also comfortable to hold.</p>
<p>S-08-02-N Disc magnet Ø 8 mm, height 2 mm Weight: 0,76 g Nickel-plated (Ni-Cu-Ni) Magnetisation: N45 strength: approx. 1,1 kg</p>	<p>Price in EUR 20 pcs. 0,32 ea. from 60 pcs. 0,27 ea. from 140 pcs. 0,24 ea. from 360 pcs. 0,21 ea.</p>	<p>A small flat neodymium magnet with an adhesive force of about 1 kg. Our customers use it, for instance, for magnetic buttons or manual training in school.</p>

<p>S-08-03-N Disc magnet Ø 8 mm, height 3 mm Weight: 1,1 g Nickel-plated (Ni-Cu-Ni) Magnetisation: N45 strength: approx. 1,5 kg</p>	<p>Price in EUR 20 pcs. 0,34 ea. from 60 pcs. 0,29 ea. from 140 pcs. 0,26 ea. from 360 pcs. 0,23 ea.</p>	<p>A good size for various craft projects, name tags at weddings, small refrigerator magnets, hanging-up posters...</p>
<p>S-08-08-N Disc magnet Ø 8 mm, height 8 mm Weight: 3,1 g Nickel-plated (Ni-Cu-Ni) Magnetisation: N45 strength: approx. 2,5 kg</p>	<p>Price in EUR 10 pcs. 0,59 ea. from 40 pcs. 0,49 ea. from 80 pcs. 0,45 ea. from 160 pcs. 0,42 ea.</p>	<p>This disc magnet works well on magnetic glass boards.</p>
<p>S-08-0.75-STIC Disc magnet self-adhesive Ø 8 mm, height 0,75 mm Weight: 0,29 g Nickel-plated (Ni-Cu-Ni) Magnetisation: N35 strength: approx. 320 g Adhesive: 3M, No. 467MP Shelf life adhesive: 12 months (approx.) Path additional document: 3M_200MP_Adhesive_Family_TDS_2017.pdf Label additional document: Adhesive data sheet</p>	<p>Price in EUR 20 pcs. 0,25 ea. from 60 pcs. 0,21 ea. from 140 pcs. 0,19 ea. from 360 pcs. 0,16 ea.</p>	<p>No more annoying holes in your designer clothing: S-08-0.75-STIC holds name tags elegantly and without safety pins.</p>
<p>S-10-01-STIC Disc magnet self-adhesive Ø 10 mm, height 1 mm Weight: 0,6 g Nickel-plated (Ni-Cu-Ni) Magnetisation: N35 strength: approx. 540 g Adhesive: 3M, No. 467MP Shelf life adhesive: 12 months (approx.) Path additional document: 3M_200MP_Adhesive_Family_TDS_2017.pdf Label additional document: Adhesive data sheet</p>	<p>Price in EUR 20 pcs. 0,28 ea. from 60 pcs. 0,24 ea. from 140 pcs. 0,21 ea. from 360 pcs. 0,19 ea.</p>	<p>The convenient solution if you want to glue on the S-10-01-N. This is a flat disc magnet with a self-adhesive side. Just peel off the film and glue it on. One sales unit contains 10 magnetic pairs that attract each other.</p>
<p>S-10-02-N Disc magnet Ø 10 mm, height 2 mm Weight: 1,2 g Nickel-plated (Ni-Cu-Ni) Magnetisation: N42 strength: approx. 1,3 kg</p>	<p>Price in EUR 20 pcs. 0,35 ea. from 60 pcs. 0,30 ea. from 140 pcs. 0,27 ea. from 360 pcs. 0,24 ea.</p>	<p>An adhesive force of about 1 kg with a 10 mm diameter and a 2 mm thickness make this disc magnet a top seller. It might be because you can embed it nicely.</p>
<p>S-10-03-N Disc magnet Ø 10 mm, height 3 mm Weight: 1,8 g Nickel-plated (Ni-Cu-Ni) Magnetisation: N42 strength: approx. 1,8 kg</p>	<p>Price in EUR 10 pcs. 0,45 ea. from 40 pcs. 0,37 ea. from 80 pcs. 0,33 ea. from 160 pcs. 0,31 ea.</p>	<p>This reasonably priced magnet is wonderfully suitable for various craft projects. If you, for example, glue it to glass beads, you will have a very strong refrigerator or whiteboard magnet that can easily hold 15 pieces of A4 paper!</p>
<p>S-10-05-N Disc magnet Ø 10 mm, height 5 mm Weight: 3 g Nickel-plated (Ni-Cu-Ni) Magnetisation: N42 strength: approx. 2,6 kg</p>	<p>Price in EUR 10 pcs. 0,57 ea. from 40 pcs. 0,48 ea. from 80 pcs. 0,44 ea. from 160 pcs. 0,41 ea.</p>	<p>These handy all-purpose magnets are so nicely-sized and so strong for such an unbelievable price that there will be no excuse for finding yourself without them in an emergency. :-)</p>
<p>S-10-10-N Disc magnet Ø 10 mm, height 10 mm Weight: 6 g Nickel-plated (Ni-Cu-Ni) Magnetisation: N45 strength: approx. 3,9 kg</p>	<p>Price in EUR 5 pcs. 0,92 ea. from 15 pcs. 0,80 ea. from 40 pcs. 0,72 ea. from 80 pcs. 0,66 ea.</p>	<p>In between disc magnet and rod magnet. With almost 4 kg adhesive force extremely strong for its size. Great price-performance ratio.</p>
<p>S-15-03-N Disc magnet Ø 15 mm, height 3 mm Weight: 4 g Nickel-plated (Ni-Cu-Ni) Magnetisation: N45 strength: approx. 3,2 kg</p>	<p>Price in EUR 5 pcs. 0,73 ea. from 15 pcs. 0,63 ea. from 40 pcs. 0,56 ea. from 80 pcs. 0,52 ea.</p>	<p>Top seller! For this disc magnet with its adhesive force of approx. 3 kg, normal whiteboard and magnetic board applications do not present a real challenge. This magnet is simply created for a higher purpose and it favours a heavier burden.</p>

<p>S-15-08-N Disc magnet Ø 15 mm, height 8 mm Weight: 11 g Nickel-plated (Ni-Cu-Ni) Magnetisation: N42 strength: approx. 6,2 kg</p>	<p>Price in EUR 5 pcs. 1,30 ea. from 15 pcs. 1,14 ea. from 40 pcs. 1,02 ea. from 80 pcs. 0,95 ea.</p>	<p>A good in-between size! Not so painfully big, but definitely impressively strong. This magnet can hold 35 sheets of A4 paper on a metal cabinet. If this one is not going to be a big hit, I'll go get another job.</p>
<p>S-20-02-N Disc magnet Ø 20 mm, height 2 mm Weight: 4,8 g Nickel-plated (Ni-Cu-Ni) Magnetisation: N45 strength: approx. 2,9 kg</p>	<p>Price in EUR 5 pcs. 0,88 ea. from 15 pcs. 0,77 ea. from 40 pcs. 0,68 ea. from 80 pcs. 0,63 ea.</p>	<p>An extremely flat disc magnet with an adhesive force of 2 kg. Affordable and discreet - one of our bestsellers! Perfect for closures and fasteners of all kind.</p>
<p>S-20-02-FOAM Disc magnet self-adhesive Ø 20 mm, height 2 mm Weight: 4,8 g Nickel-plated (Ni-Cu-Ni) Magnetisation: N35 strength: approx. 2,3 kg Adhesive: 3M, No. 4920, 0,40 mm Shelf life adhesive: 18 months (approx.) Path additional document: data_sheet_3m_4920.pdf Label additional document: Adhesive data sheet</p>	<p>Price in EUR 10 pcs. 0,84 ea. from 40 pcs. 0,73 ea. from 80 pcs. 0,68 ea. from 160 pcs. 0,64 ea.</p>	<p>The convenient solution if you want to glue on the magnet S-20-02-N. This is a flat disc magnet with a self-adhesive side made of cushion foam. Just remove the foil and glue it on. One sales unit contains 5 magnet pairs.</p>
<p>S-20-05-N Disc magnet Ø 20 mm, height 5 mm Weight: 12 g Nickel-plated (Ni-Cu-Ni) Magnetisation: N42 strength: approx. 6,4 kg</p>	<p>Price in EUR 5 pcs. 1,36 ea. from 15 pcs. 1,20 ea. from 40 pcs. 1,07 ea. from 80 pcs. 1,00 ea.</p>	<p>If you have to keep an eye on the thickness, for example, embedding a magnet in a cabinet door, then this 5 mm thin magnet is just the thing... and it still has an impressive attractive force!</p>
<p>S-20-10-N Disc magnet Ø 20 mm, height 10 mm Weight: 24 g Nickel-plated (Ni-Cu-Ni) Magnetisation: N42 strength: approx. 11 kg</p>	<p>Price in EUR 1 pc. 2,90 ea. from 3 pcs. 2,54 ea. from 10 pcs. 2,22 ea. from 20 pcs. 2,06 ea. from 40 pcs. 1,92 ea.</p>	<p>Wow! With this item you definitely get the most bang for your buck! Hard core! And a very good value (such prices are almost indecent).</p>
<p>W-05-N Cube magnet 5 mm Weight: 0,95 g Nickel-plated (Ni-Cu-Ni) Magnetisation: N42 strength: approx. 1,1 kg</p>	<p>Price in EUR 10 pcs. 0,37 ea. from 40 pcs. 0,30 ea. from 80 pcs. 0,27 ea. from 160 pcs. 0,25 ea.</p>	<p>A small cube magnet with 5 mm edge length. Its adhesive force of 1 kg is astounding for such a small magnet. A perfect and extremely discreet fridge or whiteboard magnet - one of our top sellers for good reason.</p>
<p>W-10-N Cube magnet 10 mm Weight: 7,6 g Nickel-plated (Ni-Cu-Ni) Magnetisation: N42 strength: approx. 3,8 kg Colour: Silver-coloured</p>	<p>Price in EUR 5 pcs. 1,40 ea. from 15 pcs. 1,22 ea. from 40 pcs. 1,09 ea. from 80 pcs. 1,00 ea.</p>	<p>Cube-shaped magnets are somewhat unusual. These are strong enough to attract each other through the thickness of a hand. It takes a bit of determination to separate two of these magnets from each other.</p>
<p>Q-05-05-03-N52N Block magnet 5 x 5 x 3 mm Weight: 0,57 g Nickel-plated (Ni-Cu-Ni) Magnetisation: N52 strength: approx. 1 kg</p>	<p>Price in EUR 20 pcs. 0,30 ea. from 60 pcs. 0,25 ea. from 140 pcs. 0,22 ea. from 360 pcs. 0,19 ea.</p>	<p>Thanks to the extremely strong N52 magnetisation, this small block magnet features an adhesive force of 1 kg.</p>
<p>Q-06-04-02-HN Block magnet 6 x 4 x 2 mm Weight: 0,36 g Nickel-plated (Ni-Cu-Ni) Magnetisation: 44H strength: approx. 640 g</p>	<p>Price in EUR 10 pcs. 0,31 ea. from 40 pcs. 0,25 ea. from 80 pcs. 0,22 ea. from 160 pcs. 0,20 ea.</p>	<p>Temperature resistant to 120 degrees Celsius.</p>

<p>Q-10-10-1.2-N52N Block magnet 10 x 10 x 1,2 mm Weight: 0,91 g Nickel-plated (Ni-Cu-Ni) Magnetisation: N52 strength: approx. 1 kg</p>	<p>Price in EUR 10 pcs. 0,49 ea. from 40 pcs. 0,40 ea. from 80 pcs. 0,36 ea. from 160 pcs. 0,32 ea.</p>	<p>Thanks to its extremely strong N52 magnetisation, this very flat block magnet has an adhesive force of 1 kg.</p>
<p>Q-40-10-05-N Block magnet 40 x 10 x 5 mm Weight: 15 g Nickel-plated (Ni-Cu-Ni) Magnetisation: N42 strength: approx. 9,5 kg</p>	<p>Price in EUR 1 pc. 2,51 ea. from 3 pcs. 2,18 ea. from 10 pcs. 1,89 ea. from 20 pcs. 1,75 ea. from 40 pcs. 1,62 ea.</p>	<p>A slim, but very strong block magnet. Very popular in the areas of interior fittings, machine construction and cabinetmaking.</p>
<p>Q-40-10-10-N Block magnet 40 x 10 x 10 mm Weight: 30 g Nickel-plated (Ni-Cu-Ni) Magnetisation: N42 strength: approx. 15 kg</p>	<p>Price in EUR 1 pc. 4,49 ea. from 3 pcs. 3,91 ea. from 10 pcs. 3,40 ea. from 20 pcs. 3,15 ea. from 40 pcs. 2,92 ea.</p>	<p>A very slim block magnet with an adhesive force of impressive 15 kg. Our customers build it into lamps or wood/metal furniture.</p>
<p>Q-20-20-05-N Block magnet 20 x 20 x 5 mm Weight: 15 g Nickel-plated (Ni-Cu-Ni) Magnetisation: N42 strength: approx. 6 kg</p>	<p>Price in EUR 1 pc. 2,52 ea. from 3 pcs. 2,19 ea. from 10 pcs. 1,90 ea. from 20 pcs. 1,76 ea. from 40 pcs. 1,63 ea.</p>	<p>A very flat, square block magnet. Very popular in the areas of metal, machine and plant construction as well as interior fittings.</p>

% SALE %: Strong magnets & magnetic products at bargain prices

Here is your chance at a bargain! The listed articles are on clearance at very reduced prices. The availability can change rapidly - check the online shop for current information.

ANI-01 Jumbo magnetic memo holder Elephant Weight: 56 g	Price in EUR 1 pc. 3,99 ea.	The cute elephant sucks everything up with his trunk.
ANI-09 Coco magnetic memo holder Monkey Weight: 56 g	Price in EUR 1 pc. 3,99 ea.	Coco the monkey likes notes better than bananas!
ANI-02 Piggy magnetic memo holder Pig Weight: 63 g	Price in EUR 1 pc. 3,99 ea.	Piglet Piggy looks at the world with the stoicism and calmness of a zen master, despite its not very diversified function as a memo holder. Get inspired!
SALE-107 Teddy magnets made of plastic, velvety set of 4 Weight: 30 g/set	Price in EUR 1 set 4,99/set	Original bear magnets in bright colours that are the highlights on any magnetic board.
SALE-106 Dog magnets made of plastic, velvety set of 5 Weight: 30 g/set	Price in EUR 1 set 4,99/set	Original dog magnets in pastel colours that highlight everything on a magnetic board.
SALE-089 Fridge magnets 'Bunny' rabbit-shaped set of 4 Weight: 55 g/set	Price in EUR 1 set 4,95/set	'Kawaii' the Japanese would say: Cute! Not just for Easter but the whole year a sweet eye catcher on the fridge.
SALE-110 Office icons square various designs set of 6 Weight: 39 g/set	Price in EUR 1 set 3,90/set	Transparent magnets with colourful symbols for daily use on the whiteboard in the office. A set includes six symbols: phone, letter, lightbulb, exclamation mark, alarm clock and checkmark.
SALE-103 Fridge magnets 'Ornament Birds' antiqued look set of 6 Weight: 190 g/set	Price in EUR 1 set 4,99/set	Bird magnets made of hand-painted tin in trendy vintage look.

<p>SALE-105 Fridge magnets 'Beetle in Glass' antiqued look set of 2 Weight: 62 g/set</p>	<p>Price in EUR 1 set 4,99/set</p>	<p>Beetle magnets made of hand-painted tin in trendy vintage look.</p>
<p>SALE-092 Glass magnets 'Jardin' with garden motifs set of 4 Weight: 100 g/set</p>	<p>Price in EUR 1 set 4,99/set</p>	<p>For all garden enthusiasts we have beautiful vintage magnets in many different green themes.</p>
<p>SALE-093 Glass magnets 'America' with American motifs set of 4 Weight: 100 g/set</p>	<p>Price in EUR 1 set 4,99/set</p>	<p>Glass magnets with classic American vintage motifs in stylish muted brown and blue shades.</p>
<p>SALE-094 Glass magnets 'Summer' with summer motifs set of 4 Weight: 100 g/set</p>	<p>Price in EUR 1 set 4,99/set</p>	<p>Finally summer! At least when you have these pretty and happy summer-themed glass magnets on your fridge!</p>
<p>SALE-095 Glass magnets 'Bouquet' with flower motifs set of 4 Weight: 100 g/set</p>	<p>Price in EUR 1 set 4,99/set</p>	<p>Cute glass magnets with French vintage flower motifs in bright colours.</p>
<p>SALE-114 Metal hooks self-adhesive square, white set of 4 not magnets! Weight: 52 g/set</p>	<p>Price in EUR 1 set 3,90/set</p>	<p>Elegant white metal hooks with strong 3M adhesive on the backside adhere securely to smooth surfaces. You receive four square white hooks.</p>
<p>SALE-115 Metal hooks self-adhesive round, blue set of 4 not magnets! Weight: 52 g/set</p>	<p>Price in EUR 1 set 3,90/set</p>	<p>Elegant round metal hooks with strong 3M adhesive on the backside adhere securely to smooth surfaces. You receive four round blue hooks.</p>
<p>SALE-096 Bottle cap magnets "Love" fridge magnets set of 4 Weight: 72 g/set</p>	<p>Price in EUR 1 set 4,99/set</p>	<p>Love, spelled out, in modern bottle cap magnets. And of course super-strong thanks to a neodymium magnet on the backside!</p>
<p>SALE-090 Fridge magnets 'Honey' bear-shaped set of 4 Weight: 27 g/set</p>	<p>Price in EUR 1 set 4,95/set</p>	<p>So sweet you would want to bite into them! Unfortunately, the honey bears are not made of sugar, but they last longer.</p>

M-OFFICE-SETRG

Clip Lounge & Opener
paperweight
letter opener
paperclip holder
Weight: 550 g

Price in EUR
1 pc. 49,99 ea.

Desk set, containing: 1) Paperweight with magnet for paperclips, 2) Classy letter opener
Colour: rose-gold. Recipient of the "German Design Award Special 2016" as Product of the Year!

Questions about our online shop

Can I buy your products in a store?

No, we do not maintain a physical store. Our products are distributed exclusively through our online shop [<https://www.supermagnete.de/eng/>].

You can get a good overview of our magnet assortment not only in our online shop but also with our PDF catalogue [<https://www.supermagnete.de/eng/downloads>]. Should you have any questions or need advice, please contact our customer service [<https://www.supermagnete.de/eng/contact>].

Do you deliver on account?

We deliver on account to

- Business customers
- Public institutions (schools, museums, universities, etc.)
- Government agencies

We reserve the right to request pre-payment from companies unknown to us or for very large orders. (See our delivery terms [<https://www.supermagnete.de/eng/conditions.php?highlight=payment>])

Delivery Terms (Germany)

Delivery Terms of Other Countries: <https://www.supermagnete.de/eng/eng/conditions/other>

Shipment

The shipment is climate-neutral and will be made by DHL from Gottmadingen (Germany). Bulk /general cargo will be delivered by our logistics partner Lamprecht or its partner companies.

Shipping Costs

There is a flat rate for shipping and handling of EUR 4,90. Deliveries to the German islands do not incur an additional charge.

VAT

All shop prices include German VAT.

Delivery time

Delivery time is between 2 and 4 business days within Germany and from 2 to 10 working days into the remaining EU.

Payment

•Pre-payment to our account in Germany

We will send you our account details via e-mail with the order confirmation. As soon as we receive your payment, we will ship you the merchandise.

•Invoice

We will send you an invoice with the shipment. The invoice amount is payable without deductions within 14 days (private customers) or 30 days (business customers). We reserve the right to request pre-payment when it comes to first-time or large-value orders. We will then send you an invoice for pre-payment. This will also be enforced in case of larger outstanding balances. In certain cases, for justifiable reasons, such as a credit check, to reduce credit and default risks, to combat abuse or collect outstanding bills, we transmit your data to a credit information institute and receive the necessary data from the providers. Please note our data privacy statement.

•Credit card (Master Card, VISA, American Express), Maestro

Payment will be completed at the end of the order over a secure connection.

•Sofort.

After the order is placed, you will be transferred to the Klarna page. Payment requires a bank account that is enabled for online banking, your PIN and your TAN.

•PayPal

Payment will be completed at the end of the order over a secure connection.

•Apple Pay

You pay your order via Apple Pay. This payment option will only appear if you have already set up Apple Pay.

•Amazon Pay

Payment will be completed at the end of the order over a secure connection.

Security during paymentThe PCI DSS certificate attests that supermagnete.de meets the high security requirements of the payment card industry.

Minimum order

The minimum order amount is EUR 15,00 (including VAT, not including shipping costs).

Contact

Our Mailing Address (not a store!):

supermagnete.de

Webcraft GmbH

Industriepark 206

78244 Gottmadingen

Germany

Tel. +49 7731 939 839 2

support@supermagnete.de